

# Higher- $T_c$ Superconductivity from Density Functional Calculations

Lilia Boeri

*Max-Planck-Institute for Solid State Physics,  
Stuttgart, Germany*



*Program on the Physics of Higher- $T_c$  superconductivity,  
KITP, Santa Barbara, 13/08/2009*

# Higher T<sub>c</sub> superconductivity, General Questions:

? What is the **Physics** of high-T<sub>c</sub> superconductors?

Can we understand SC **pairing** and the **phase diagram** ?

? What is the **Chemistry** of high-T<sub>c</sub> superconductors?

What makes higher-T<sub>c</sub> superconductor **special** ?

? How can we **improve** existing **materials**?

## What can we learn from DFT?

! Normal-state properties can be calculated *ab-initio*:  
Is **standard LDA** enough or do we need to go **beyond** ?

! Understand the **electronic structure** of HTSC

! Tune material properties via simulation.

# Outline:

Higher  $T_c$  superconductivity, when **DFT works...**

**Electron-Phonon (BCS) superconductors:** the pairing mechanism is understood, but how can we improve the materials?

A simple example, **doping graphite...**

And when it **doesn't work...**

**Exotic Superconductors:** role of strong local ( $U$ ) and non-local ( $HF$ ) correlations, dynamic fluctuations...

A recent example, **iron pnictides...**

Can we still learn something, and **how do we go beyond?**

# When DFT works: Electron-Phonon SC ...

The SC pairing is well understood (Migdal-Eliashberg Theory):

AND

The **Eliashberg spectral function** can be calculated from first-principles using **Density Functional Perturbation Theory**:

$$\alpha^2 F(\Omega) = \frac{1}{N(0)} \sum_{\mathbf{k}\mathbf{k}',\alpha} \delta(\varepsilon_{\mathbf{k}}) \delta(\varepsilon_{\mathbf{k}'}) |g_{\mathbf{k}\mathbf{k}'}^{\alpha}|^2 \delta(\Omega - \omega_{\mathbf{k}-\mathbf{k}'})$$

Electronic  
structure

E-ph  
Matrix Elements

Phonon  
Spectra

Can we use DFT to understand and predict new SC?

(See also ICMR school talk from Warren Pickett )

# Graphite:

a simple system with many surprises!

Carbon  $p_z$  anti-bonding orbital

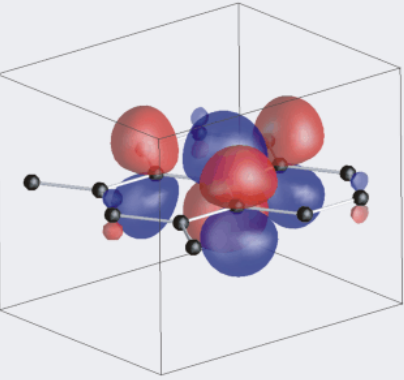

Carbon  $p_z$ -bonding orbital

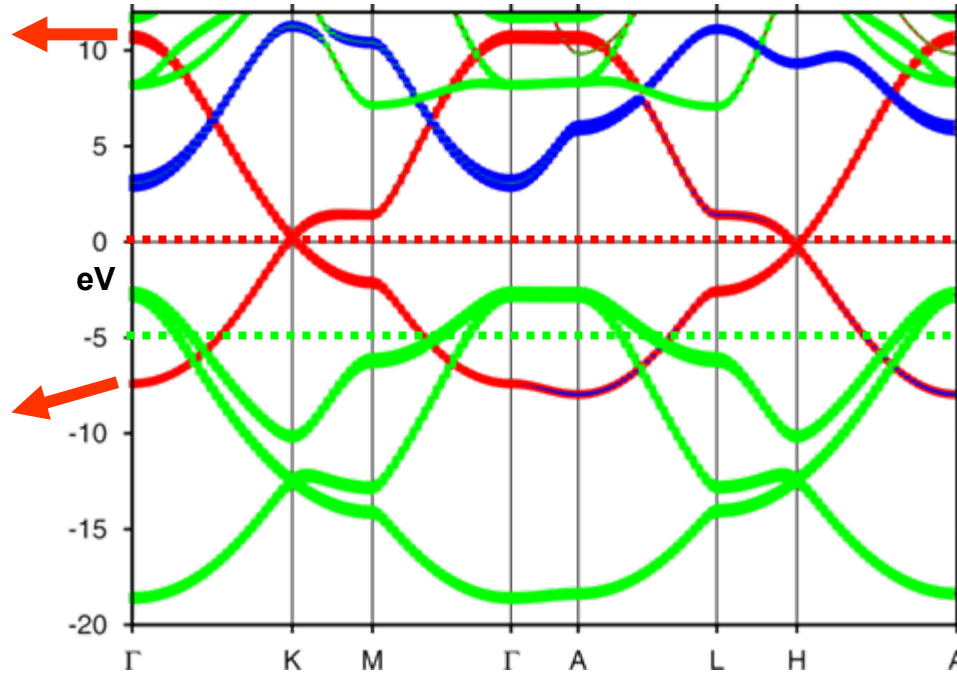
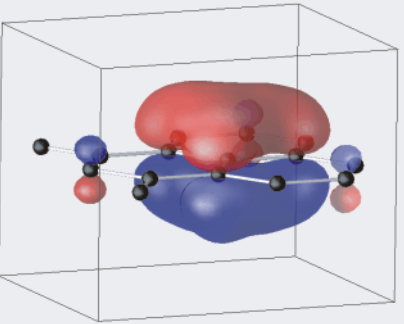

Carbon  $sp^2$ -bond orbital

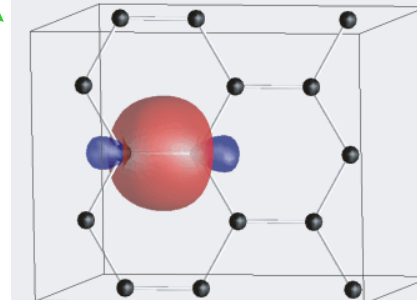

**Undoped:** EF is at the **Dirac point** -> semimetal, no sc.

**Hole Doping ( $MgB_2$ ):** EF sits in the  $\sigma$  bands -> Strong coupling to bond-stretching phonons ->  $T_c=40$  K!

# Hole Doping: MgB<sub>2</sub>

Phonon dispersions and line widths due to electron-phonon-interaction

Eliashberg functions:

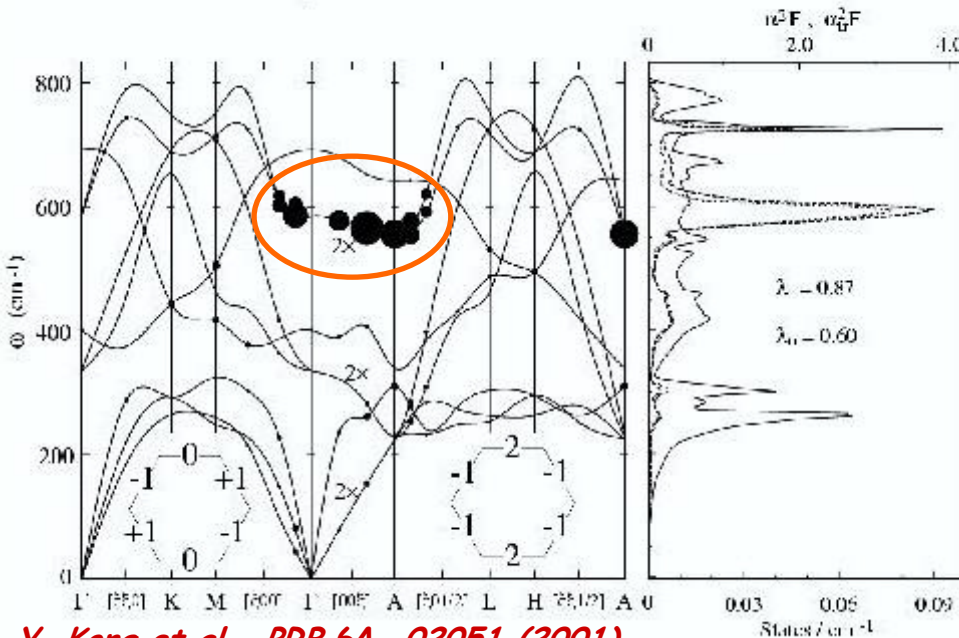

Y. Kong et al., PRB 64, 02051 (2001)

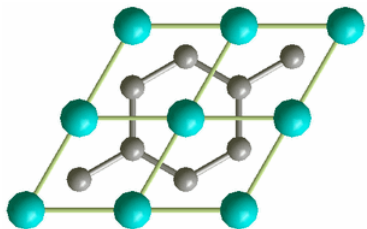

Strong **geometrical coupling** between bond-stretching modes and stiff  $\sigma$  bonds!

• Total e-ph interaction  $\lambda=0.8-0.9$ : concentrated in a doubly-degenerate Bond-stretching mode <- **graphite!**

$$D = \left. \frac{d\varepsilon_k}{du} \right|_{E_F} = 12eV/\text{\AA}$$

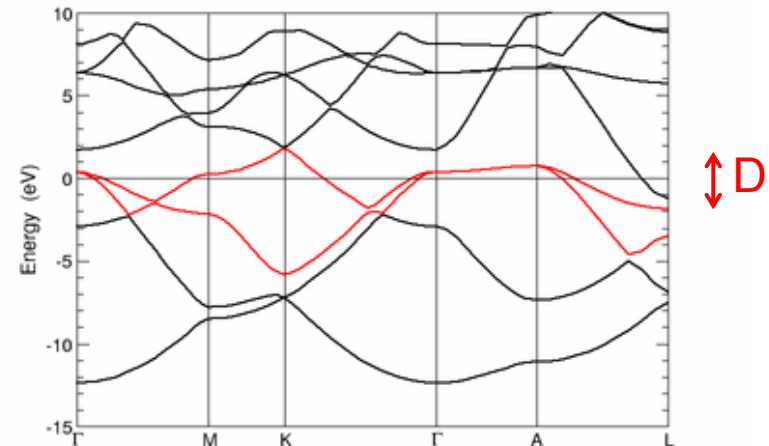

Carbon  $p_z$  anti-bonding orbital

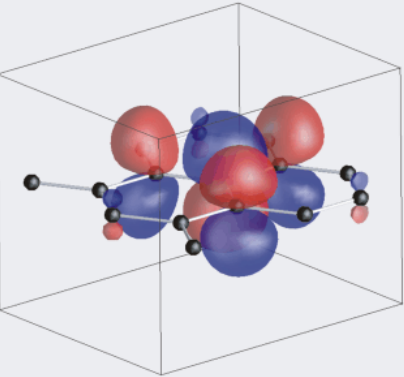

Carbon  $p_z$ -bonding orbital

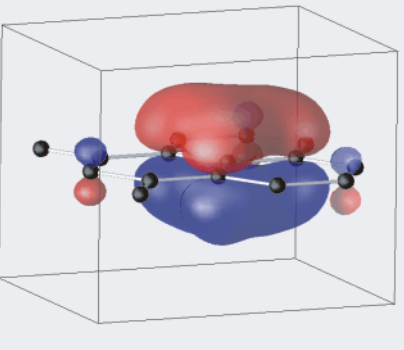

# Graphite:

a simple system with many surprises!

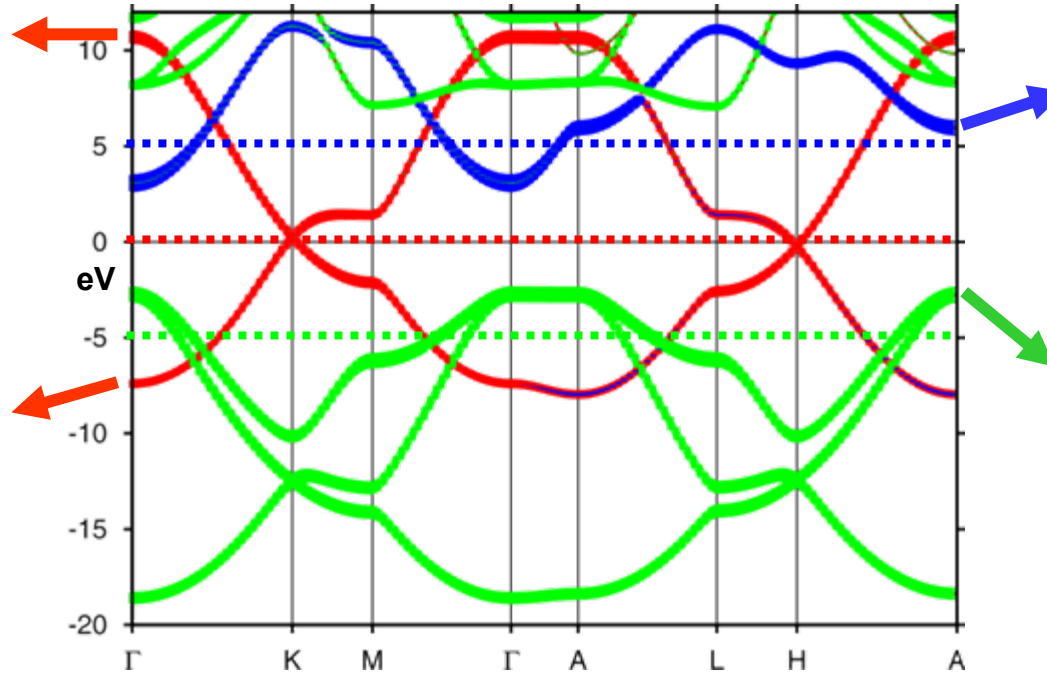

Interlayer orbital

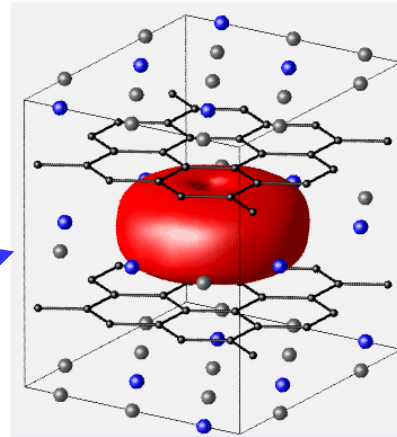

Carbon  $sp^2$ -bond orbital

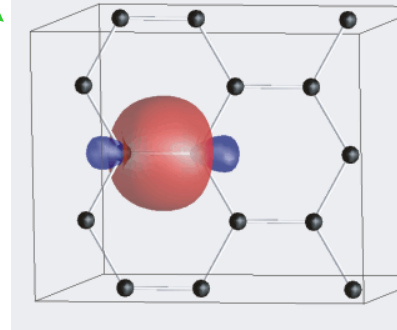

**Undoped:** EF is at the **Dirac point** -> semimetal, no sc.

**Hole Doping ( $MgB_2$ ):** EF sits in the  **$\sigma$  bands** ->  $T_c=40$  K!

*T.E. Weller, et al., Nature Physics 1, 39 (2005).*

**Electron Doping ( $CaC_6$ ):** EF sits in the **IL +  $\pi^*$  bands** ->  $T_c \leq 15$  K!

*T.E. Weller, et al., Nature Physics 1, 39 (2005).*

# Plasmons or electron-phonon?

! In all graphite intercalation compounds which are **superconducting** the **interlayer band** is full...



The IL electrons behave like free electrons...



Plasmon-mediated superconductivity?

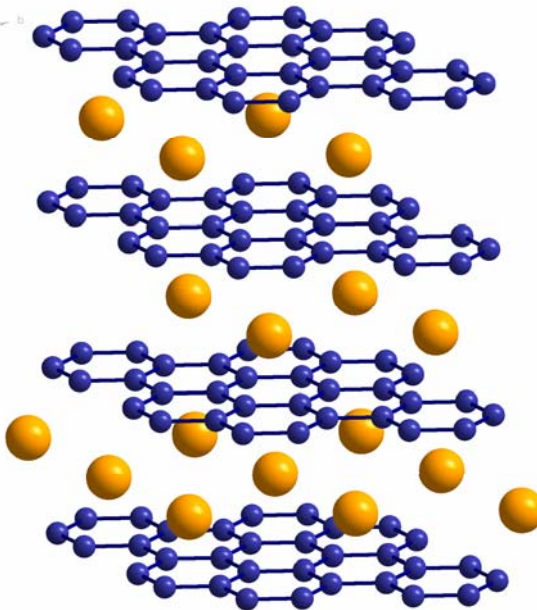

**Dielectric**

**2D Metal**

**Dielectric**

**2D Metal**

**Dielectric**

**2D Metal**

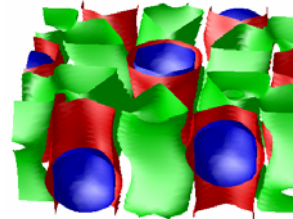

**NO!**

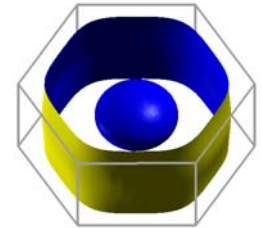

- 1) **Interlayer** electrons have a **3D** dispersion
- 2) Interlayer electrons **can interact** with **graphite phonons** even without an intercalant!



# Where does the electron-phonon coupling come from?

? What happens if we dope pure graphite (i.e. without intercalants?)

! Replacing the intercalant with jellium (2/3 e- for every C atom), we can feel the interlayer band. 2 types of bands at EF: interlayer +  $\pi^*$

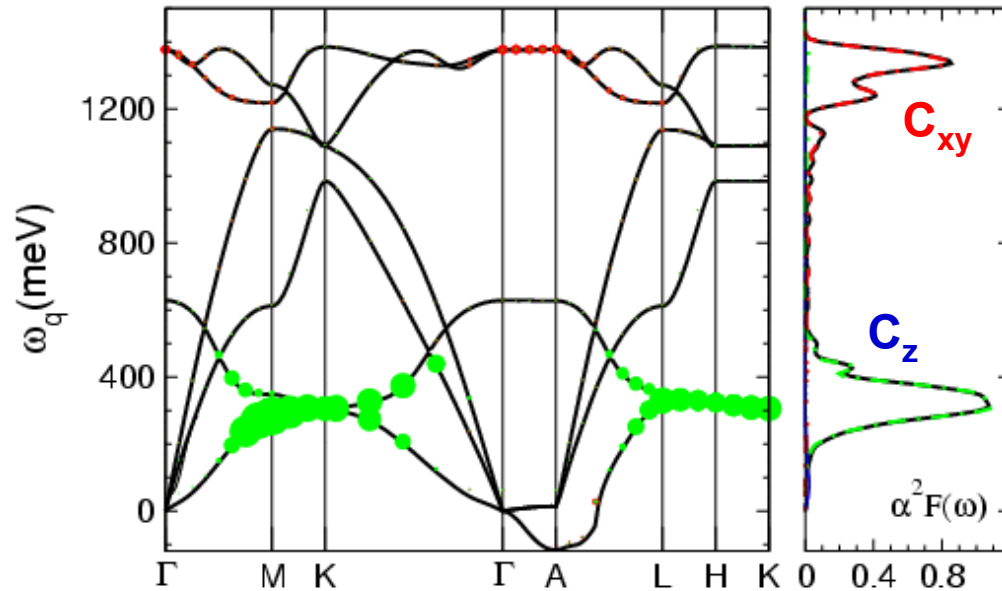

2 peaks in  $\alpha^2 F(\omega)$ !!!

80% of  $\lambda$  from  $C(z)$  modes

$$\lambda_{\text{tot}} = 1.01$$

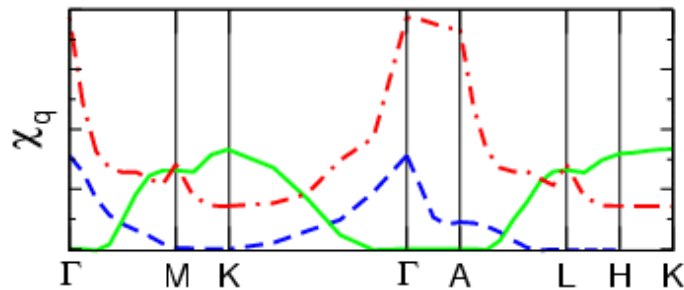

In this case we exploit the **dormant interaction** between  $\pi^*$  states and interlayer band!!

## In summary...

In BCS-like superconductors, where the superconducting pairing is understood and electronic correlations are negligible, ab-initio calculations represent a valuable tool to search for new superconductors...

**Graphite:** High  $T_c$  occurs when **dormant electron-phonon interactions** are awakened by the appropriate band filling...



**DOPE INTO STRONG COVALENT BONDS!**

The search for new materials can be driven by **chemical/empirical methods...**

...or completely *ab-initio*:

Predicting Crystal Structures by

Random Searching (C. Pickard)

Genetic Algorithms (A. Oganov)

Data Mining of Quantum Computations (Cedered, Curtarolo)

---

PHYSICAL REVIEW B 73, 180501(R) (2006)

Prediction of different crystal structure phases in metal borides: A lithium monoboride analog to  $\text{MgB}_2$

Aleksey N. Kolmogorov and Stefano Curtarolo

*Engineering and Materials Science, Duke University, Durham, North Carolina 27708, USA*

(Received 2 March 2006; published 5 May 2006)

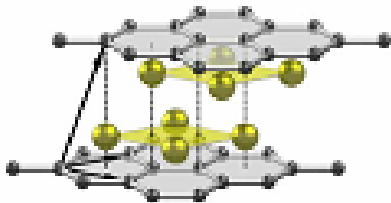

b) MS1

When DFT doesn't work: what can we learn?

A case study, Fe pnictides (and chalcogenides)

**EXP:** Broad class of compounds, containing SC Fe(As) layers. Tc up to 55 K. Rich phase diagram: SC, magnetism and structural transitions.



**Early DFT Results:** Basic Electronic Structure, E-ph Coupling, Nesting, Magnetism and Structural Transitions

**BUT**

Problems in reconciling DFT with experiment...

**WHY?**

**How do we go beyond?**

# Fe pnictides, basic electronic structure:

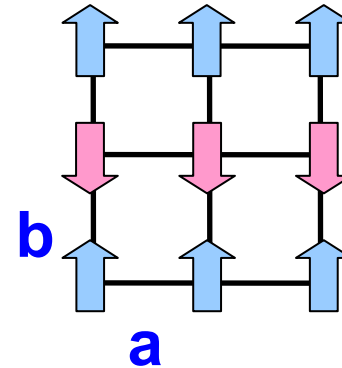
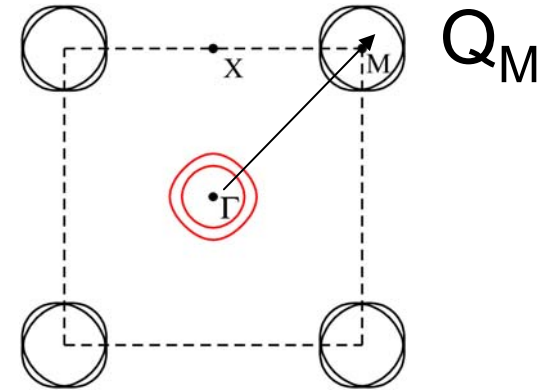
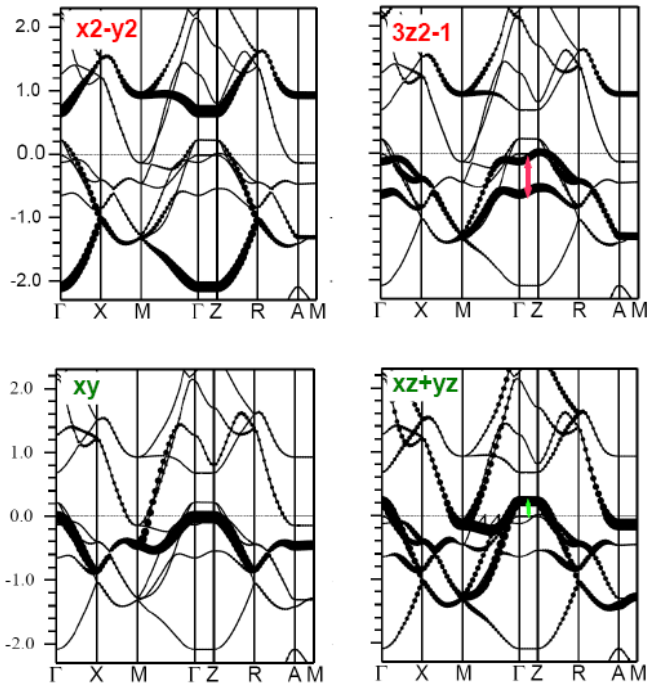

- The 10 bands around EF are derived by the 2x5 Fe-d orbitals
- No clear separation between  $e_g$  and  $t_{2g}$  bands (tetrahedral splitting).
- Strong modulation of the bands with Fe-As hoppings.
- 2 holes + 2 electron Fermi surfaces; ~ perfect nesting!
- Ground state is an AFM striped metal, with  $m=2 \mu_B$

See D.J. Singh's, P. Hirschfeld's and O.K. Andersen's talks

# Can e-ph interaction explain $T_c$ in FeAs compounds?c

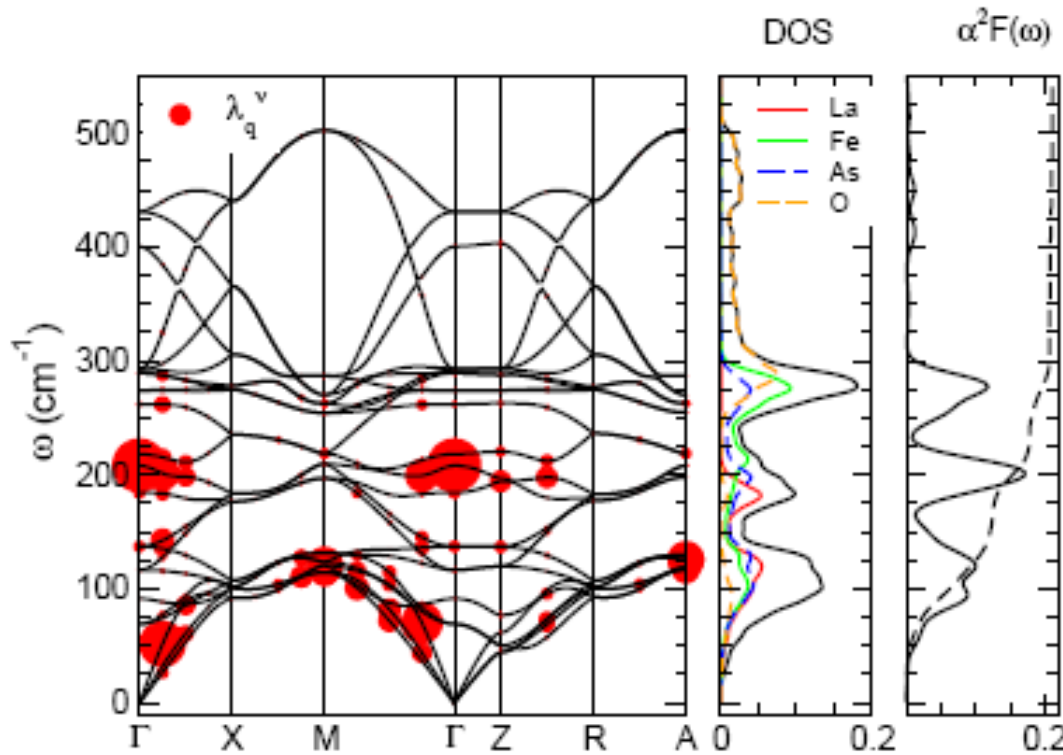

$$\lambda = 0.21$$

$$\omega_{\log} = 206K$$

$$T_c^{ME} (\mu^* = 0) = 0.5K$$

**NO!**

- **E-ph interaction:**  $\lambda \sim 0.2$  is **too small** to account for  $T_c$
- Doping can only decrease  $\lambda$ .
- $N(0)$  is large,  $\lambda$  is small because of **small e-ph matrix elements**.

LDA gives a reasonable description of the **normal state properties** of Fe SC...

**BUT**

PHYSICAL REVIEW B 78, 085104 (2008)



Problems with reconciling density functional theory calculations with experiment in ferropnictides

Magnetic moments predicted by DFT are **too large** compared with **experiment**

Magnetic moments depend sizably on the **crystal structure**

Optimization of the crystal structure in the non magnetic phase is **wrong**

**What is DFT telling us?**

In order to explain  $T_c$ , we need to understand the superconducting mechanism...

**How can we go beyond?**

A **critical** look at the electronic structure: what are the **crucial details**? (see also Ole Andersen's talk)

## 1) Crystal Structure and chemistry:

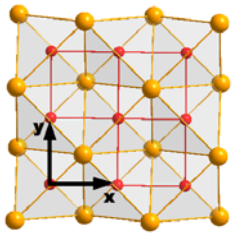

Two details are crucial: presence of **Fe(Pn/Ch)** planes + band filling ( $d^6$ ); the magnetic/SC properties of other MPn compounds can be basically understood in a rigid band picture.

Electronic and magnetic properties of Mn, Fe, Co, Ni and Zn in LaTPnO

<i>TM</i>	Mn		Fe		Co		Ni		(Cu)	Zn	
<i>Pn</i>	P	As	P	As	P	As	P	As		P	As
Elect. Prop.	Mott Insulator		Superconductor		Metal		Superconductor		—	Semiconductor	
Magnetism	AFM				FM				—	Non-magnetic	
$E_g$	-1 eV		—		—		—		—	-1.5 eV	
$T_C$ (SC)	> 400 K		Undoped: 4 K	F-doped: 26 K	43 K	66 K	Undoped: 3 K	Undoped: 2.4 K		—	
$T_{N,C}$ (Mag.)											
Ref.	Yanagi et al. JAP (submitted)		Kanihara et al. JACS(2006), Kanihara et al. JACS (2008)		Yanagi et al. PRB (2008)		Watanabe et al. IC (2007), Watanabe et al. JSSC (2007)		—	Kayanuma et al. PRB (2007), Kayanuma et al. TSP (2008)	

Fig. 10. Electromagnetic and optical properties elucidated in LaT<sub>0.5</sub>PnO.



## 2) Bonding:

As orbitals are **extended** and long-ranged: strong **Fe-As** hybridization + long range of the hoppings.

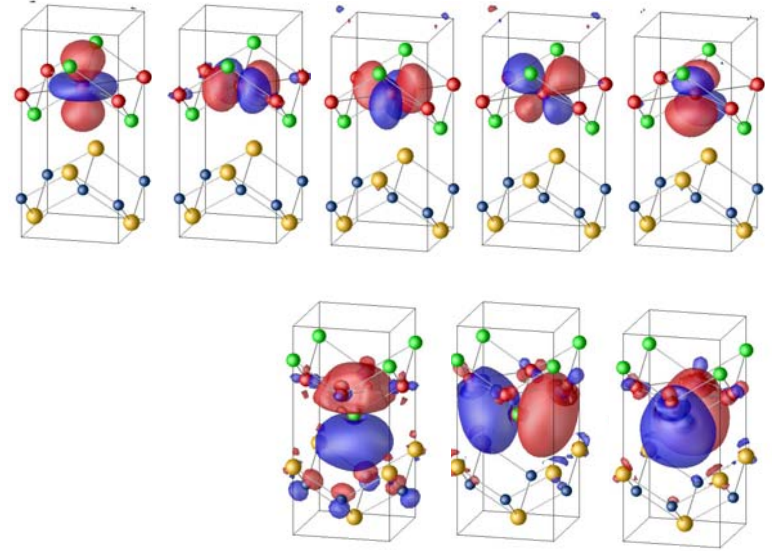

Fe-As hybridization is large: Polarizability model, based on the picture of “**tightly bound Fe 3d electrons propagating in a lattice of rather isolated As negative ions**” probably does not apply.

Long-range hoppings -> free-electron like masses  
Electrons are strongly delocalized -> itinerant rather than local picture.

### 3) Magnetism, weak or strong coupling?

Band structure susceptibility (stripe order) of La 1111; the exchange splitting is a free parameter.

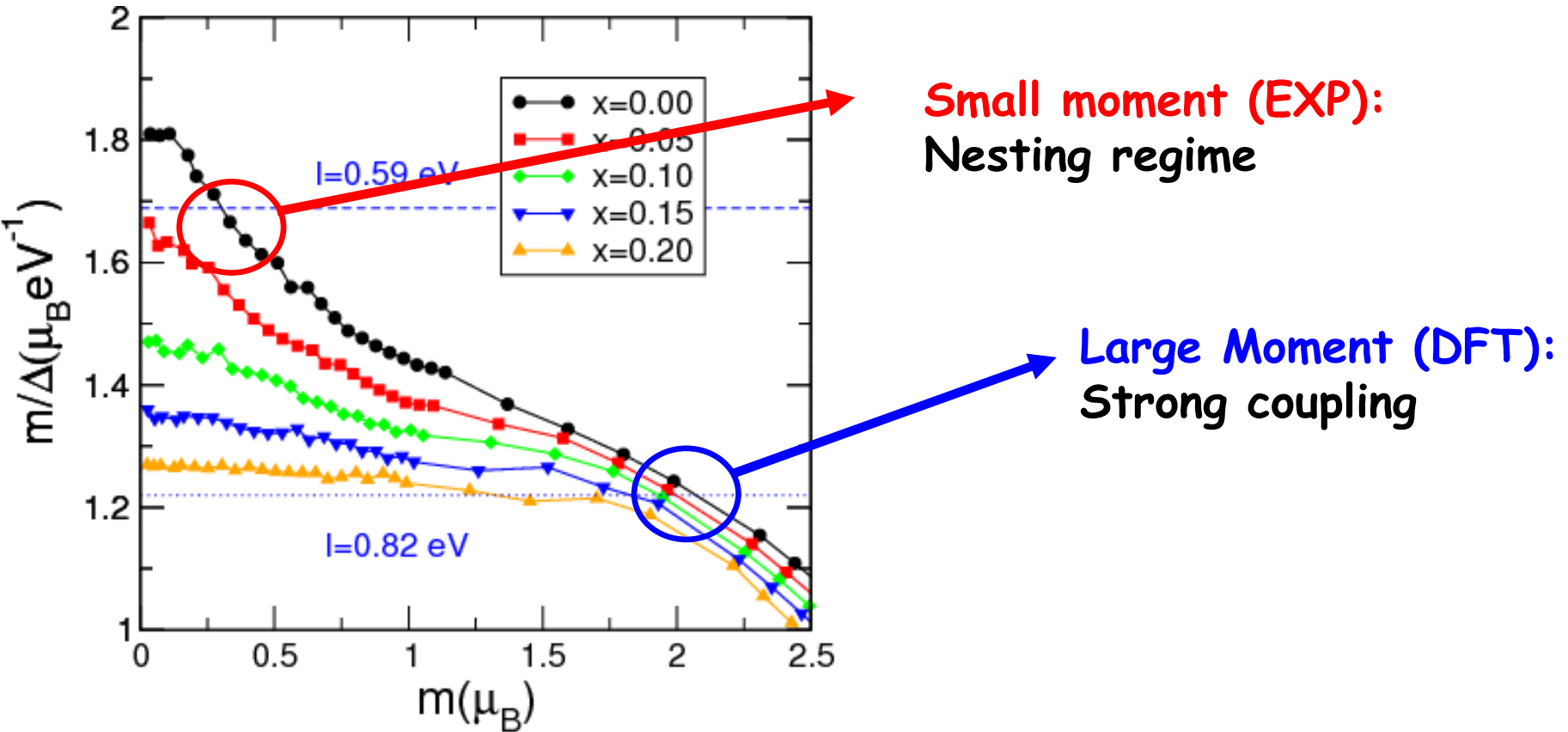

Possible reasons for disagreement: LDA is overestimating the Stoner parameter, or fluctuations suppress the effective magnetic moment.

### 3) Magnetism, weak or strong coupling?

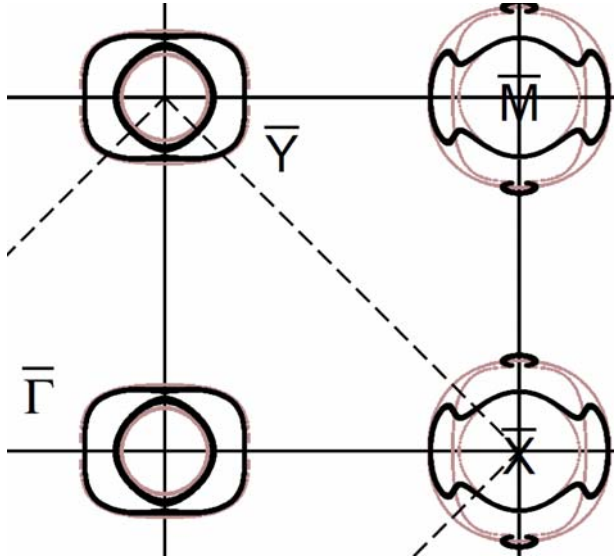

**Small moment:** Partial reconstruction of the FS (nesting)

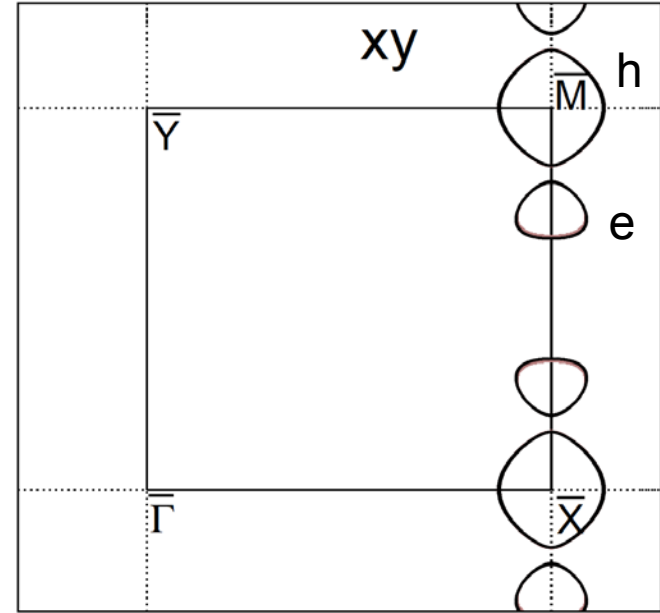

**Large moment:** Total reconstruction of the FS; states at EF have different orbital character.

### 3) Origin of the magnetic moment:

Partial Band structure susceptibility (stripe order) of La 1111.

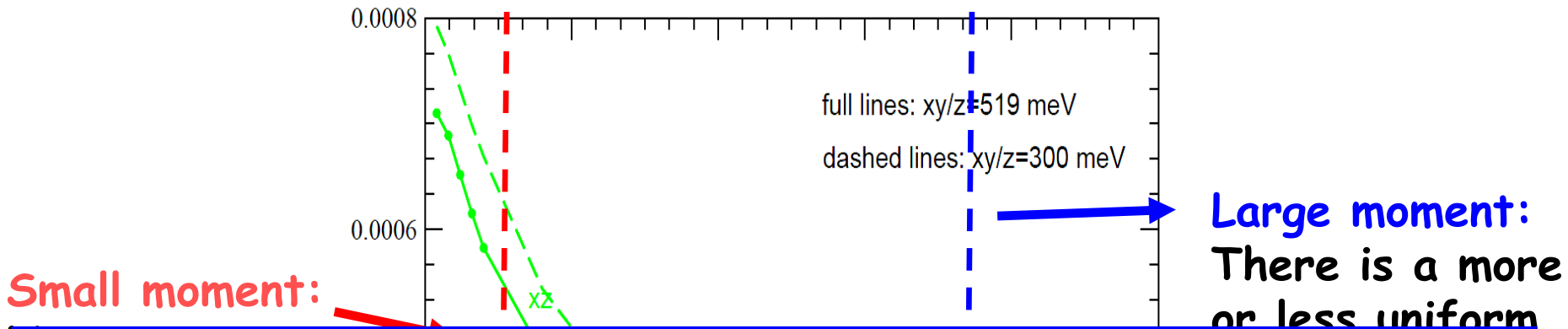

The large magnetic moment ( $2 \mu_B$ ) is not due to electron localization (Hubbard physics); electrons in the AFM state are still delocalized -> once more, **local picture is NOT correct !!!!**

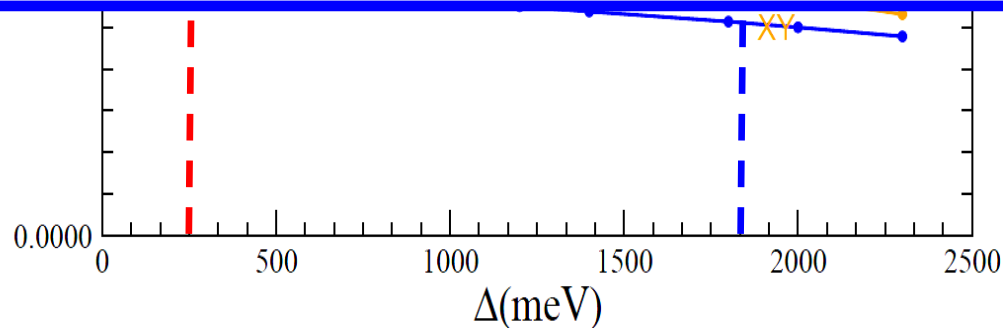

### 3) Magnetism and lattice (effect of Fe-As hybridization):

Inclusion of the magnetic moment in the calculations is crucial to lead the correct structure (tetragonal distortion + Fe-As distance)

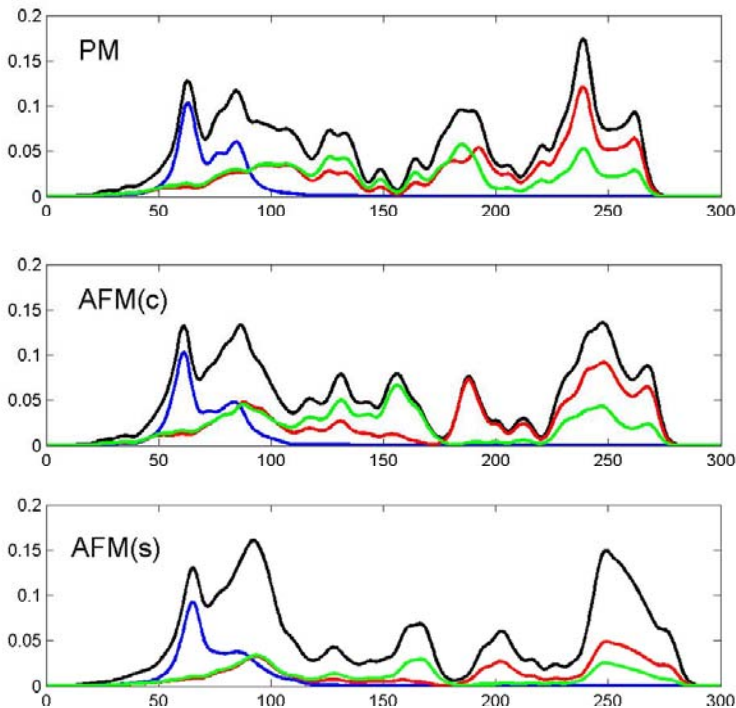

**AND**

Improves the agreement between theory and experiment for phonon properties -> mainly affect Fe and As modes.

Ba-122, effect of magnetism on phonon DOS.

# In summary...

In **Fe pnictides** DFT calculations cannot explain SC...

**BUT**

They impose important **constraints** on the microscopic models:

Strong Fe-As hybridization  
+ long-range hopping

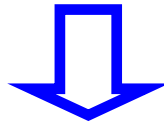

Lattice structure and dynamics seem to suggest a large magnetic moment suppressed by fluctuations...

Even for large magnetic moments local picture is not correct...

# Search for higher $T_c$ superconductors:

**Electron-Phonon (BCS) superconductors:** Current DFT methods work fine, the big challenge is optimize the material properties -> ab-initio prediction of new compounds?

**Exotic Superconductors:** Current DFT methods seem to fail for different reasons:

**BKBO:** non-local exchange; negative  $U$  due to large e-ph interaction?

**Cuprates:** lack of Hubbard physics (large local Coulomb repulsion).

**Pnictides:** delocalized electrons with large magnetic moment, suppressed by fluctuations -> dynamic effects?

**THANK YOU!!!**



# And also thanks to...

## Theory:

- G.B. Bachelet, *Università la Sapienza, Roma, Italy*
- J. Kortus, *TU Bergakademie Freiberg*
- M. Giantomassi, *Université Catholique de Louvain, Belgium*
- O.V. Dolgov, *MPI-FKF,*
- A.A. Golubov, *Univ. Twente, the Netherlands.*
- M. Johannes, I.I. Mazin, *NRL Washington, USA*
- O.K. Andersen, *MPI-FKF, Stuttgart*
- M. Calandra (Paris)

## Experiment:

- J.S. Kim, R.K. Kremer, *MPI-FKF, Stuttgart*; F.S. Razaavi, *Brock Univ., Canada*