

LHC PHYSICS @ 1% PRECISION?

Gavin Salam, CERN

*LHC Run II and the Precision Frontier
Experimental Challenges for the LHC Run II
KITP, UCSB, March 30, 2016*

CONTEXT

Progress on calculations has been stunning in the past years

- N3LO Higgs
- Many processes at NNLO
- NLO + PS automation
- First NNLO + PS
- NNLL Resummations
- EW + QCD, etc.

This progress is essential for LHC precision physics, but also only part of the story.

The intention with this talk?

Start asking questions about what precision goals we might set ourselves, what obstacles we will meet, what techniques and measurements might help us progress

**What precision should we
have as a target?**

HIGGS TODAY & TOMORROW

Production process	ATLAS+CMS
μ_{ggF}	$1.03^{+0.17}_{-0.15}$
μ_{VBF}	$1.18^{+0.25}_{-0.23}$
μ_{WH}	$0.88^{+0.40}_{-0.38}$
μ_{ZH}	$0.80^{+0.39}_{-0.36}$
μ_{ttH}	$2.3^{+0.7}_{-0.6}$

ATLAS-CMS Run I combination

*In most cases, stat. errors
are largest single source*

Best channels $\sim \pm 20\%$

Decay channel	ATLAS+CMS
$\mu^{\gamma\gamma}$	$1.16^{+0.20}_{-0.18}$
μ^{ZZ}	$1.31^{+0.27}_{-0.24}$
μ^{WW}	$1.11^{+0.18}_{-0.17}$
$\mu^{\tau\tau}$	$1.12^{+0.25}_{-0.23}$
μ^{bb}	$0.69^{+0.29}_{-0.27}$

HL-LHC prospects?

x2.5 in cross section
x150 in luminosity ($\rightarrow 3000 \text{ fb}^{-1}$)
 ~ 400 times more events

\Rightarrow stat. errors in 1-2% range

DI-HIGGS PRODUCTION AT HL-LHC ($HH \rightarrow 4b, 3ab^{-1}$)

Behr, Bortoletto, Frost, Hartland, Issever & Rojo, 1512.08928

Category		signal	background		$S/\sqrt{B_{\text{tot}}}$	$S/\sqrt{B_{4b}}$	S/B_{tot}	S/B_{4b}
		N_{ev}	$N_{\text{ev}}^{\text{tot}}$	N_{ev}^{4b}				
Boosted	no PU	290	$1.2 \cdot 10^4$	$8.0 \cdot 10^3$	2.7	3.2	0.03	0.04
	PU80+SK+Trim	290	$3.7 \cdot 10^4$	$1.2 \cdot 10^4$	1.5	2.7	0.01	0.02
Intermediate	no PU	130	$3.1 \cdot 10^3$	$1.5 \cdot 10^3$	2.3	3.3	0.04	0.08
	PU80+SK+Trim	140	$5.6 \cdot 10^3$	$2.4 \cdot 10^3$	1.9	2.9	0.03	0.06
Resolved	no PU	630	$1.1 \cdot 10^5$	$5.8 \cdot 10^4$	1.9	2.7	0.01	0.01
	PU80+SK	640	$1.0 \cdot 10^5$	$7.0 \cdot 10^4$	2.0	2.6	0.01	0.01
Combined	no PU				4.0	5.3		
	PU80+SK+Trim				3.1	4.7		

Key signal channels will need ~1% control of complex bkgds

DATA-DRIVEN BKGD ESTIMATES: NON-SMOOTHNESS AT 1% LEVEL



Predictions at high invariant masses.

As we all know, bump hunts in the diphoton system assume a smooth function which can be fitted to the data. Begging the question,

How smooth is smooth? :-)

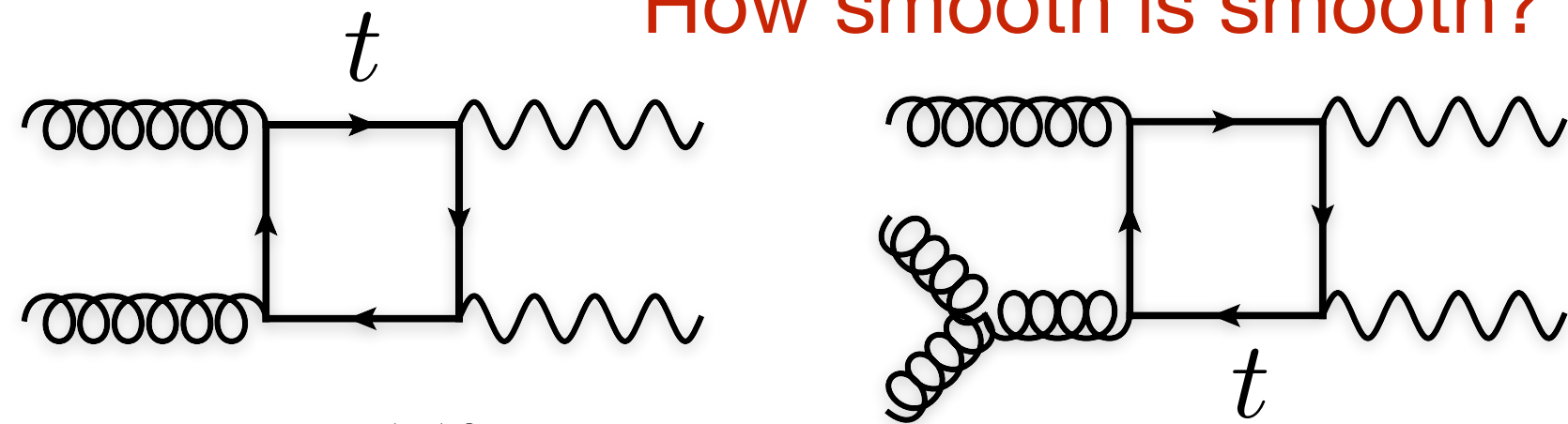

*C. Williams
Moriond QCD '16*

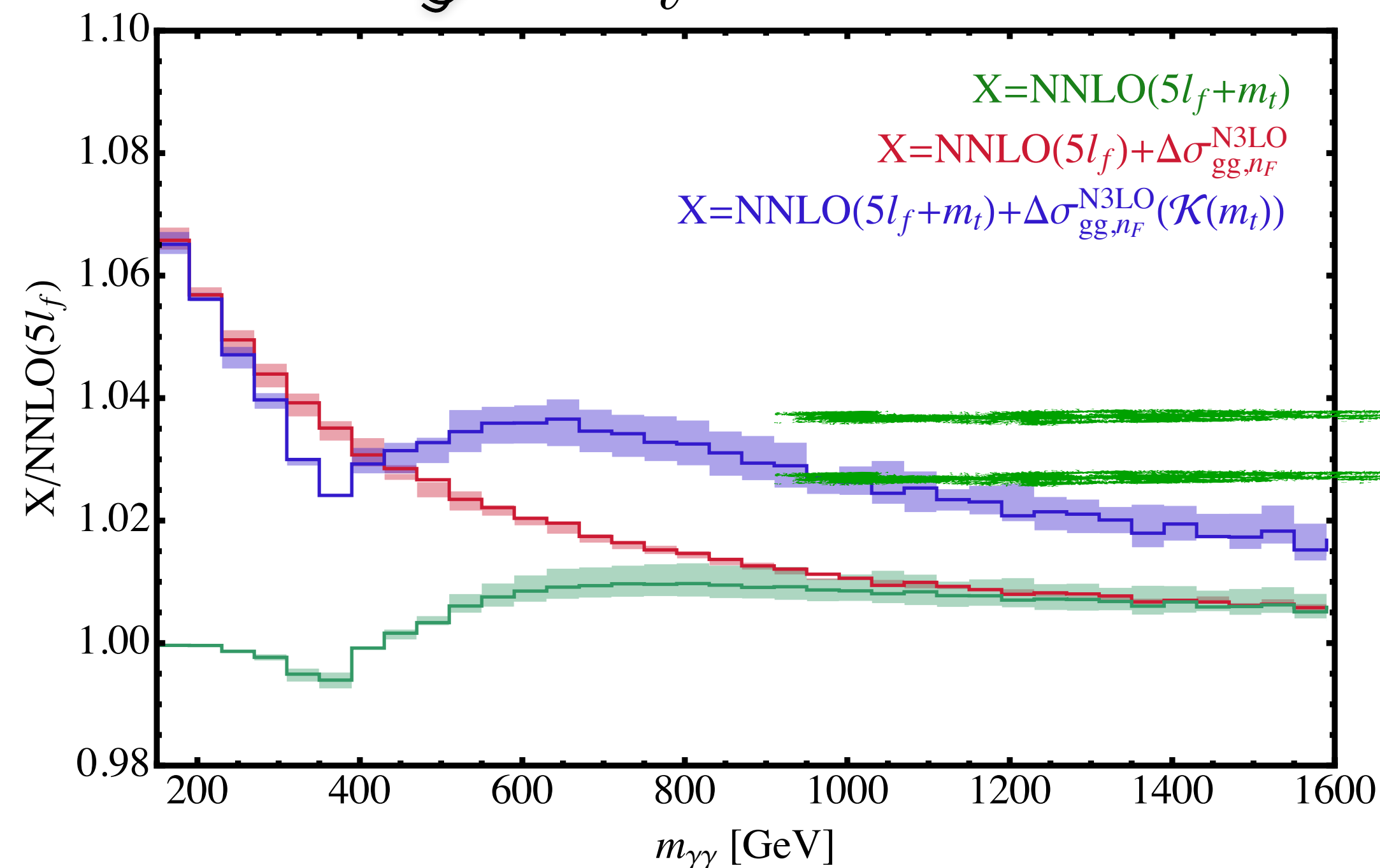

1%

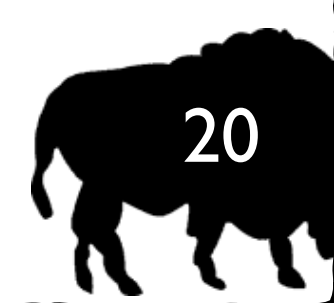

Standard experimental techniques, like data-driven bkgd estimates, can be skewed by 0(1%) theoretical subtleties.

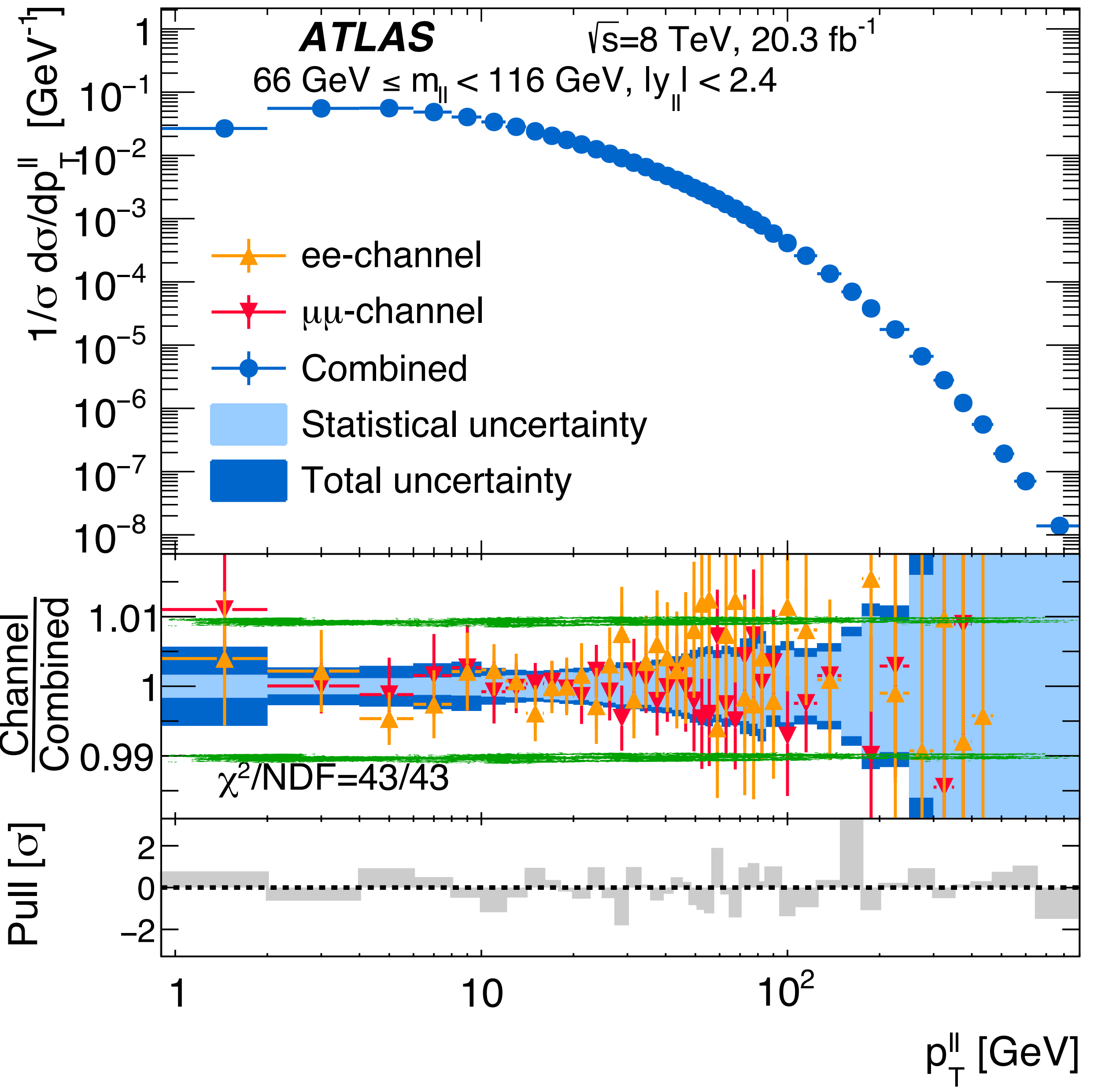

WHAT'S POSSIBLE EXPERIMENTALLY?

Today's most precise results are perhaps for the Z transverse momentum

- normalised to Z fiducal σ
- achieves $<1\%$, from $p_T = 1$ to 200 GeV

$\pm 1\%$

Ratio to total cross section cancels lumi & some lepton-efficiency systematics.

Top quark pair, CMC-PDFs, LHC 14 TeV

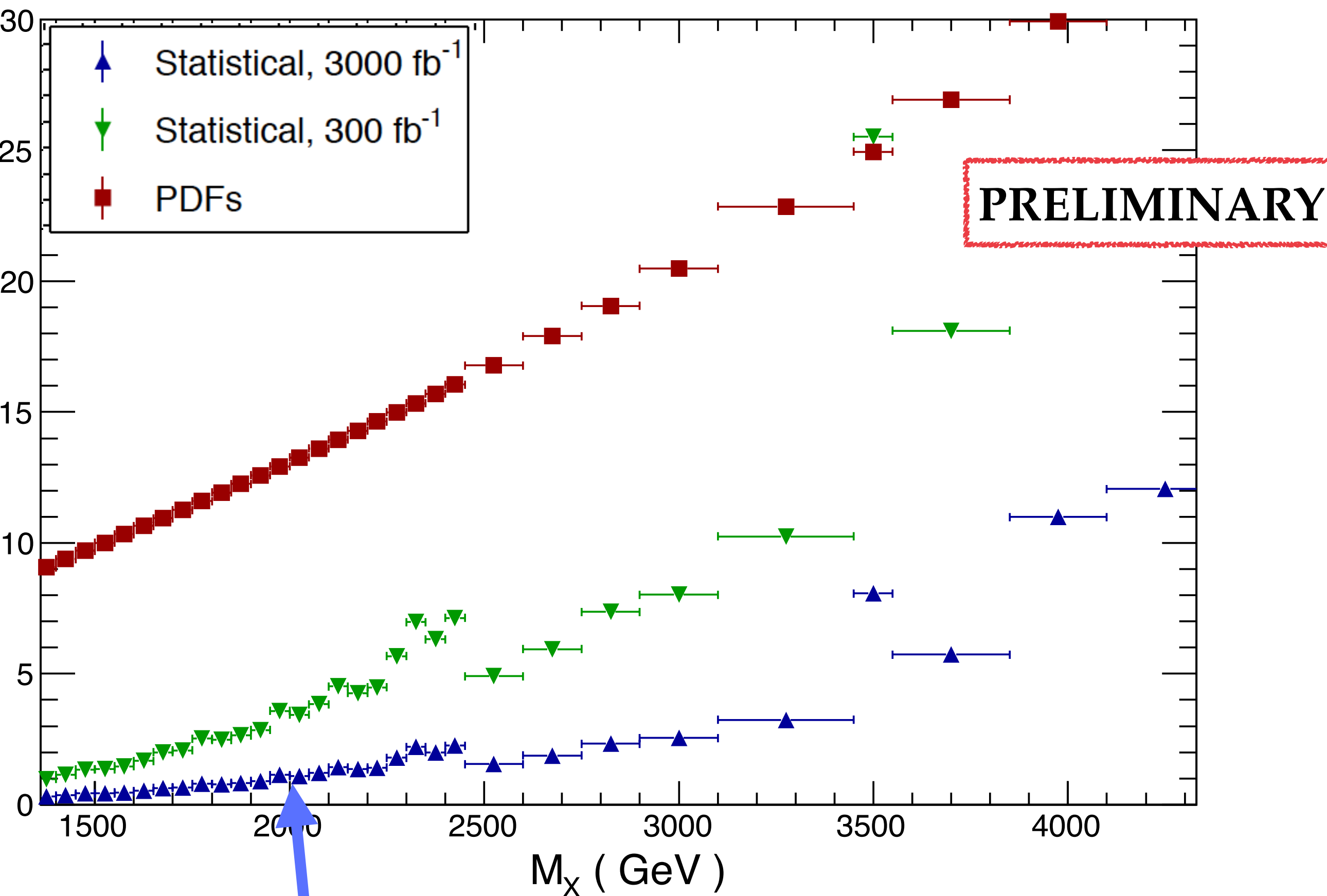

Juan Rojo

HL-LHC workshop, CERN, 13/05/2015

At HL-LHC, Statistical errors on $t\bar{t}$ production will be $< 1\%$ up to $M_{t\bar{t}} \sim 2 \text{ TeV}$

IN THE FUTURE?

- high-pt W, Z
- high-mass Drell-Yan
- high-mass $t\bar{t}$

Will all be at $\sim 1\%$ statistical level up to and even beyond the TeV scale.

With leptonic final states, there's a chance systematic errors may also be $< 1\%$.

OVERALL, 1% SEEMS AN INTERESTING FIGURE TO HAVE IN MIND

To start thinking about getting there, let's work through the “**inputs**”:

- the strong coupling
- PDFs

And the **types of process**:

- inclusive / purely leptonic
- processes with jets

Input parameters?

Concentrate on α_s

PDG World Average: $\alpha_s(M_Z) = 0.1181 \pm 0.0013$ (1.1%)

Bethke, Dissertori & GPS in PDG '16

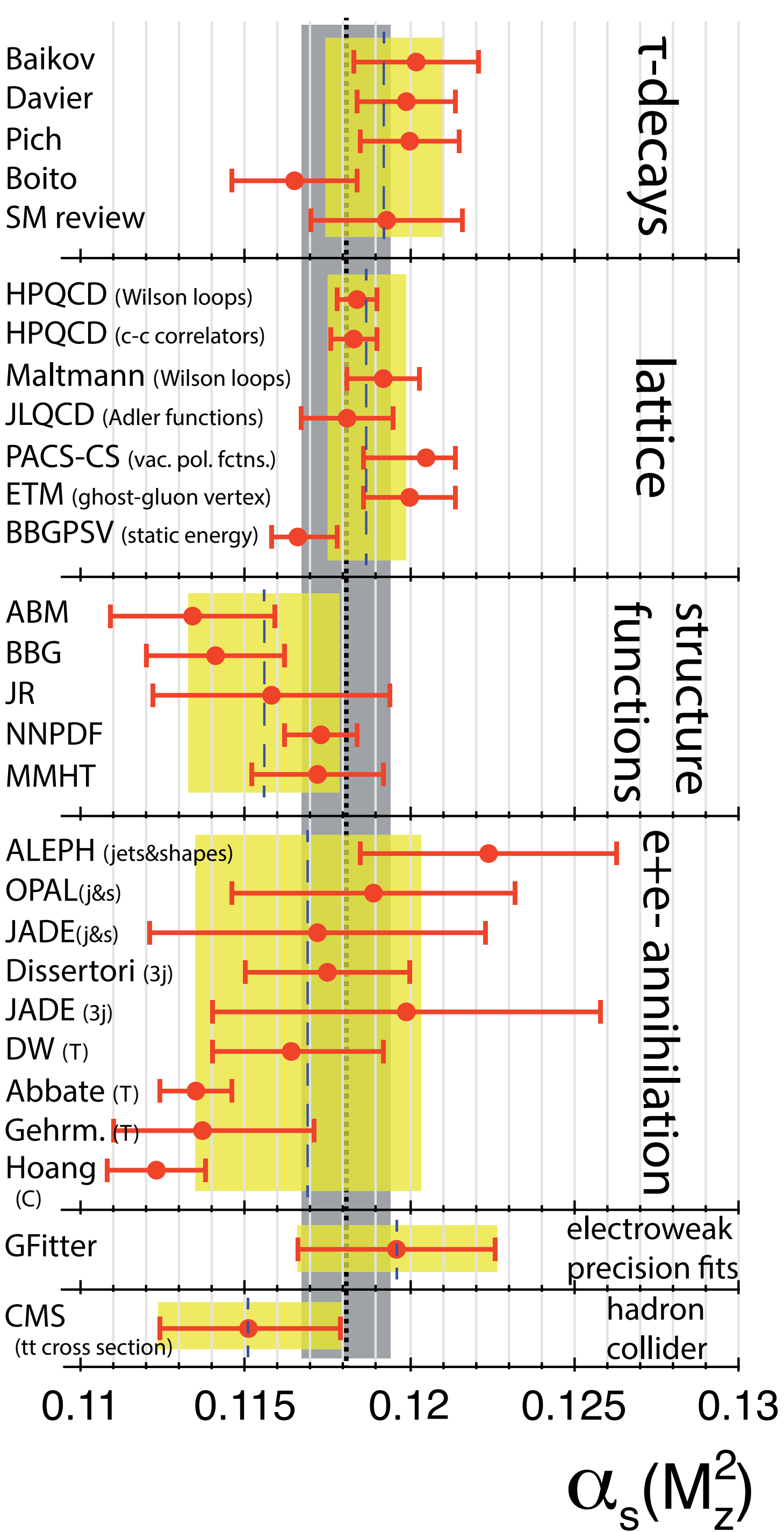

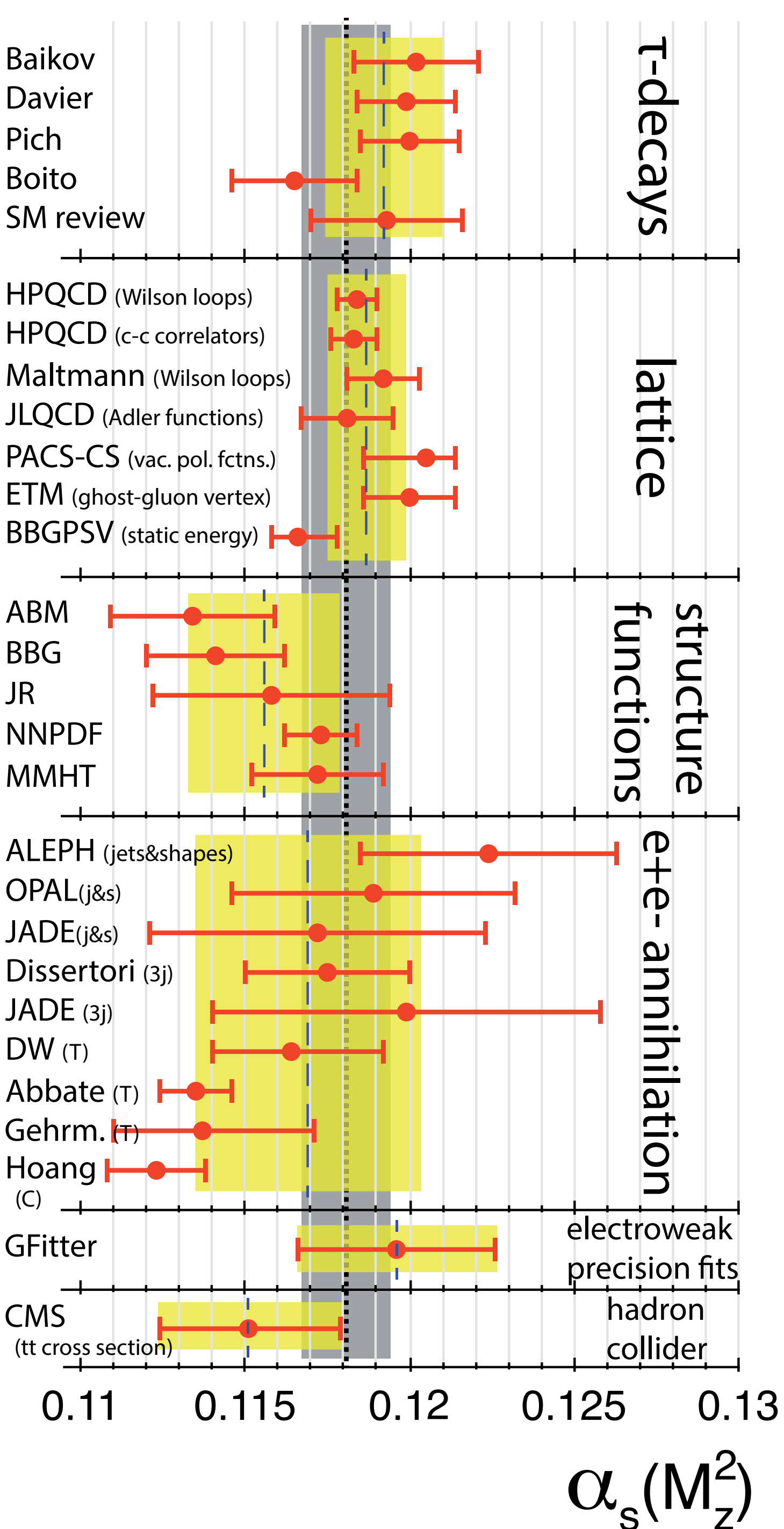

PDG World Average: $\alpha_s(M_Z) = 0.1181 \pm 0.0013$ (1.1%)

- Most consistent set of independent determinations is from lattice
- Two best determinations are from same group (HPQCD, 1004.4285, 1408.4169)

$\alpha_s(M_Z) = 0.1183 \pm 0.0007$ (0.6%) [heavy-quark correlators]

$\alpha_s(M_Z) = 0.1183 \pm 0.0007$ (0.6%) [Wilson loops]

- Error criticised by FLAG, who suggest

$\alpha_s(M_Z) = 0.1184 \pm 0.0012$ (1%)

- Worries include missing perturbative contributions, non-perturbative effects in 3–4 flavour transition at charm mass [addressed in some work], etc.

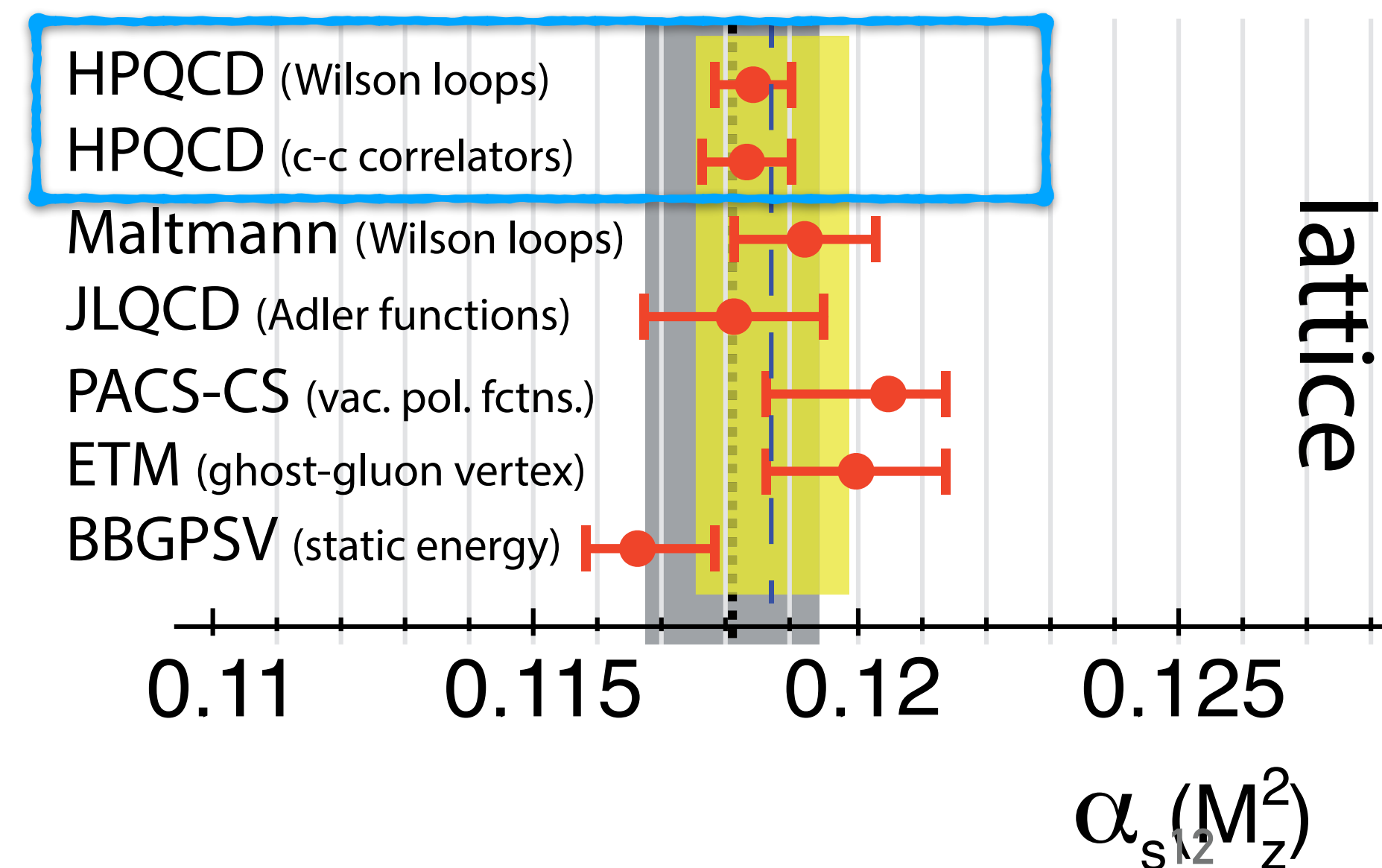

E+E- EVENT SHAPES AND JET RATES

- Two “best” determinations are from same group

(Hoang et al, 1006.3080,1501.04111)

$$\alpha_s(M_Z) = 0.1135 \pm 0.0010 \text{ (0.9\%)} \text{ [thrust]}$$

$$\alpha_s(M_Z) = 0.1123 \pm 0.0015 \text{ (1.3\%)} \text{ [C-parameter]}$$

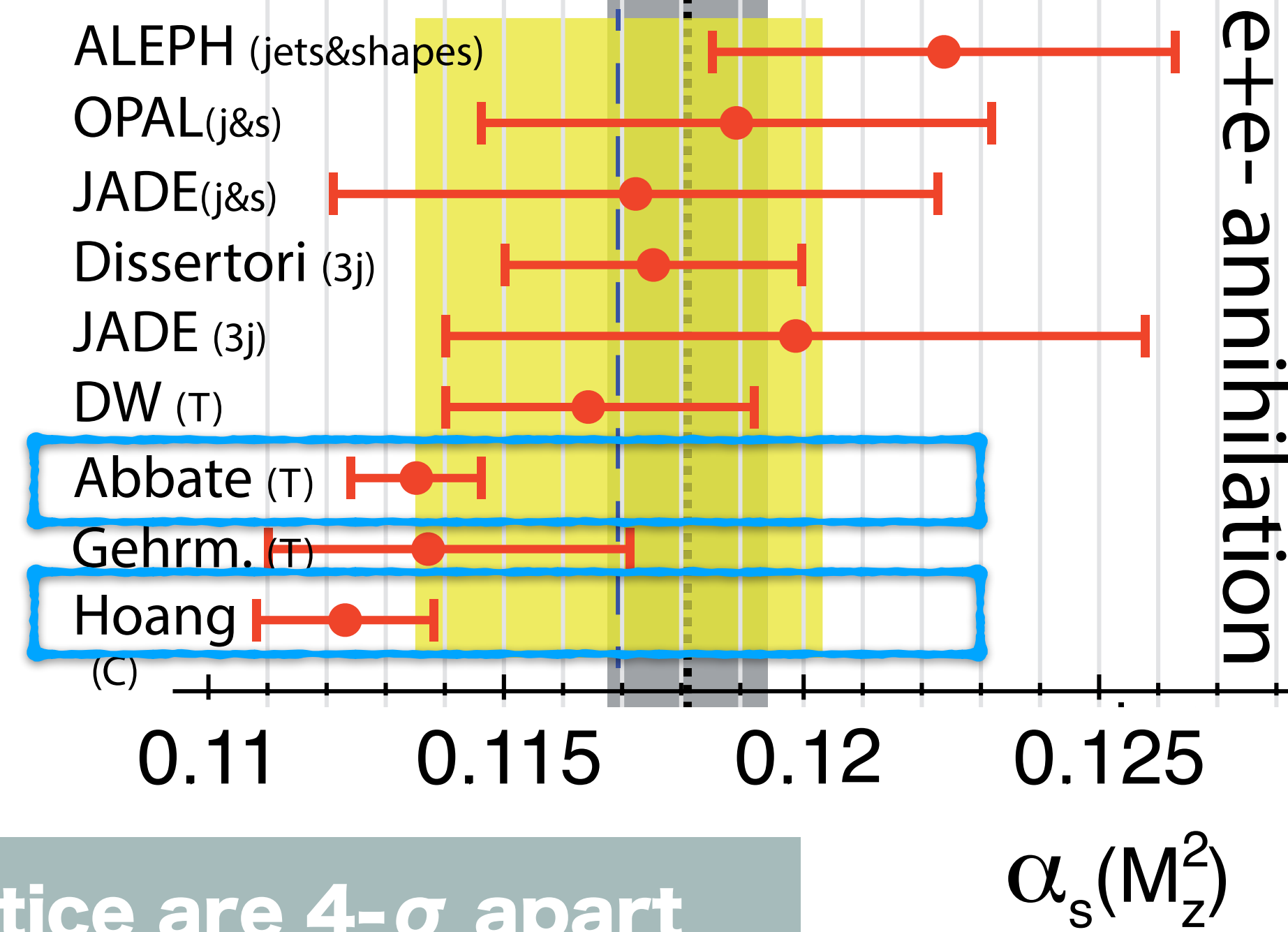

thrust & “best” lattice are 4- σ apart

E+E- EVENT SHAPES AND JET RATES

- Two “best” determinations are from same group (Hoang et al, 1006.3080, 1501.04111)

$$\alpha_s(M_Z) = 0.1135 \pm 0.0010 \text{ (0.9\%)} \text{ [thrust]}$$

$$\alpha_s(M_Z) = 0.1123 \pm 0.0015 \text{ (1.3\%)} \text{ [C-parameter]}$$

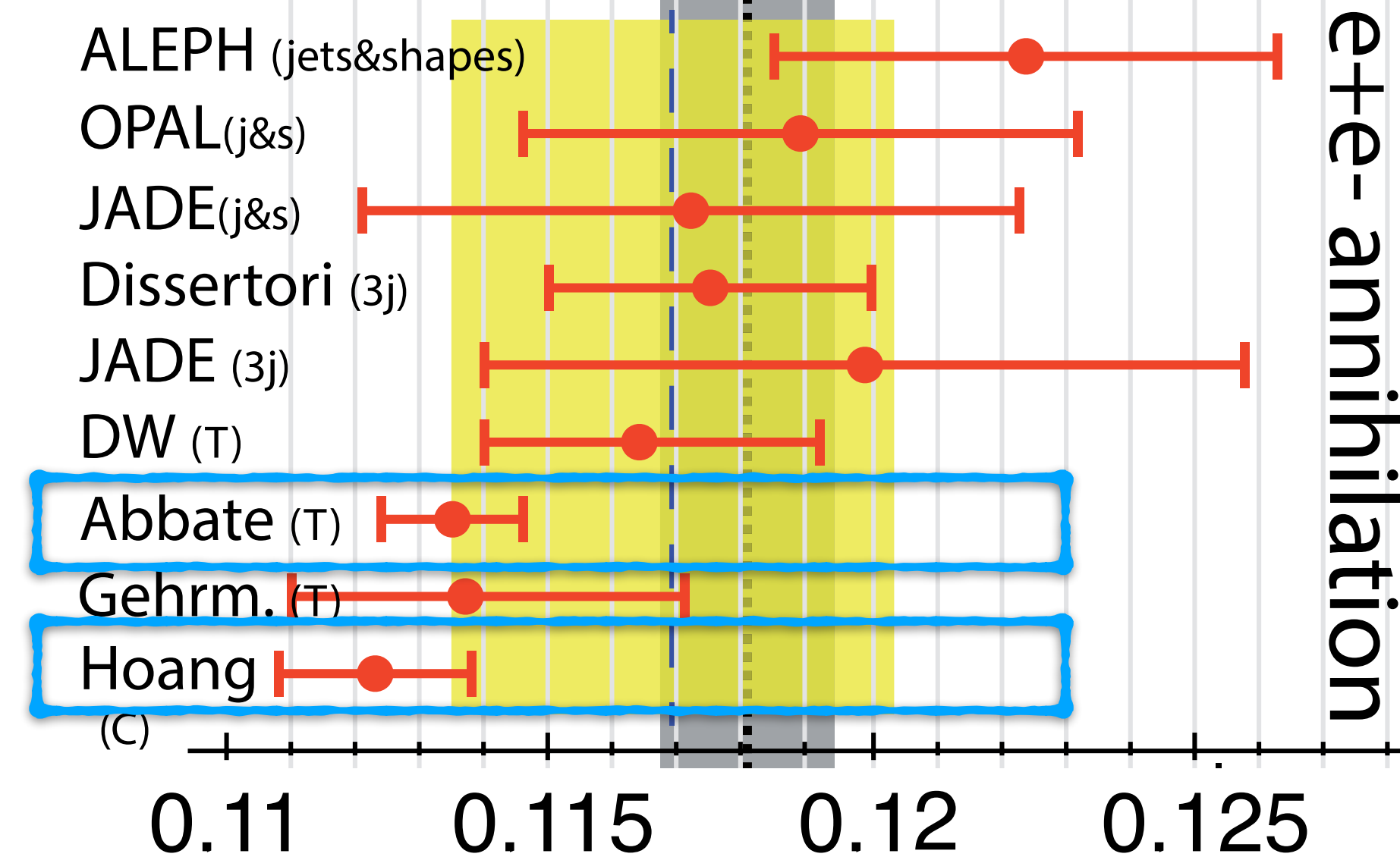

e+e- annihilation

thrust & “best” lattice are 4- σ apart

Comments:

- thrust & C-parameter are highly correlated observables
- Analysis valid far from 3-jet region, but not too deep into 2-jet region — at LEP, not clear how much of distribution satisfies this requirement
- thrust fit shows noticeable sensitivity to fit region (C-parameter doesn't)

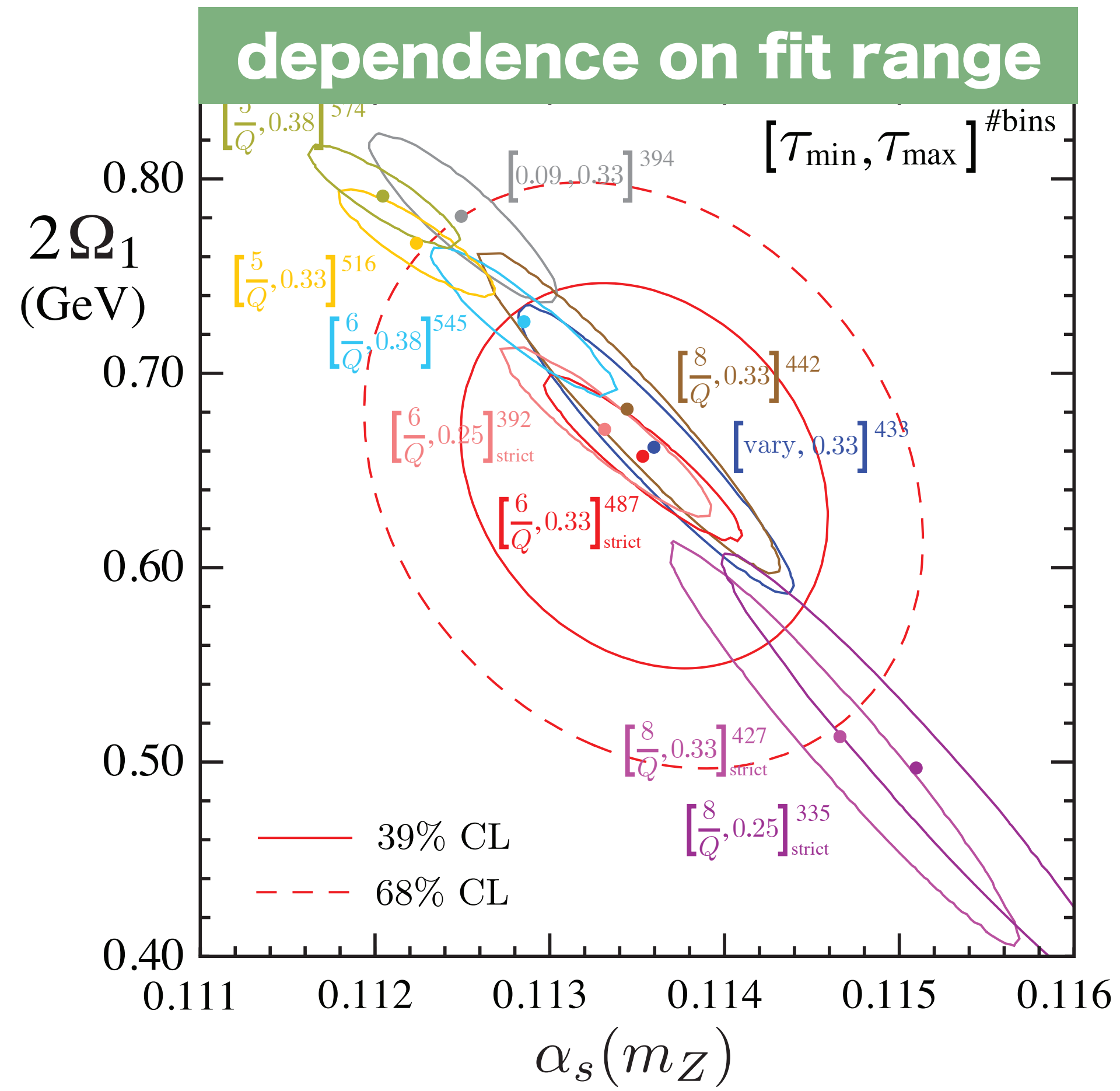

WHAT WAY FORWARDS FOR α_s ?

- ▶ We need to settle question of whether “small” (0.113) α_s is possible. LHC data already weighing in on this (top data), further info in near future ($Z p_T$, cf. later slides)
- ▶ To go beyond 1%, best hope is probably lattice QCD — on a 10-year timescale, there will likely be enough progress that multiple groups will have high-precision determinations

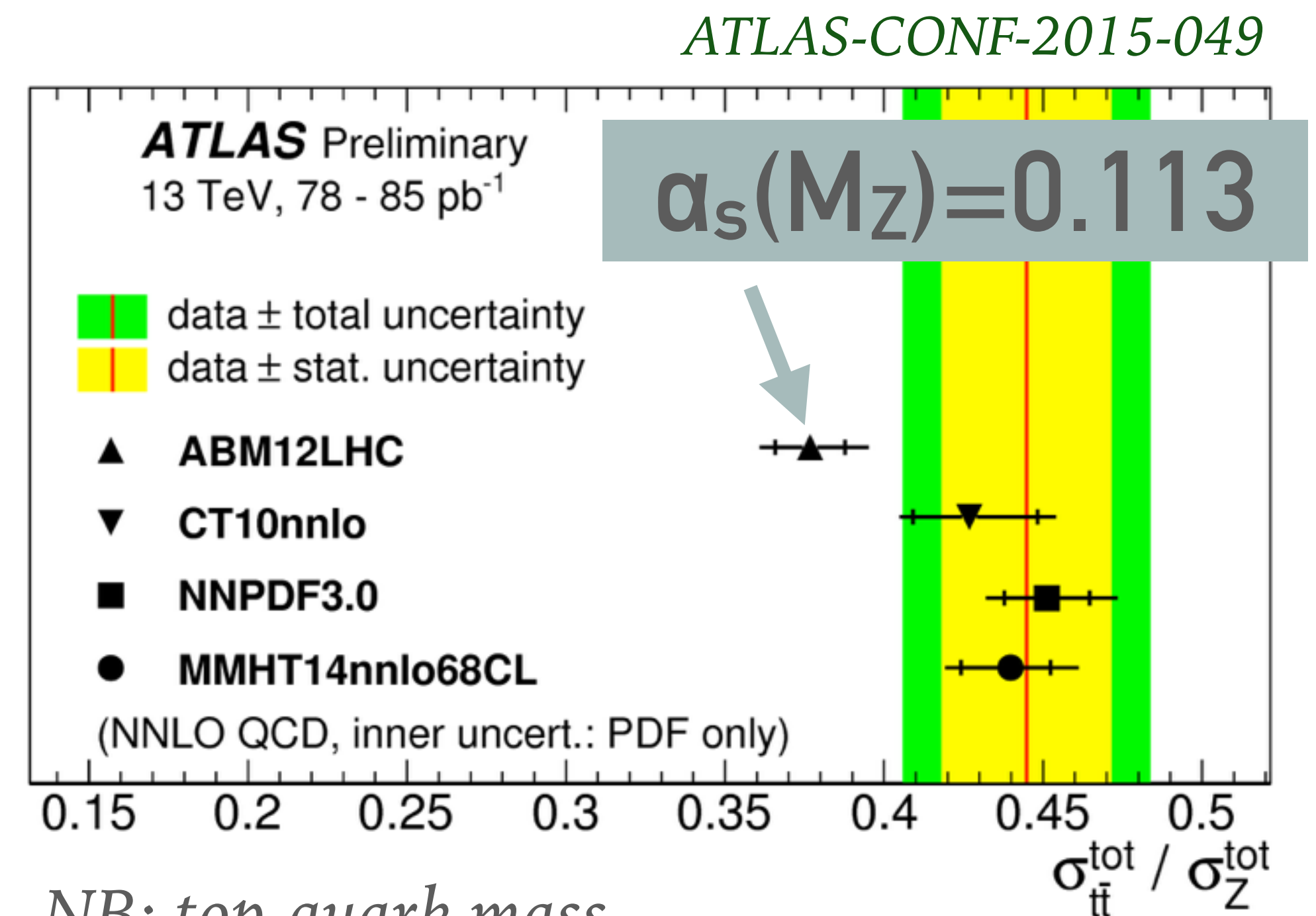

NB: top-quark mass choice affects this plot

PDFs

UNCERTAINTIES ON PARTONIC LUMINOSITIES — V. RAPIDITY(y) AND MASS

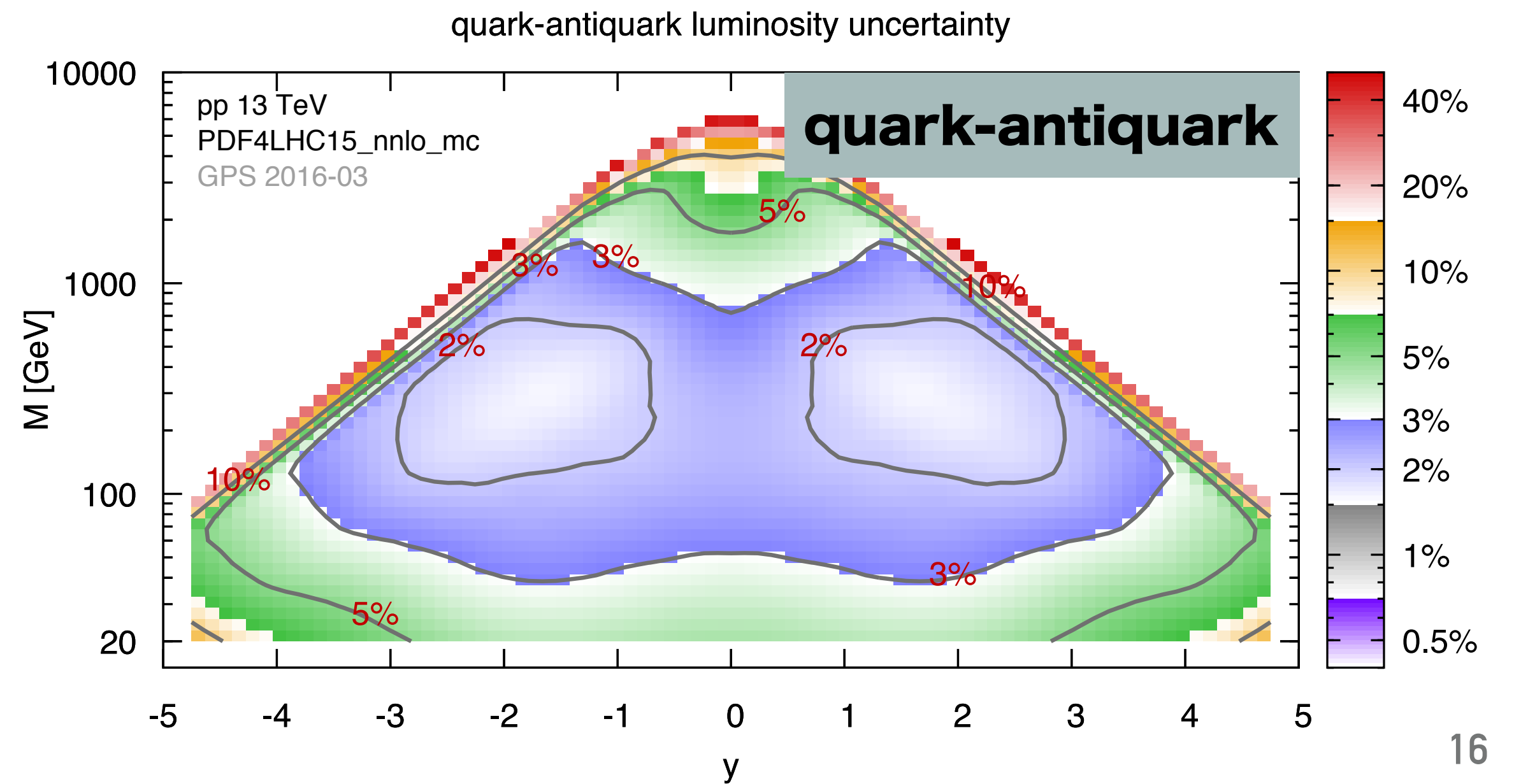
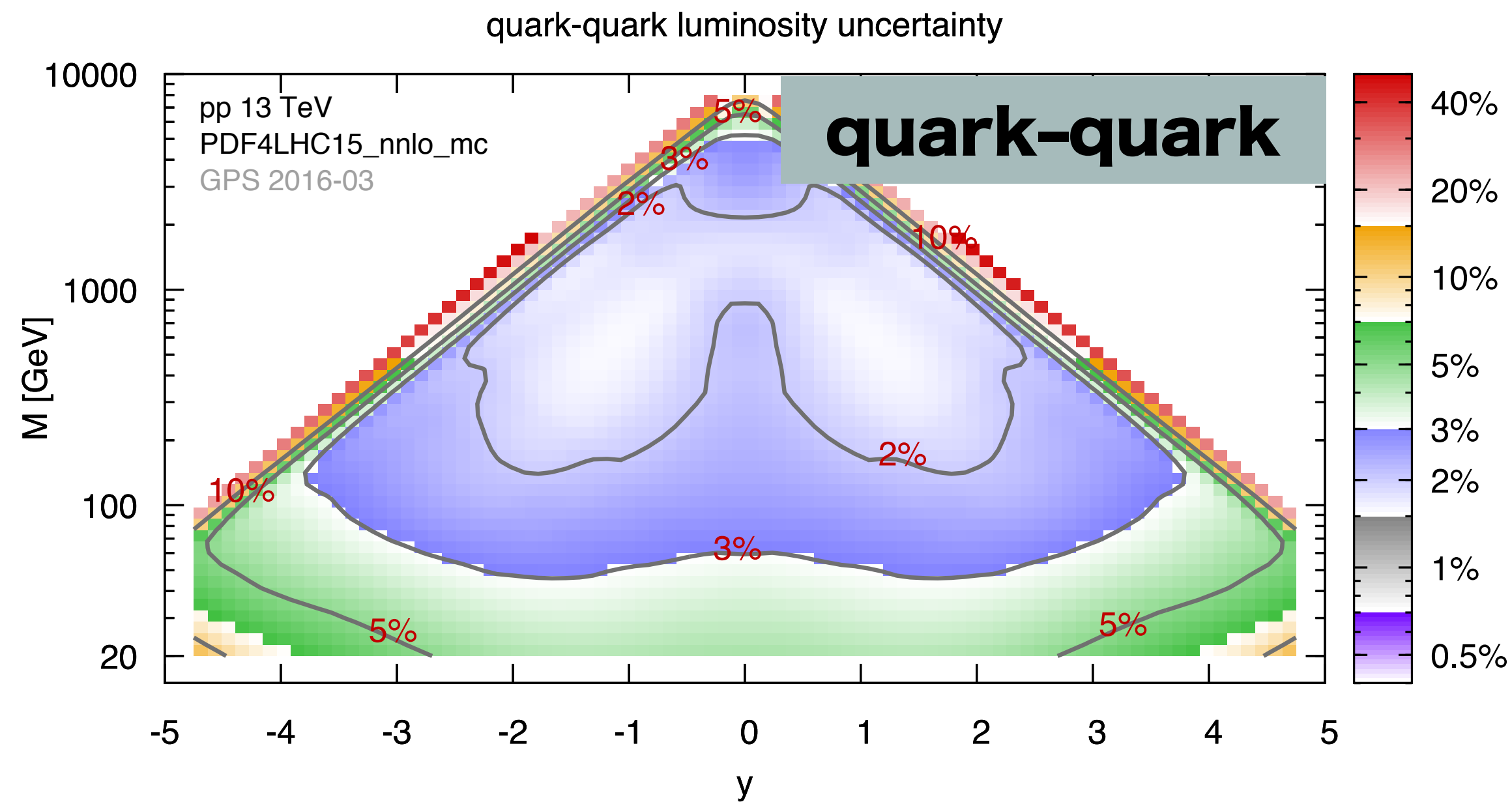
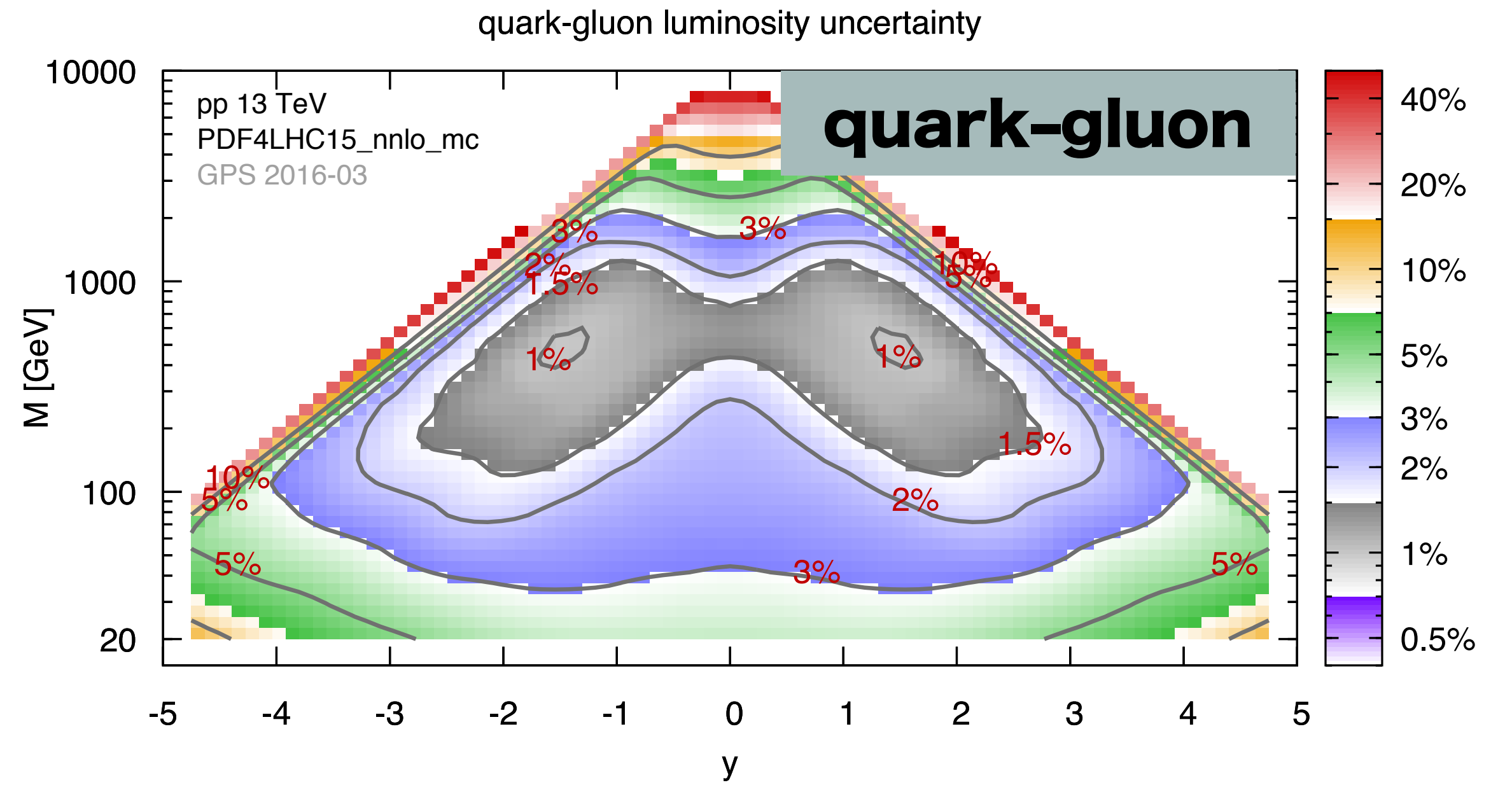
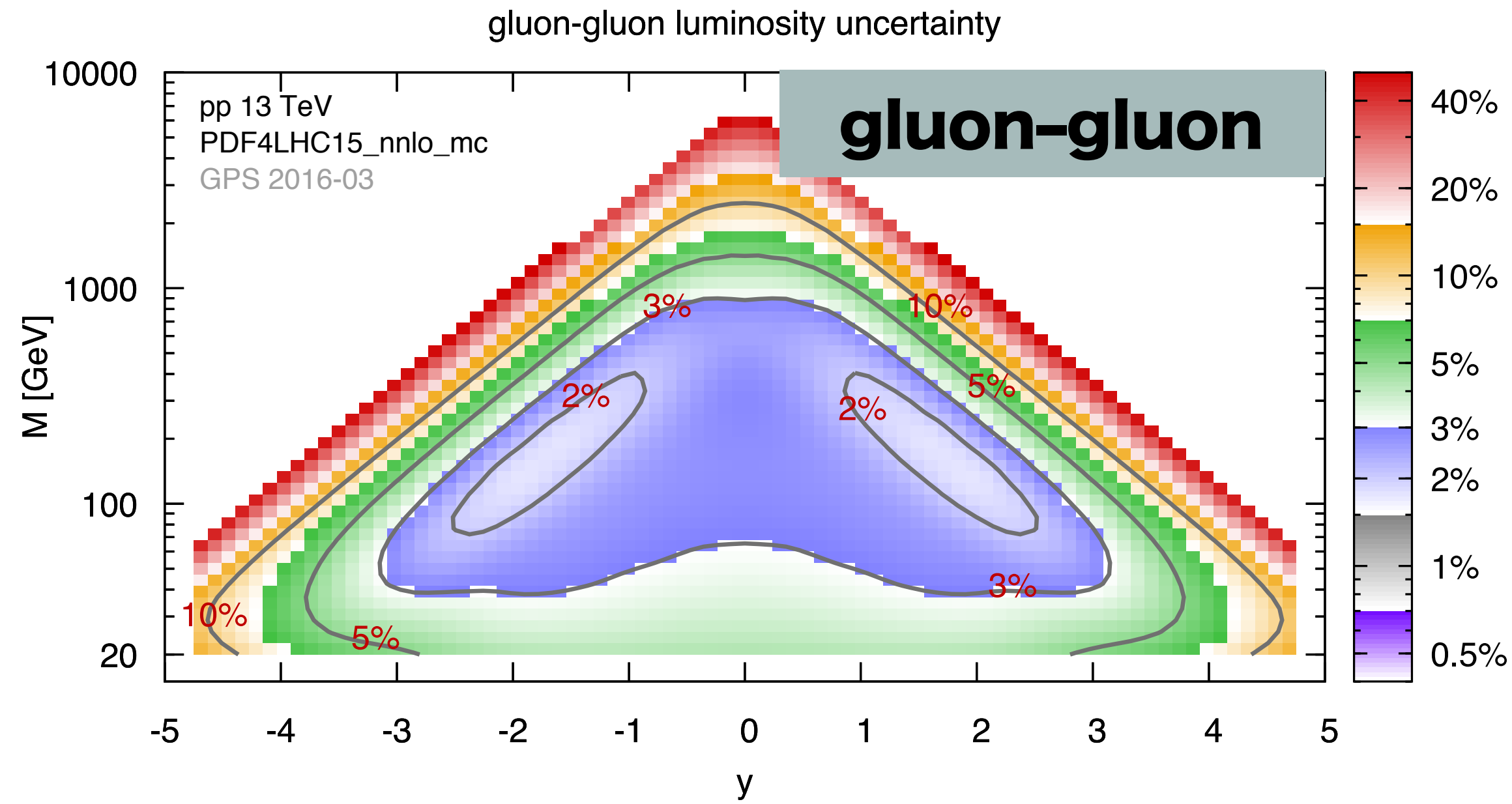

WHAT ROUTE FOR PROGRESS?

- Current status is 2–3% for core “precision” region
- Path to 1% is not clear — e.g. $Z p_T$'s strongest constraint is on qg lumi, which is already best known (why?)
- It'll be interesting to revisit the question once $t\bar{t}$, incl. jets, $Z p_T$, etc. have all been incorporated at NNLO
- Can expts. get **better lumi determination?**
- [is it time for PDFs to include theory uncertainties?]

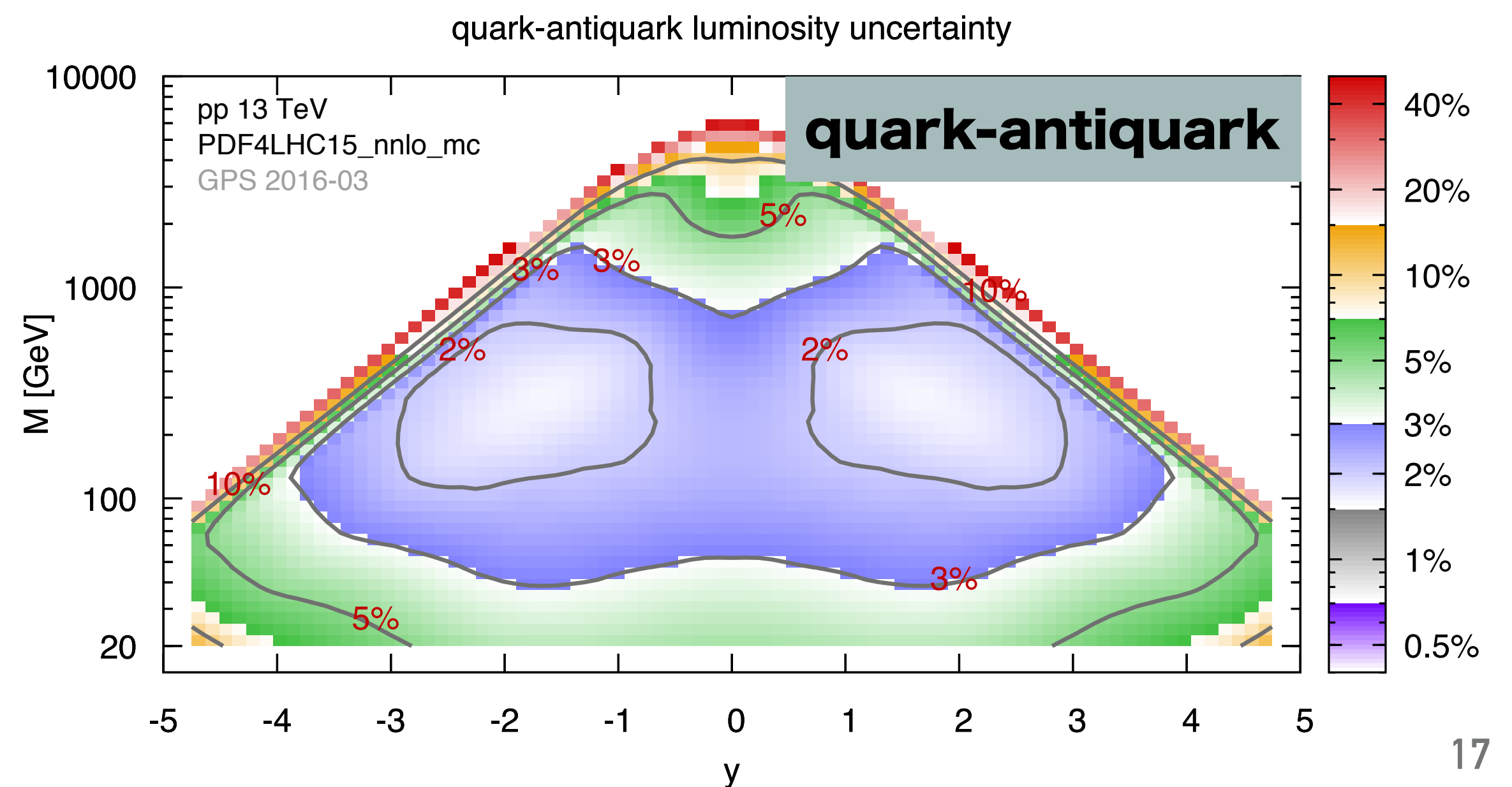
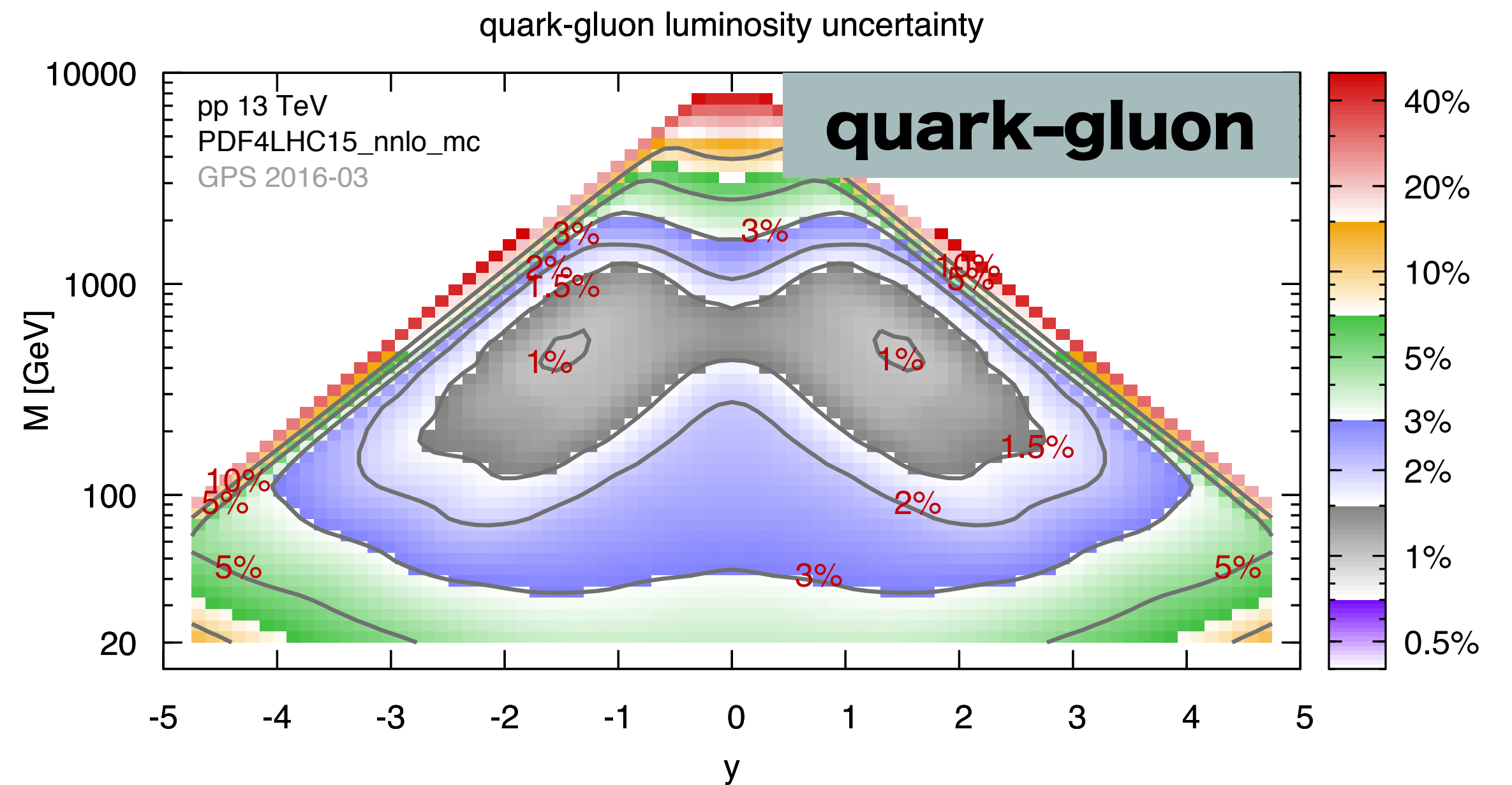

Z P_T : the “ideal” hard process?

One obvious thing to talk about is N3LO Higgs

But in terms of precision, both for data and theory, Z p_T is a more immediate testing ground for 1% effects.

(& unlike Z & W prodⁿ it's sensitive to a_s)

Z p_T : uncertainties somewhat smaller for ATLAS than CMS

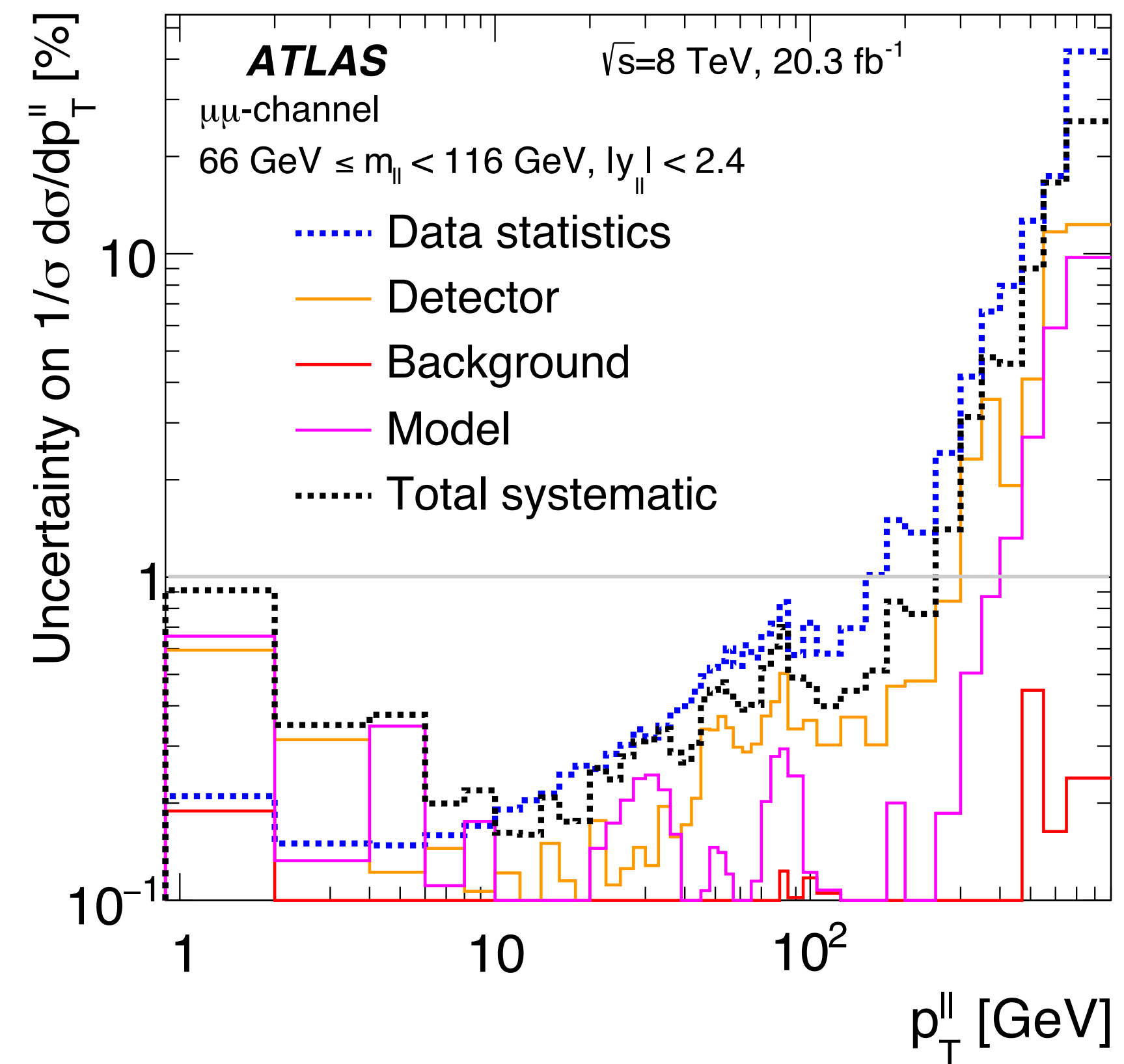
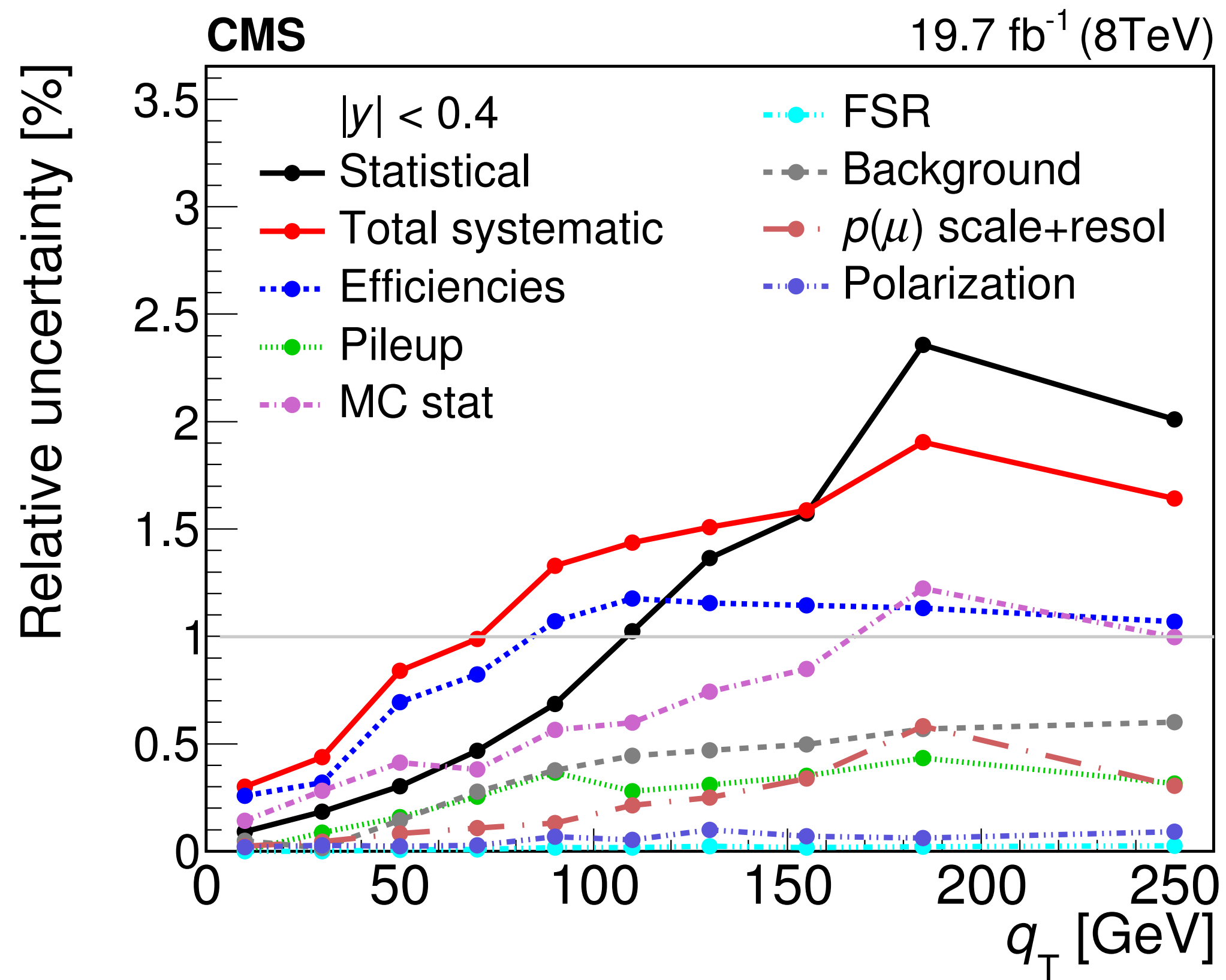

Z p_T : Data v. two (preliminary) theory calculations

$p p \rightarrow Z + \geq 0 \text{ jet} \quad (p_T^Z > 20 \text{ GeV})$

NLO — NNLO — Data —●—

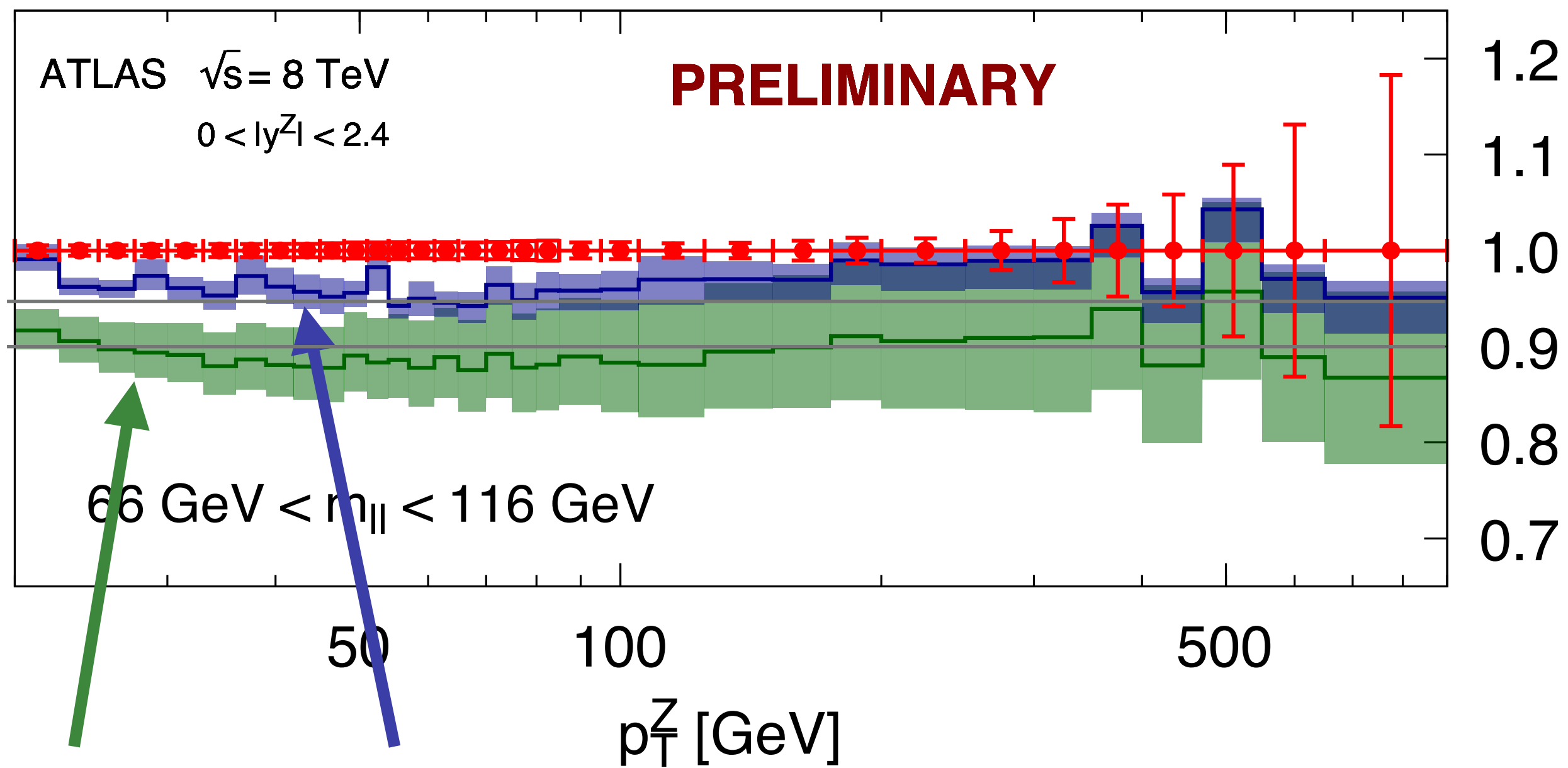

NLO

NNLO

Alexander Huss

in collaboration with
A. Gehrmann-De Ridder, T. Gehrmann,
E.W.N. Glover and T.A. Morgan

8 TeV ATLAS Z

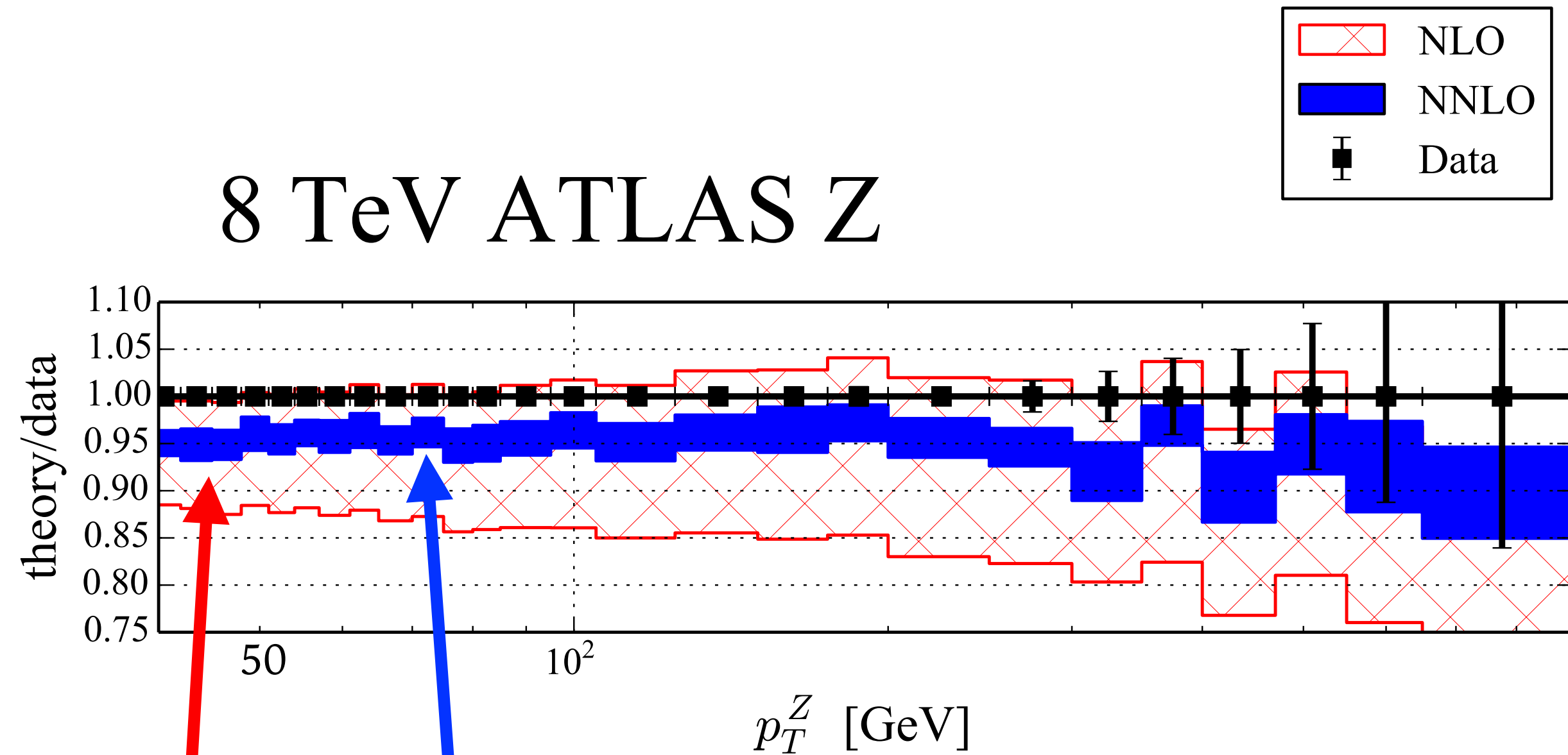

NLO

NNLO

*Boughezal, Liu & Petriello
'16 preliminary
(including EW corr.)*

NNLO ~ ±1.5 %

REMARKS

- Looks like scale uncertainties are $\pm 1\text{--}2\%$ (but how well does series converge?)
- In key 50–100 GeV region, data seem $\sim 4\%$ higher than NNLO theory
- This could have important implications for α_s and PDFs (smaller α_s will not help!)
- **What about non-perturbative effects?**

NB: both calc^n use a central scale

$$\mu = \sqrt{m_Z^2 + p_{T,Z}^2}$$

An alternative

$$\mu = \frac{1}{2} \left(p_{T,Z} + \sqrt{m_Z^2 + p_{T,Z}^2} \right)$$

would seem more consistent with choices being made elsewhere (and might show better convergence)

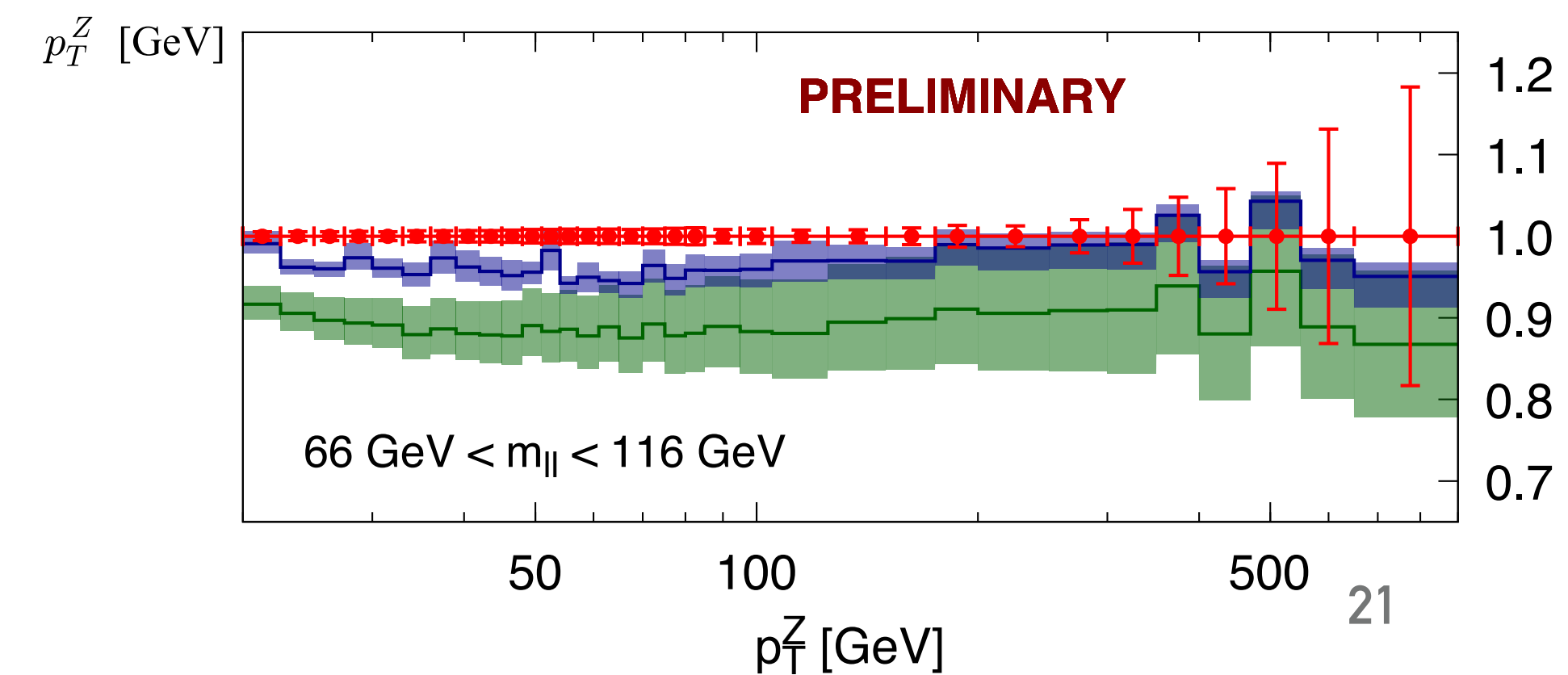
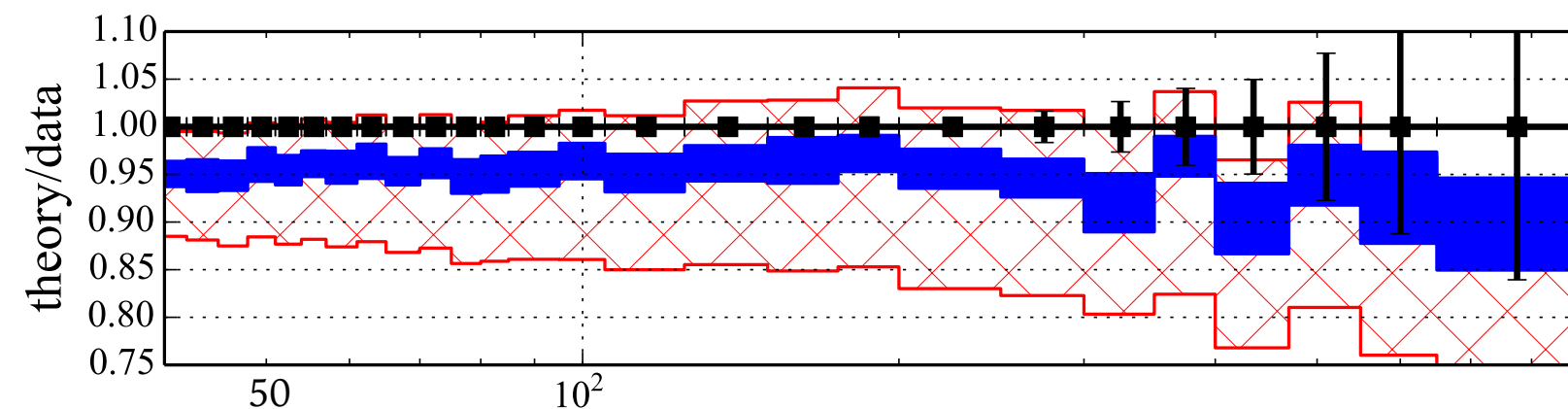

Non-perturbative effects in Z p_T

- Inclusive Z cross section should have $\sim \Lambda^2/M^2$ corrections ($\sim 10^{-4}$?)
- Z p_T is **not inclusive** so corrections can be $\sim \Lambda/M$.
- It seems size of effect can't be probed by turning MC hadronisation on/off [maybe by modifying underlying MC parameters?]

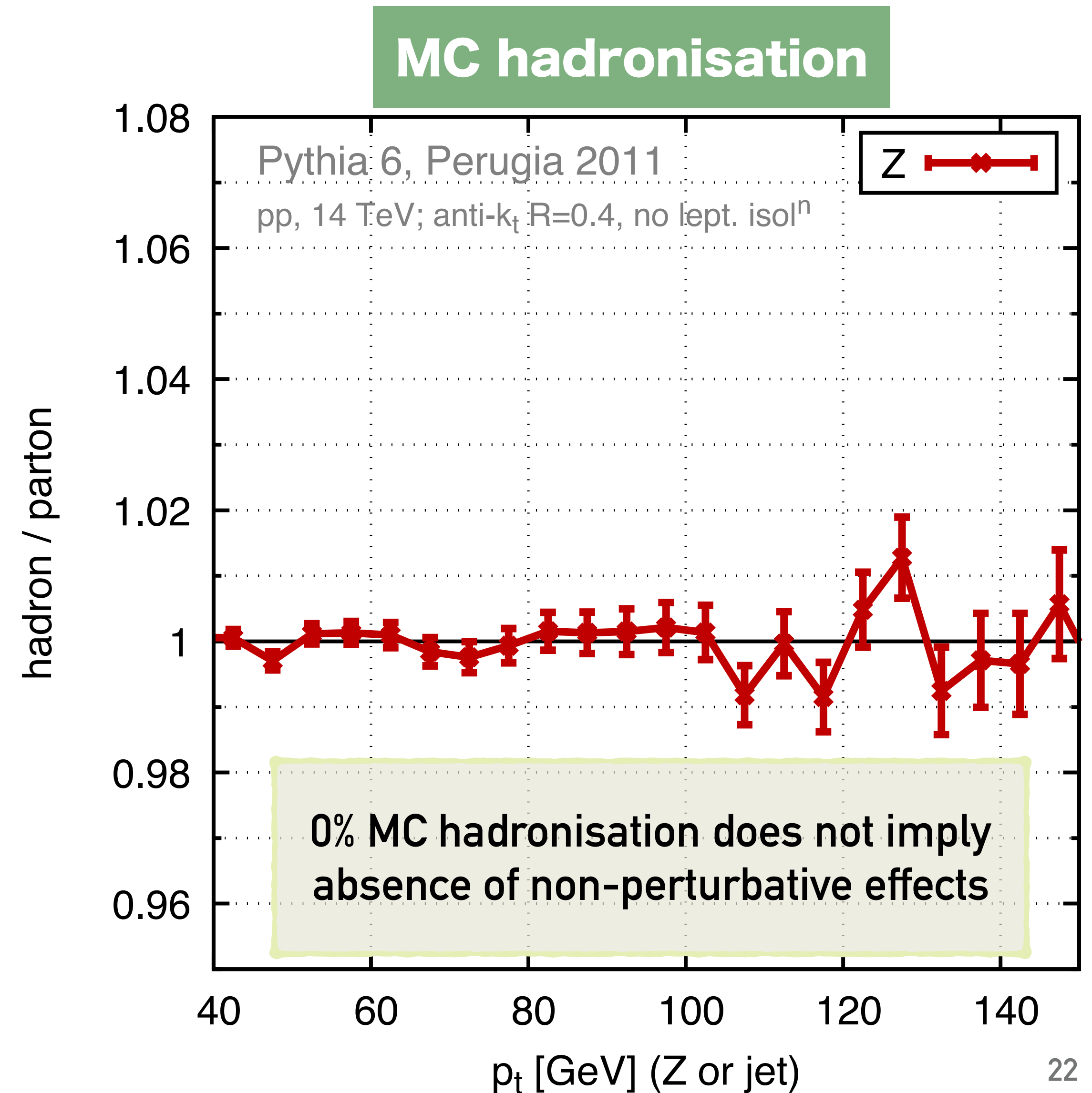

Non-perturbative effects in Z p_T

- Inclusive Z cross section should have $\sim \Lambda^2/M^2$ corrections ($\sim 10^{-4}$?)
- Z p_T is **not inclusive** so corrections can be $\sim \Lambda/M$.
- Size of effect can't be probed by turning MC hadronisation on/off
[maybe by modifying underlying MC parameters?]
- Shifting Z p_T by a finite amount illustrates what could happen

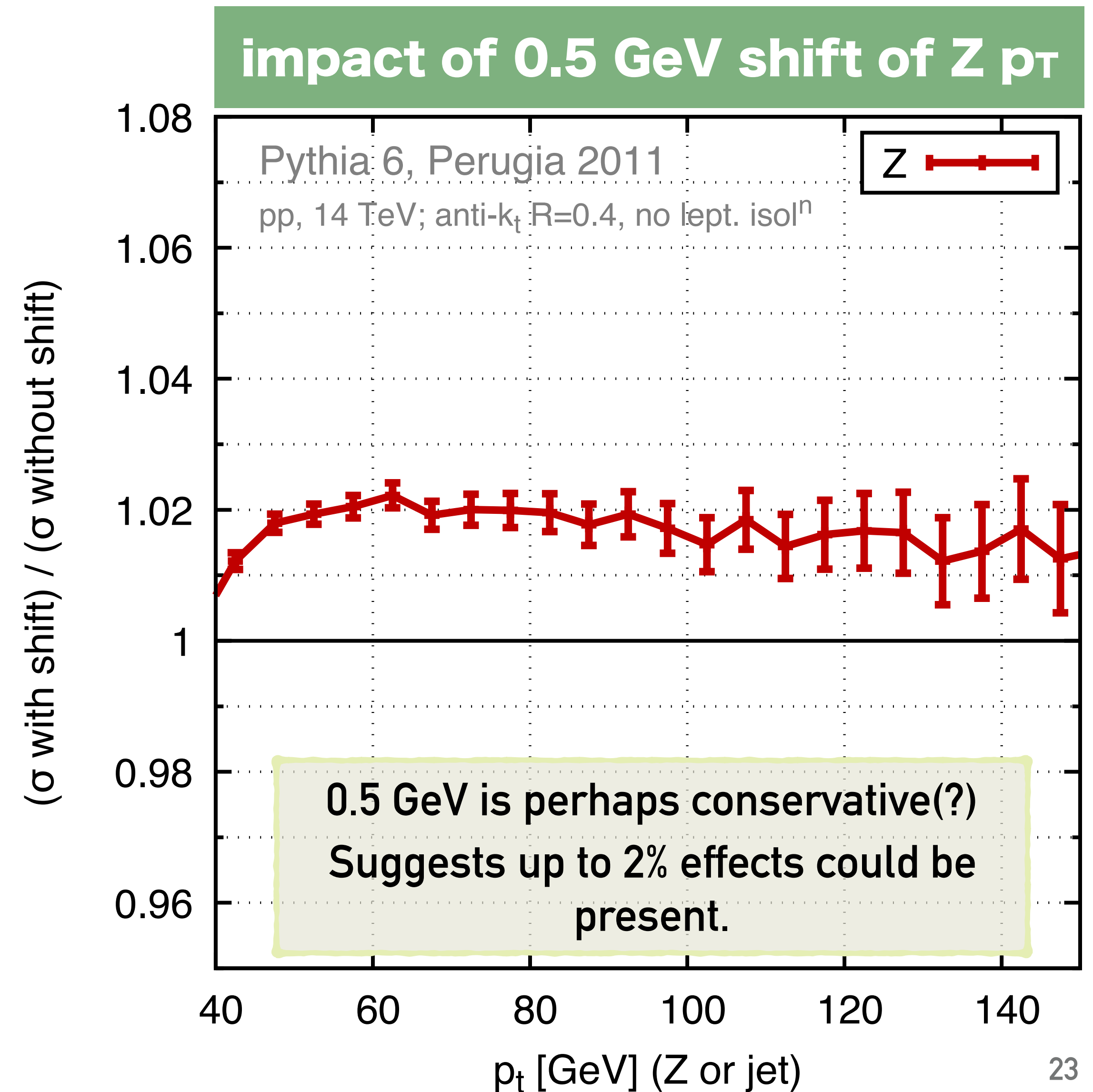

Multi-Parton Interactions?

- Naively, you'd expect these are not correlated with $Z p_T$ — but in at least one MC (Pythia 6) switching them on/off changes distribution by $O(1\%)$

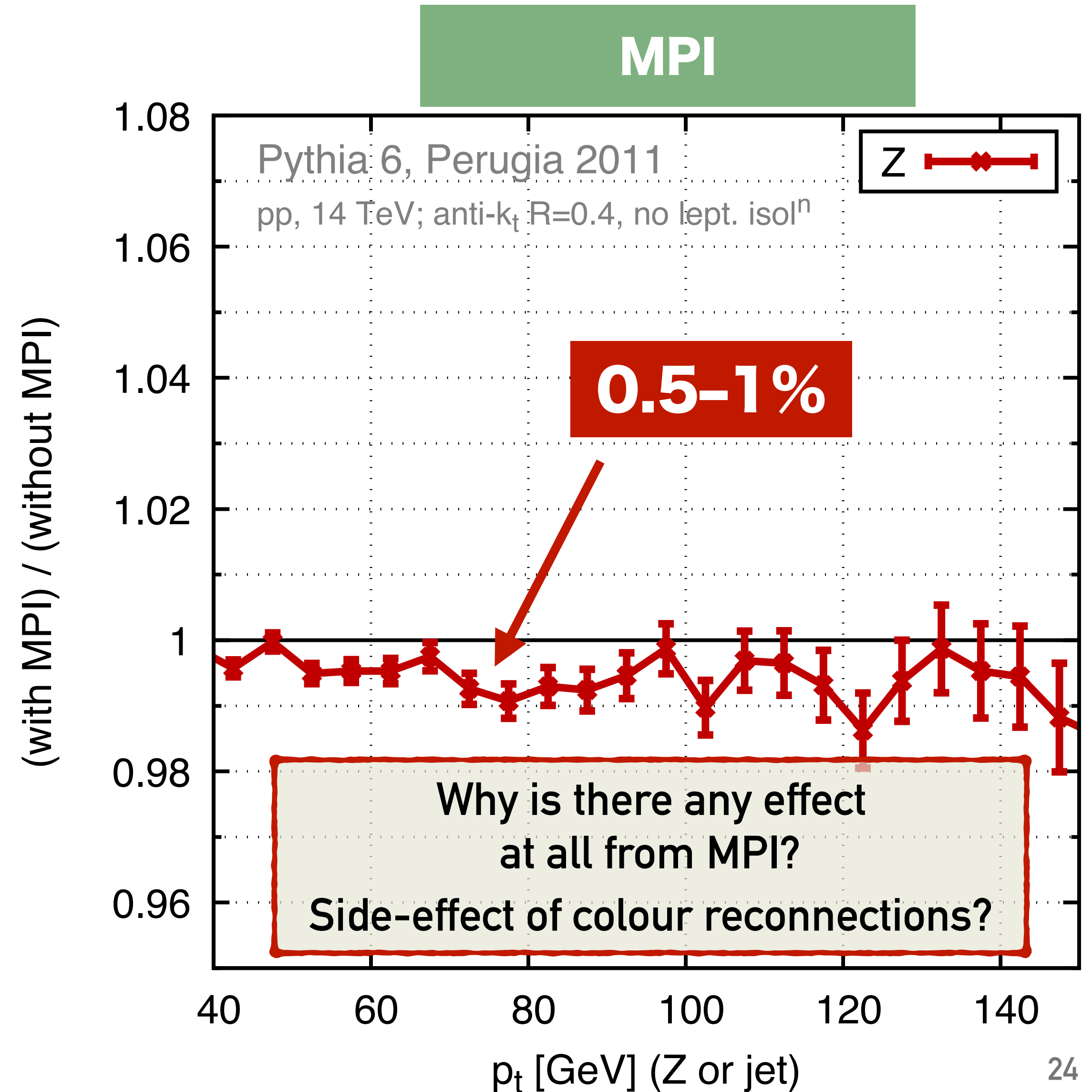

PROCESSES WITH (MEASURED) JETS

much less inclusive wrt QCD radiation

subject to larger hadronisation effects

THE JET IN Z+JET @ NNLO

Boughezal, Liu & Petriello, 1602.08140

1-jet cross sections

	σ_{LO} (pb)	σ_{NLO} (pb)	σ_{NNLO} (pb)	K_{NLO}	K_{NNLO}
8 TeV	$4.17^{+0.55}_{-0.47}$	$6.59^{+0.62}_{-0.53}$	$6.86^{+0.01}_{-0.13}$	1.58	1.04
13 TeV	$9.12^{+0.88}_{-0.79}$	$14.90^{+1.29}_{-1.06}$	$15.54^{+0.01}_{-0.24}$	1.63	1.04

- NNLO K-factor is 4%
- Residual scale uncertainty < 2%

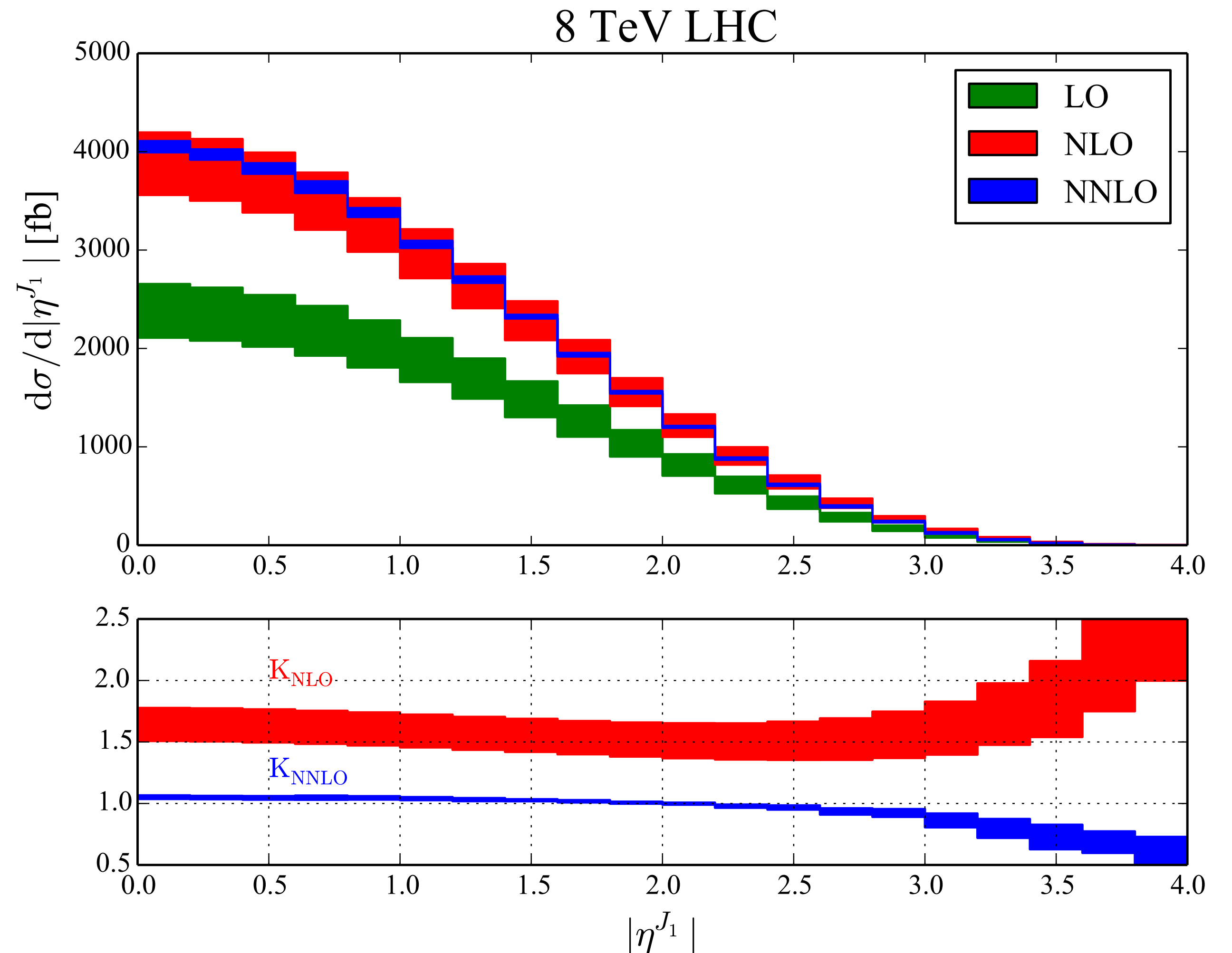

HIGGS JET VETO @ N3LO + NNLL

Anastasiou, Duhr, Dulat, Herzog & Mistlberger 1503.06056

Boughezal, Caola, Melnikov, Petriello & Schulze 1504.07922

*Banfi, Caola, Dreyer, Monni, GPS, Zanderighi & Dulat
1511.02886*

- N3LO effects at 2–4%
- **Residual uncertainty up to 4%** (fairly conservative estimate)

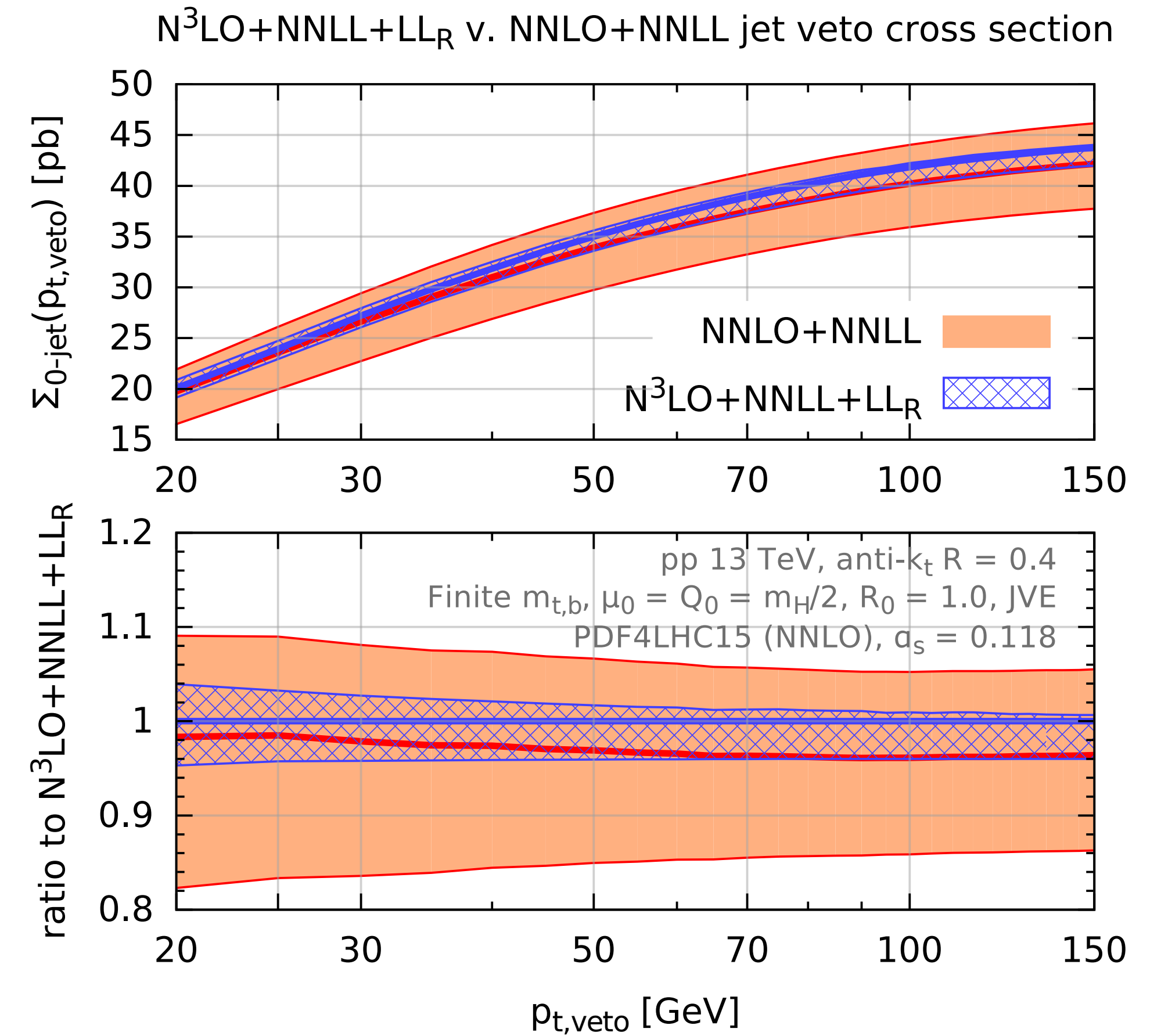

HIGGS JET VETO @ N3LO + NNLL

Anastasiou, Duhr, Dulat, Herzog & Mistlberger 1503.06056

Boughezal, Caola, Melnikov, Petriello & Schulze 1504.07922

*Banfi, Caola, Dreyer, Monni, GPS, Zanderighi & Dulat
1511.02886*

- N3LO effects at 2–4%
- Residual uncertainty up to 4% (fairly conservative)
- rather stable ($\sim 2\%$) wrt jet- p_T resummation effects

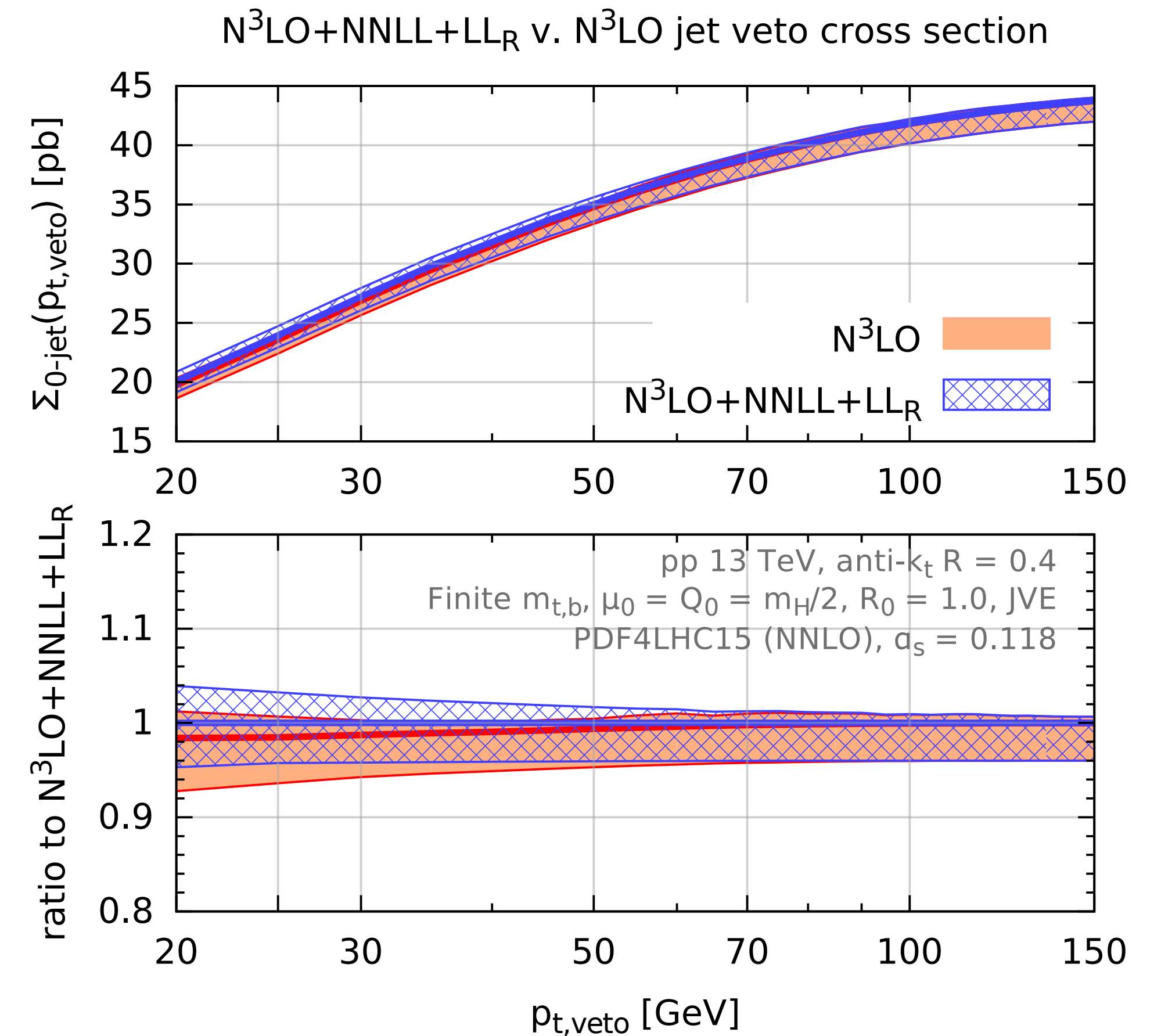

2 KINDS OF EFFECT IN SUCH PROCESSES ?

- “Inclusive” correction to process as a whole (insofar as this is meaningful)
- corrections related to jet fragmentation

Can we make such a distinction more meaningful?

VECTOR-BOSON FUSION → HIGGS

- ▶ double DIS approximation is powerful tool for VBF, using structure functions for the W/Z production (Han, Valencia & Willenbrock 1992, NNLO by Bolzoni et al 1003.4451)

- ▶ Now being extended to N3LO, shows scale uncertainties $\ll 1\%$ for observables inclusive wrt the jets
- ▶ good stability from NNLO to N3LO

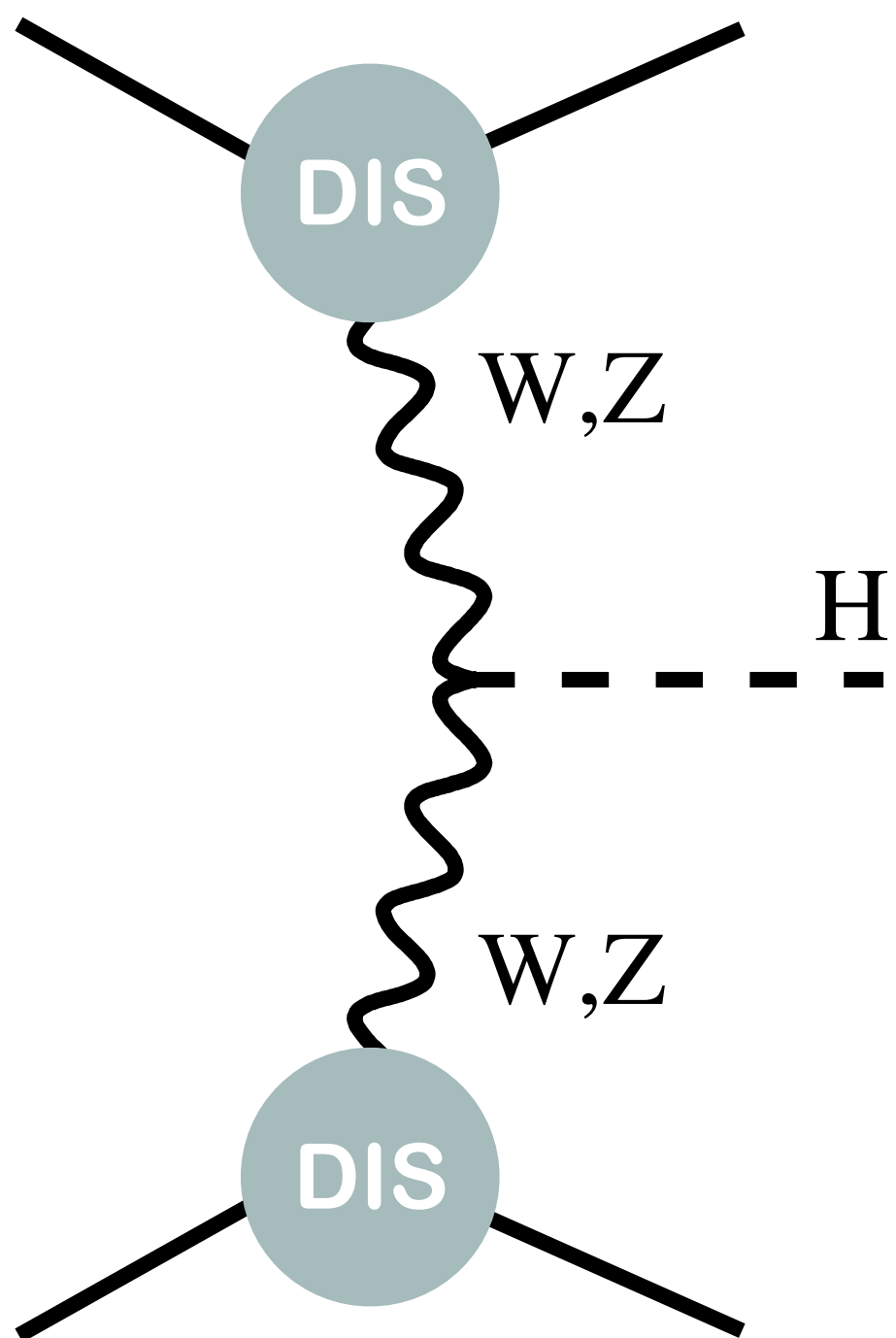

N3LO

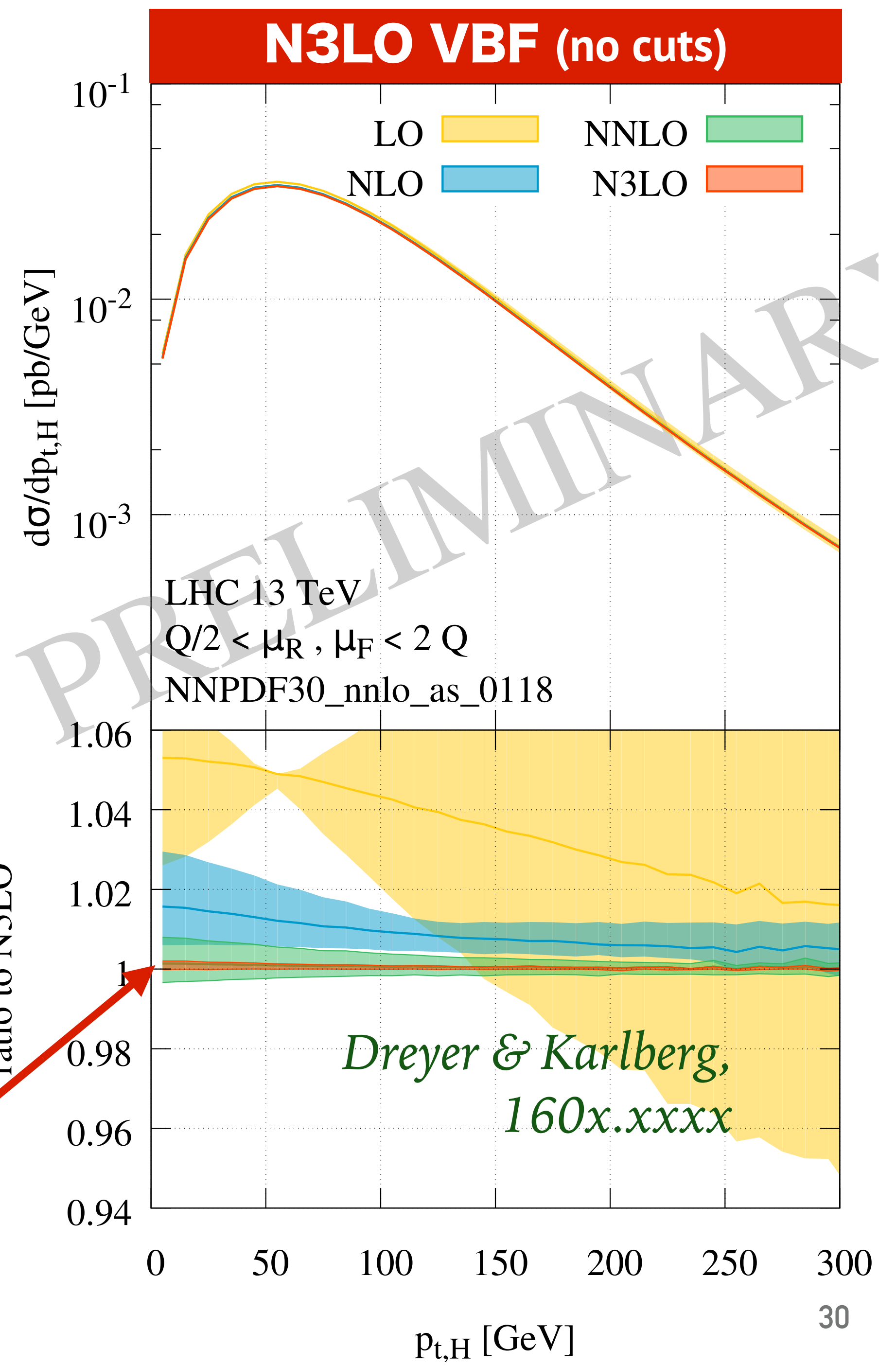

VECTOR-BOSON FUSION → HIGGS

- ▶ double DIS approximation is powerful tool for VBF, using structure functions for the W/Z production (Han, Valencia & Willenbrock 1992, NNLO by Bolzoni et al 1003.4451)

- ▶ Now being extended to N3LO, shows scale uncertainties $\ll 1\%$ for observables inclusive wrt the jets
- ▶ good stability from NNLO to N3LO

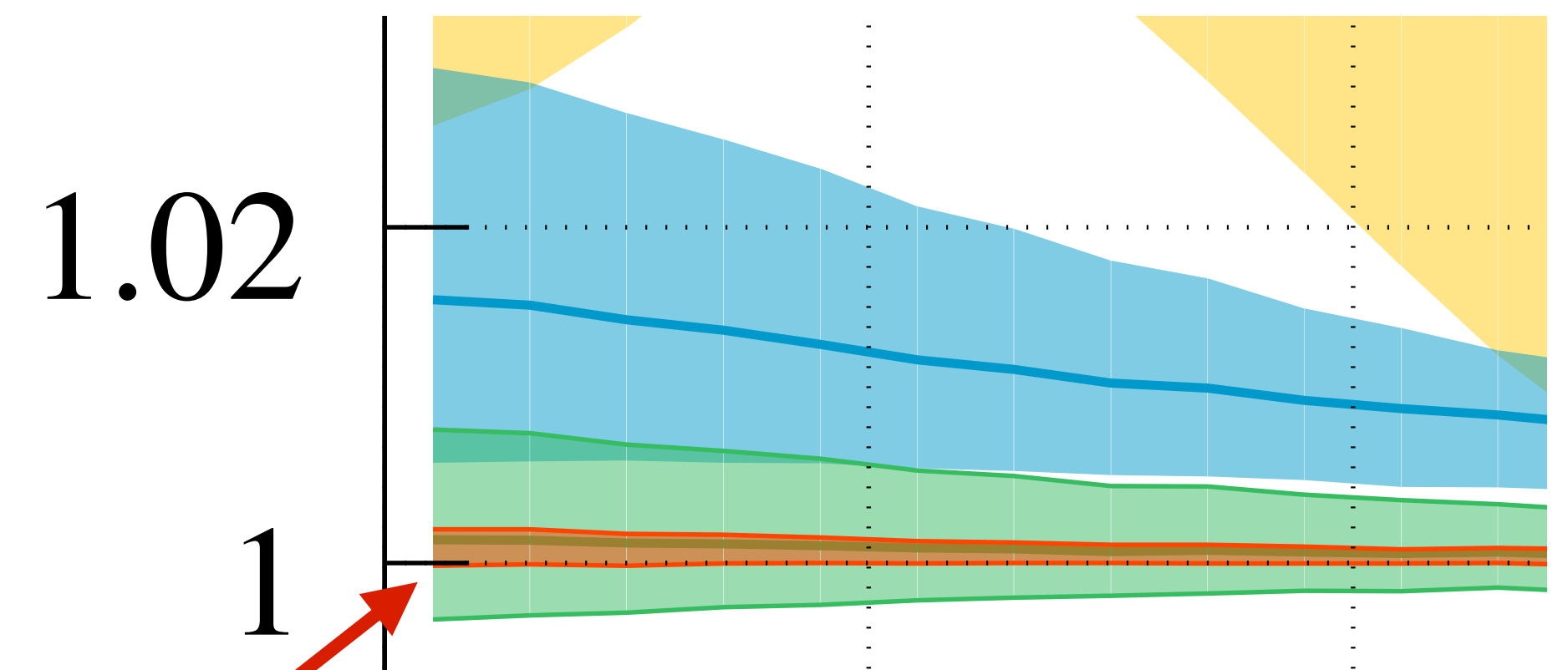
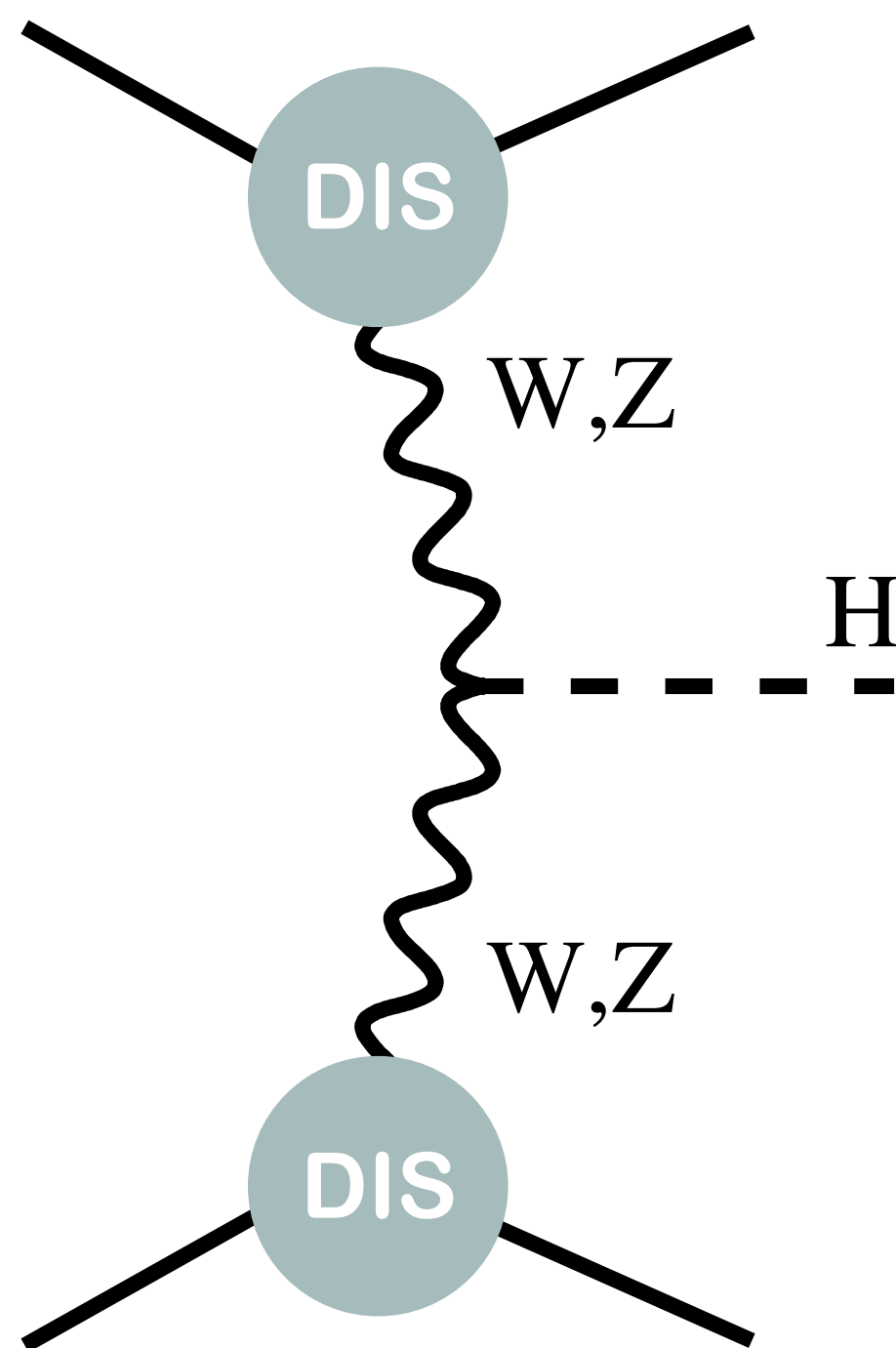

*Dreyer & Karlberg,
160x.xxxx*

N3LO

VBF with cuts on jets: Projection to Born method

Cacciari, Dreyer, Karlberg, GPS & Zanderighi, 1506.02660

(a) Born VBF process

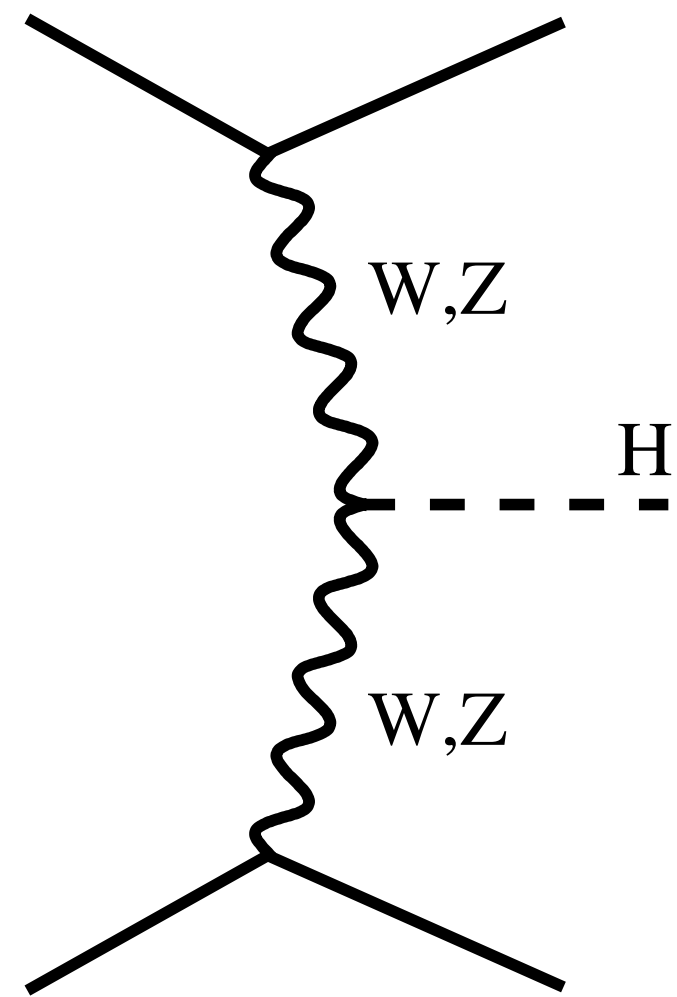

(b) NNLO "inclusive" part (from structure function method)

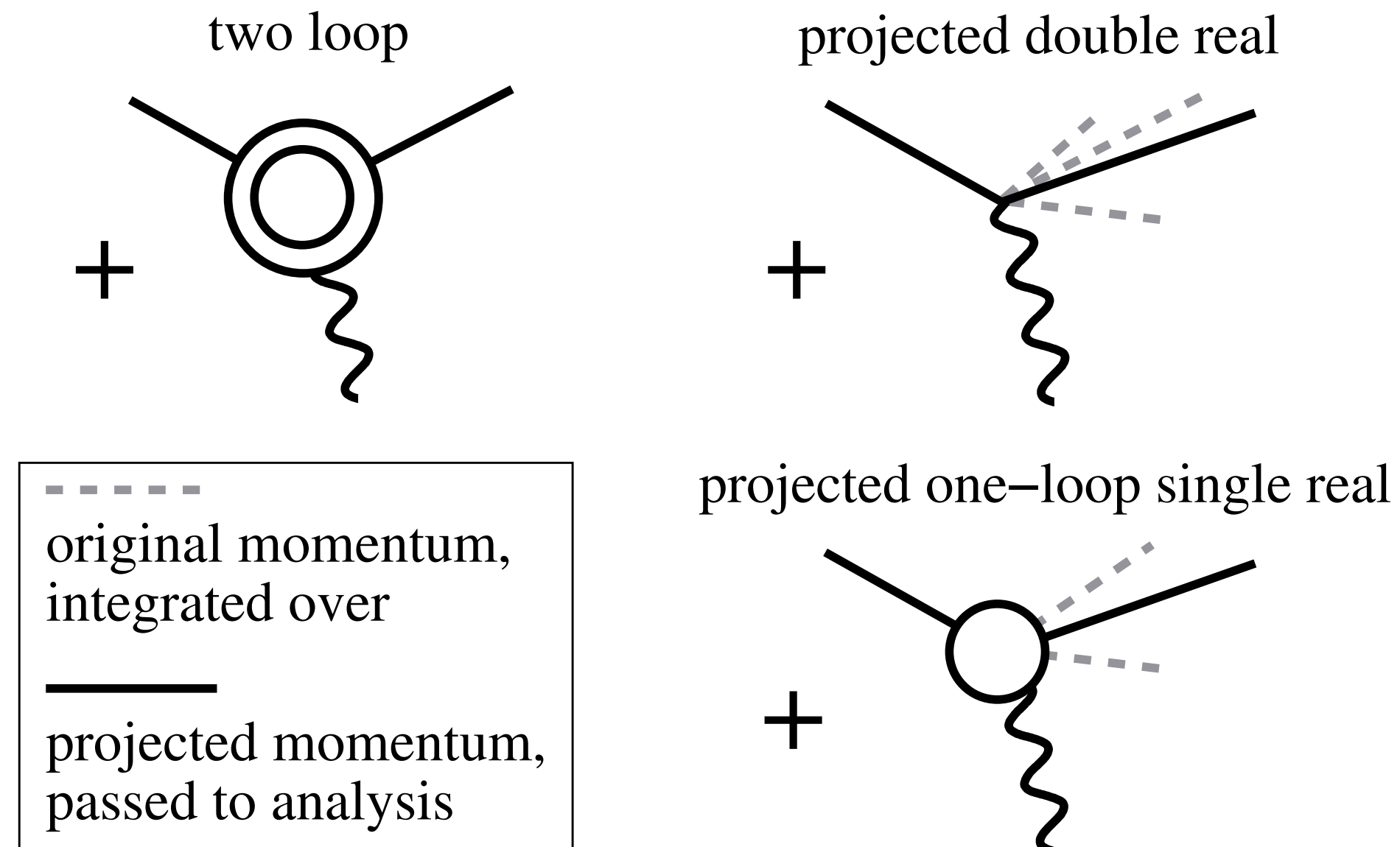

(c) NNLO "exclusive" part (from VBF H+3j@NLO)

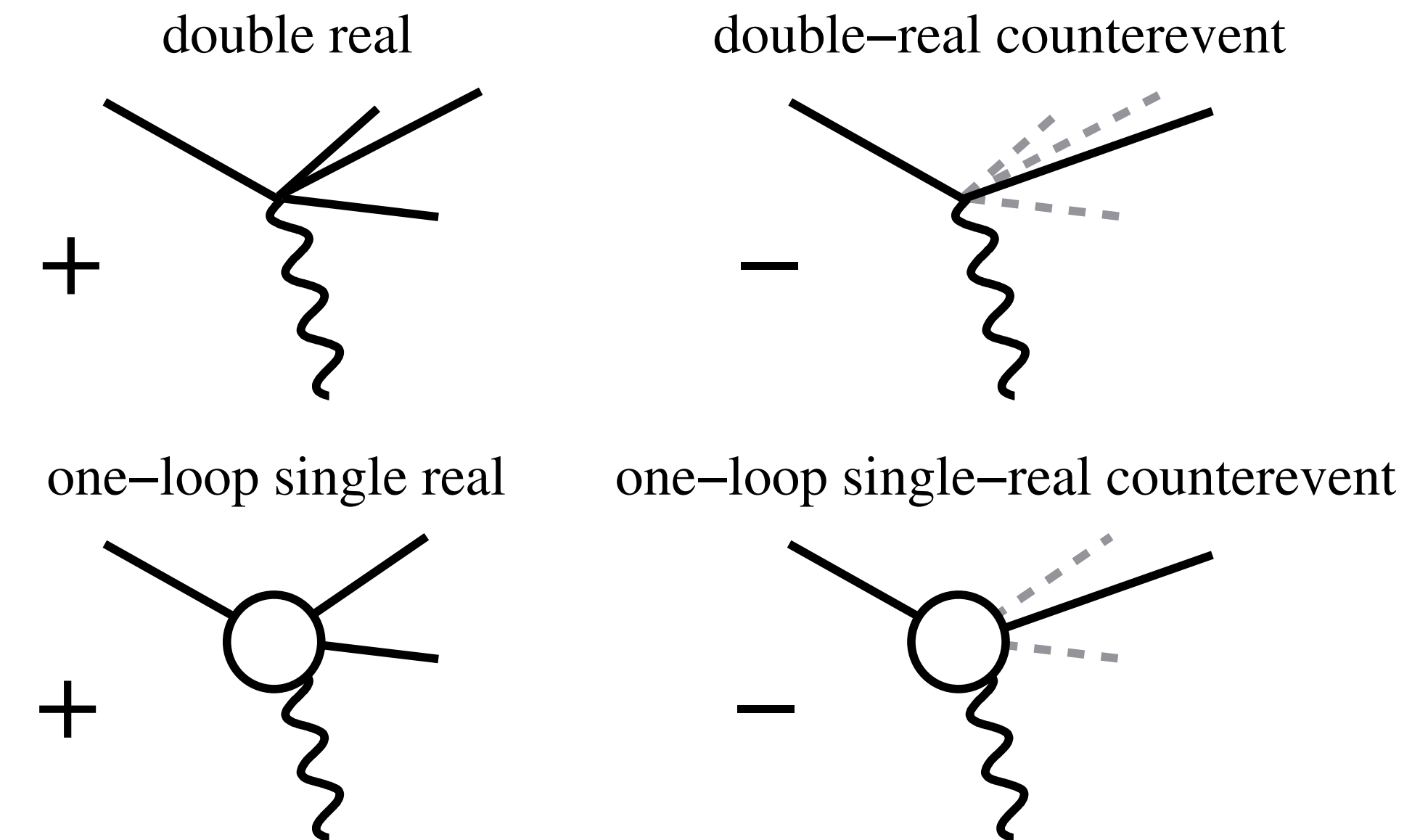

using VBF 3-jet @ NLO from Jäger, Schissler & Zeppenfeld, 1405.6950

Inclusive part only (with VBF cuts)

NNLO is 1% effect

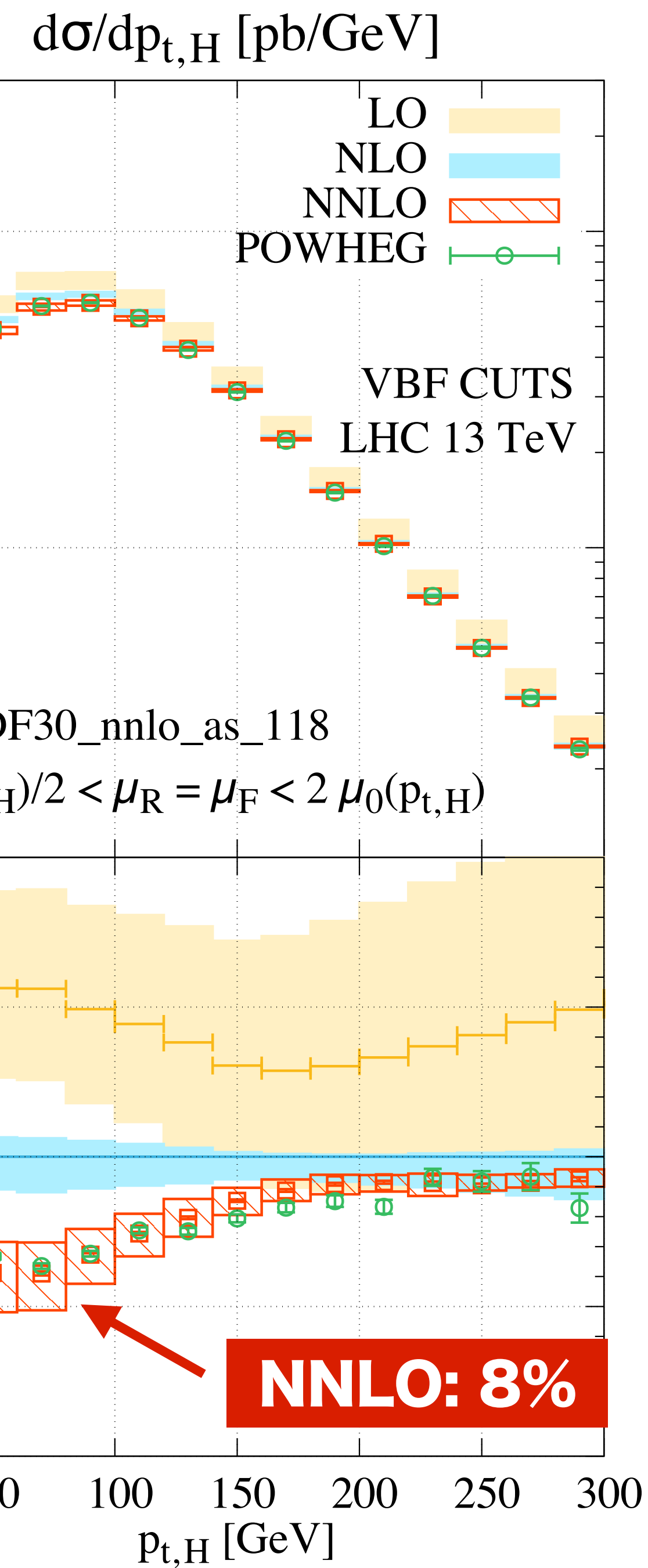
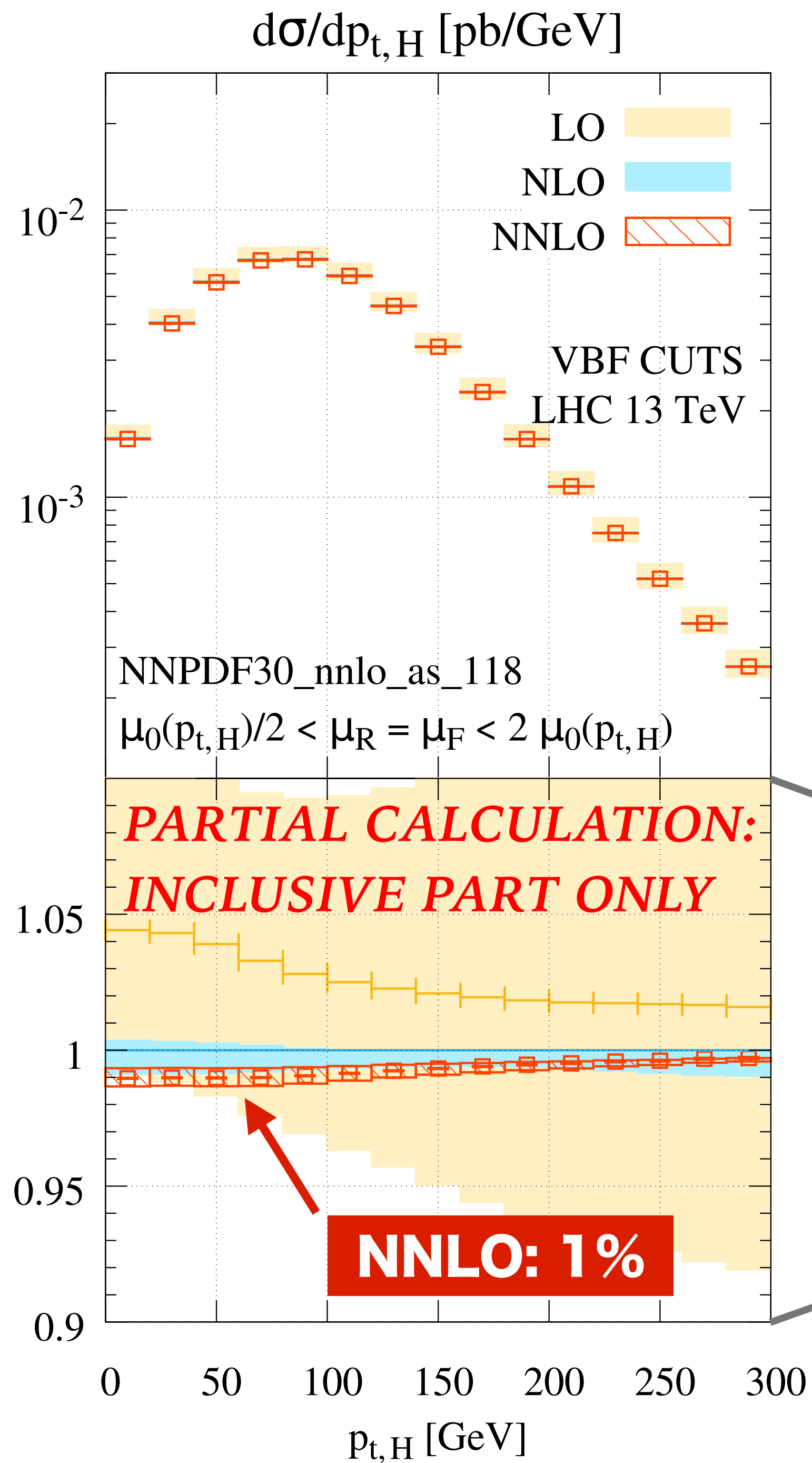

Full calculation (with VBF cuts)

NNLO is up to 8% effect

Almost all of which comes from jet fragmentation

Can we examine same idea in other contexts? **E.g. inclusive jet spectrum**

- There is no way of defining the “inclusive” part in most cases
- But there are arguments that for a jet radius $R_m \simeq 1$, ISR and FSR effects mostly cancel each other [*Soyez, 1006.3634*]
- So try looking at effect of NNLO corrections relative $R_m = 1$ [*can be done with NLO 3-jet calcⁿ from NLOJET++*]

*Dasgupta, Dreyer, GPS
& Soyez, 1602.01110*

$$\sigma^{\text{NNLO}}_R(R, R_m) \equiv \underbrace{\sigma_0 + \sigma_1(R)}_{\text{NLO}} + \underbrace{[\sigma_2(R) - \sigma_2(R_m)]}_{\substack{R\text{-dependent piece of} \\ \text{NNLO, relative to } R_m}}$$

- Full NNLO will have an additional NNLO term associated with the effective K-factor for the “inclusive” piece — we miss that part (and unlike VBF, it may not be small)

NNLO_R & small-R resummation

- to explore full R-range, need resummation as well

$$\sigma(R) = \sigma(R_0 = 1) \times \text{ratio}(R, R_0)_{\text{fixed-order}} + \text{LL}_R$$

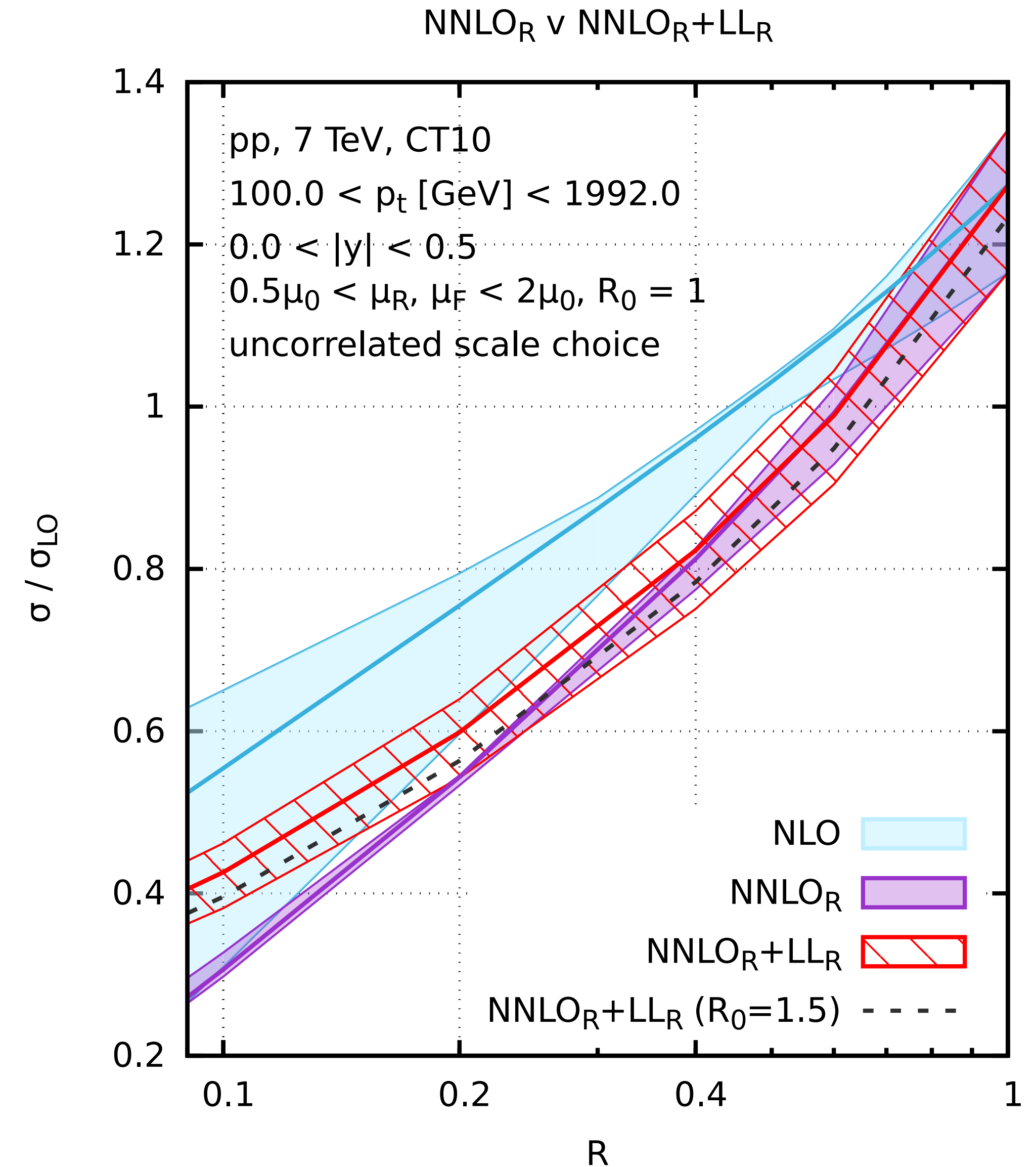

NNLO_R & small-R resummation

- to explore full R-range, need resummation as well

$$\sigma(R) = \sigma(R_0 = 1) \times \text{ratio}(R, R_0)_{\text{fixed-order}} + \text{LL}_R$$

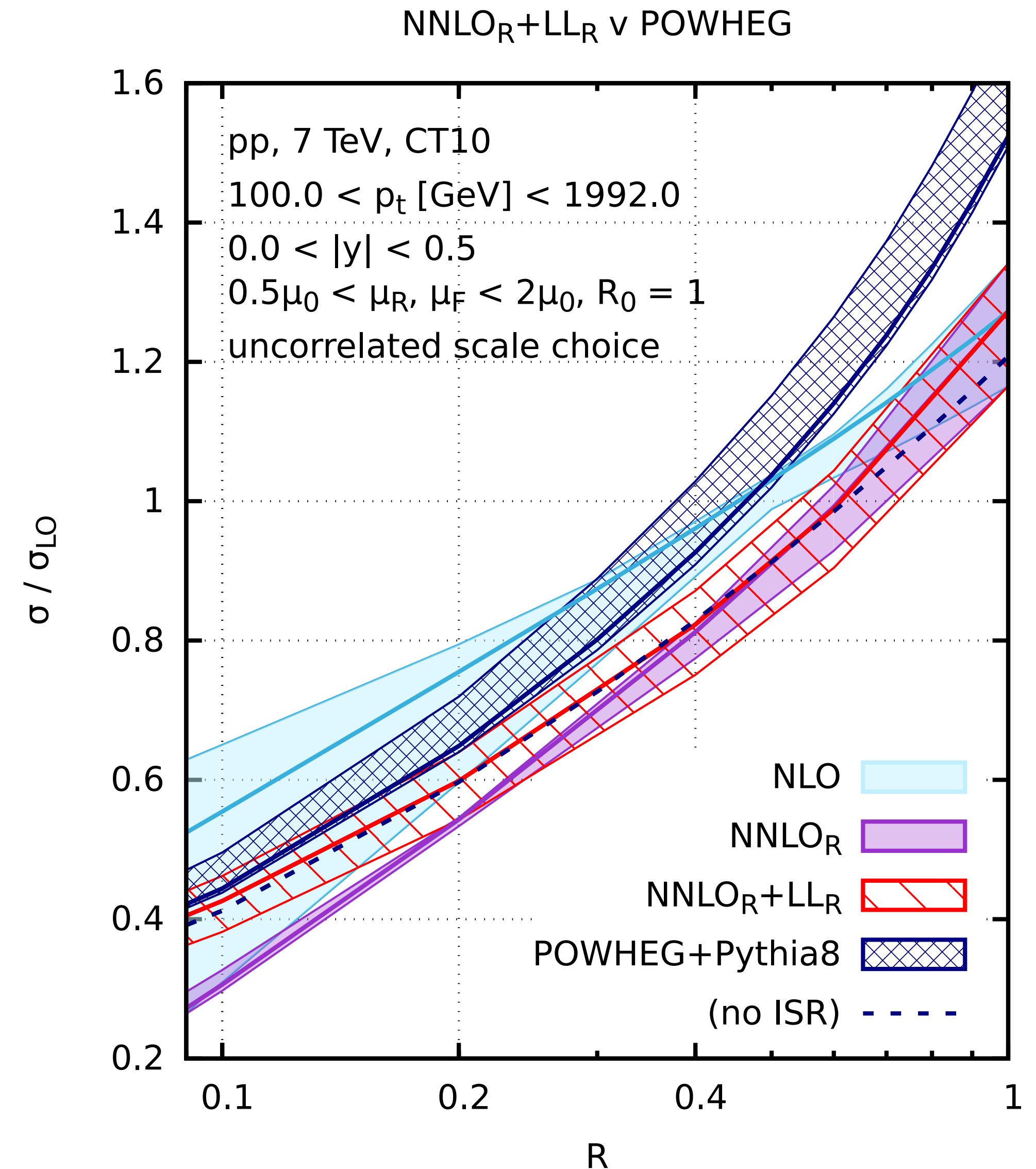

NNLO_R & small-R resummation

- to explore full R-range, need resummation as well

$$\sigma(R) = \sigma(R_0 = 1) \times \text{ratio}(R, R_0)_{\text{fixed-order}} + \text{LL}_R$$

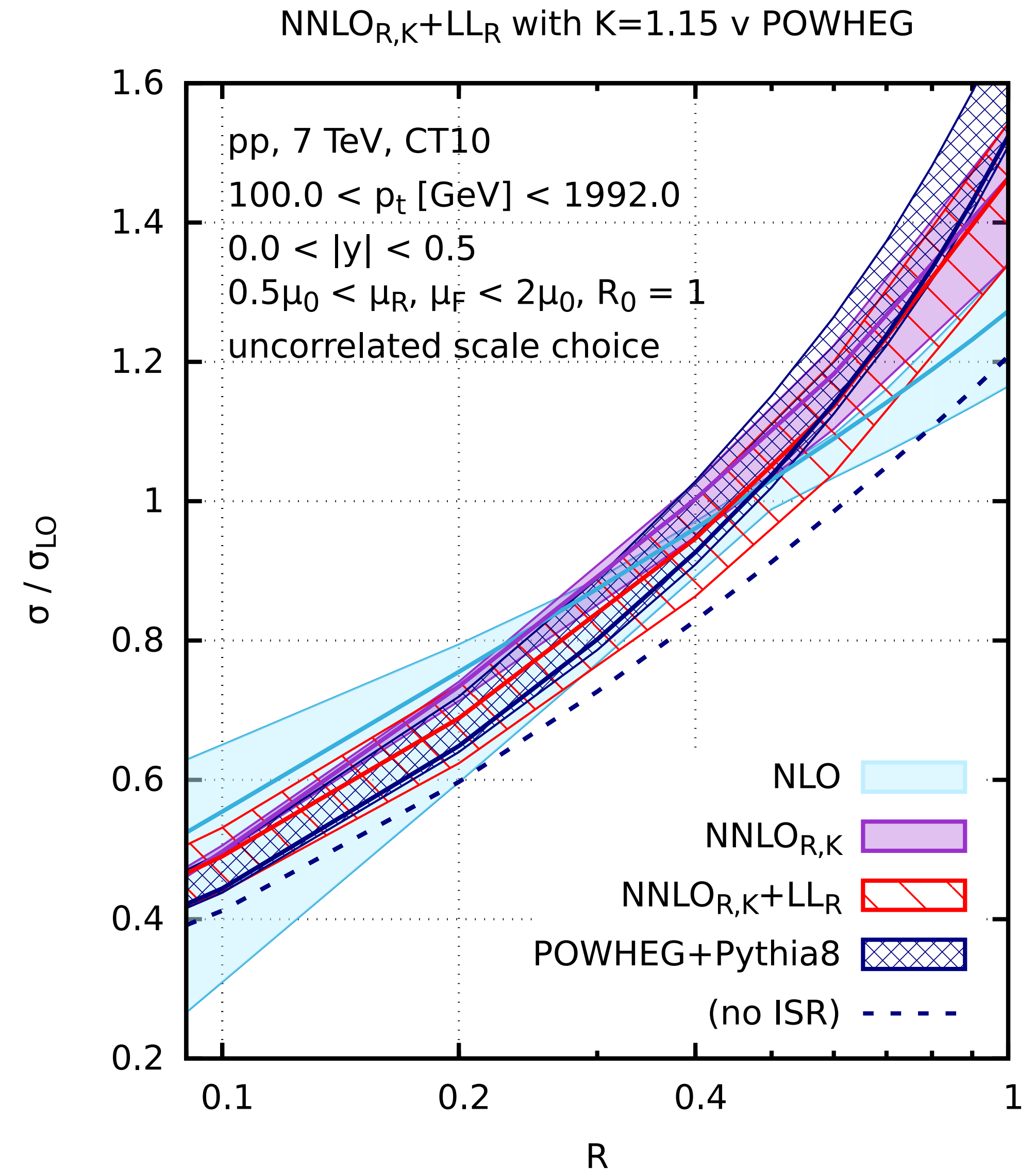

NON-PERTURBATIVE EFFECTS & JETS

Often discussed for inclusive jet spectrum
But relevant for any process involving jets

Jet v. Z in Z+jet process

impact of hadronisation

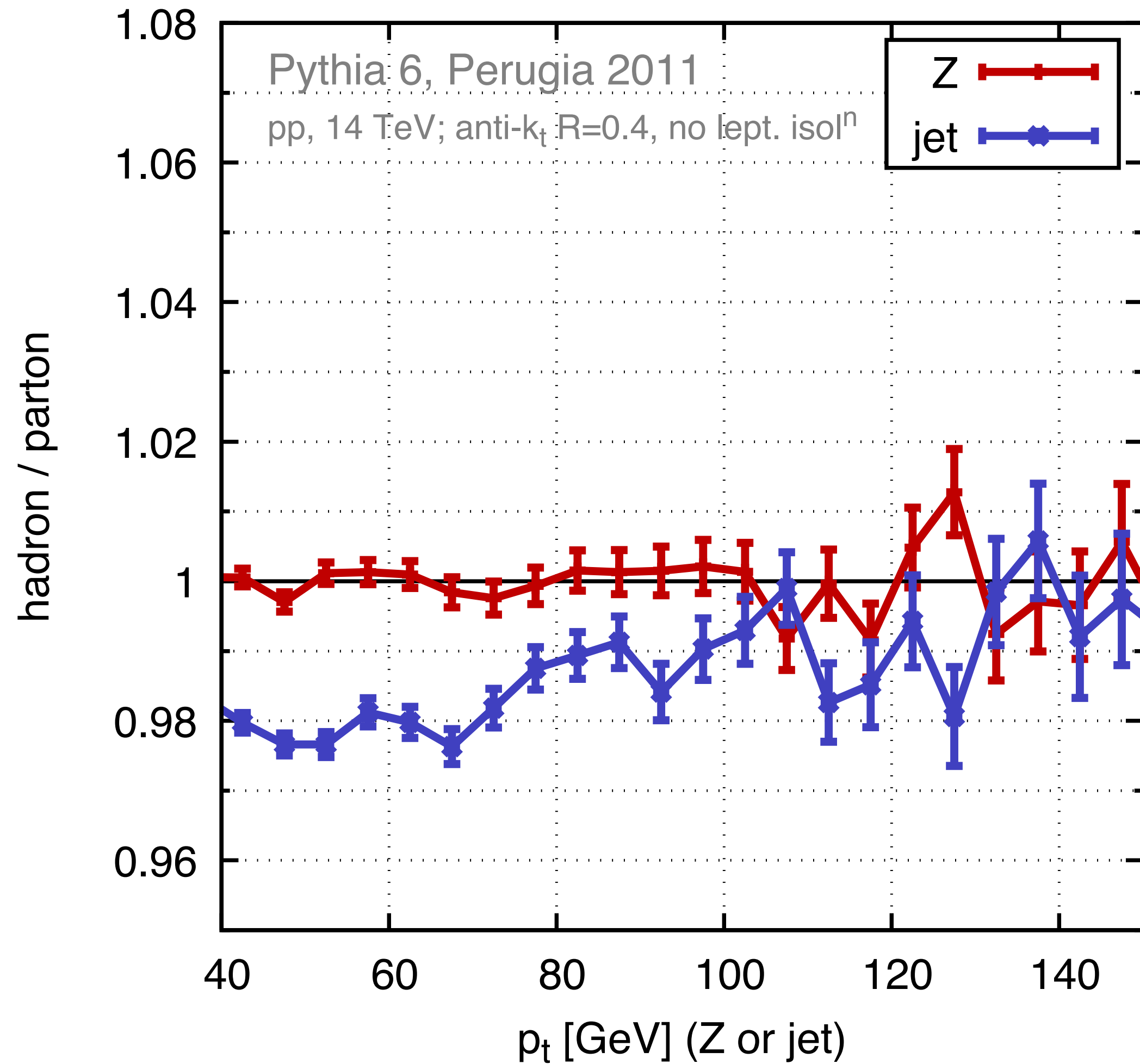

impact of MPI (UE)

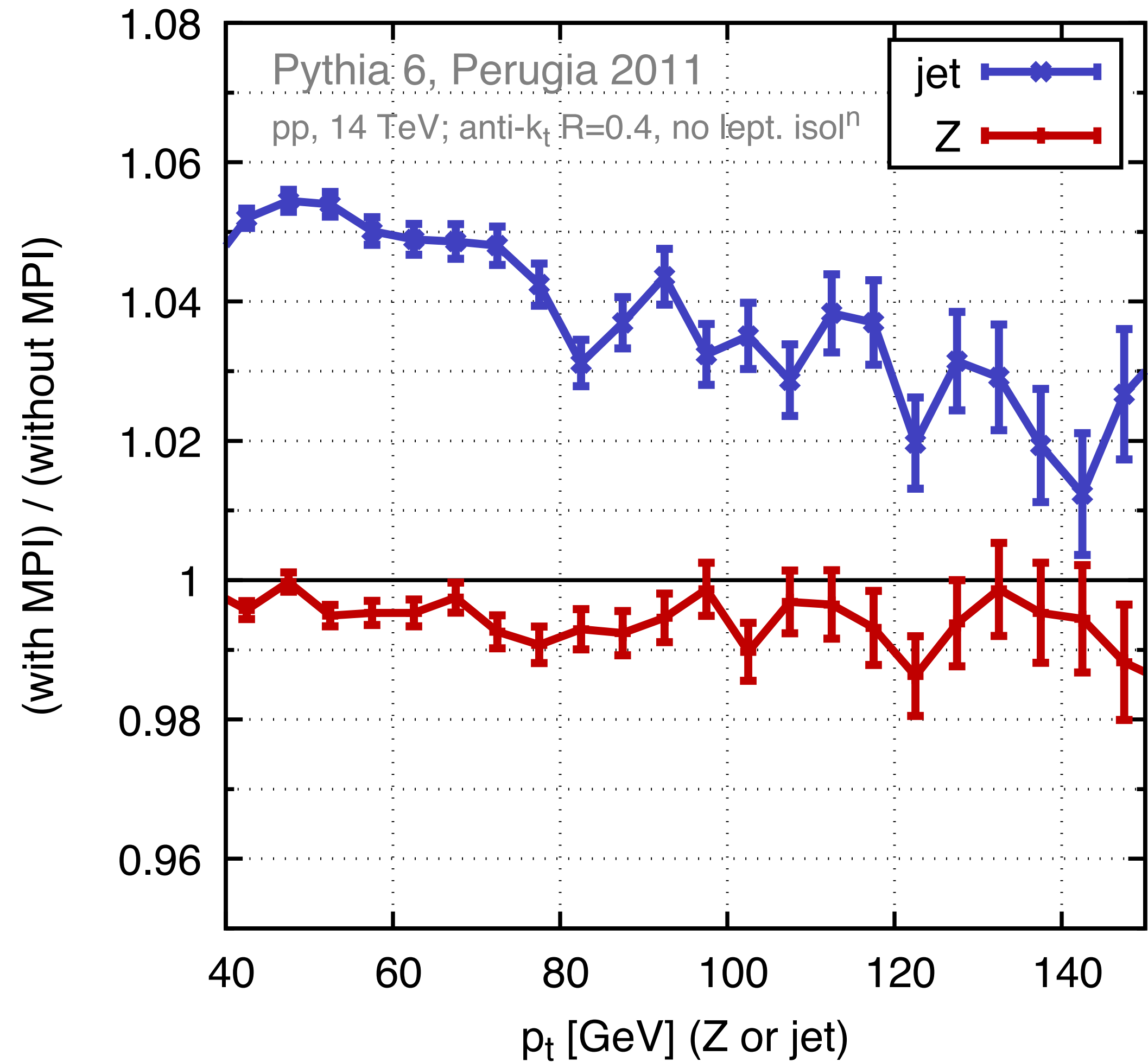

2 - 5% effects for jets

Higgs jet veto

1 - 3% effects for jets

Higgs production ($m_H = 125$ GeV), impact of hadronisation

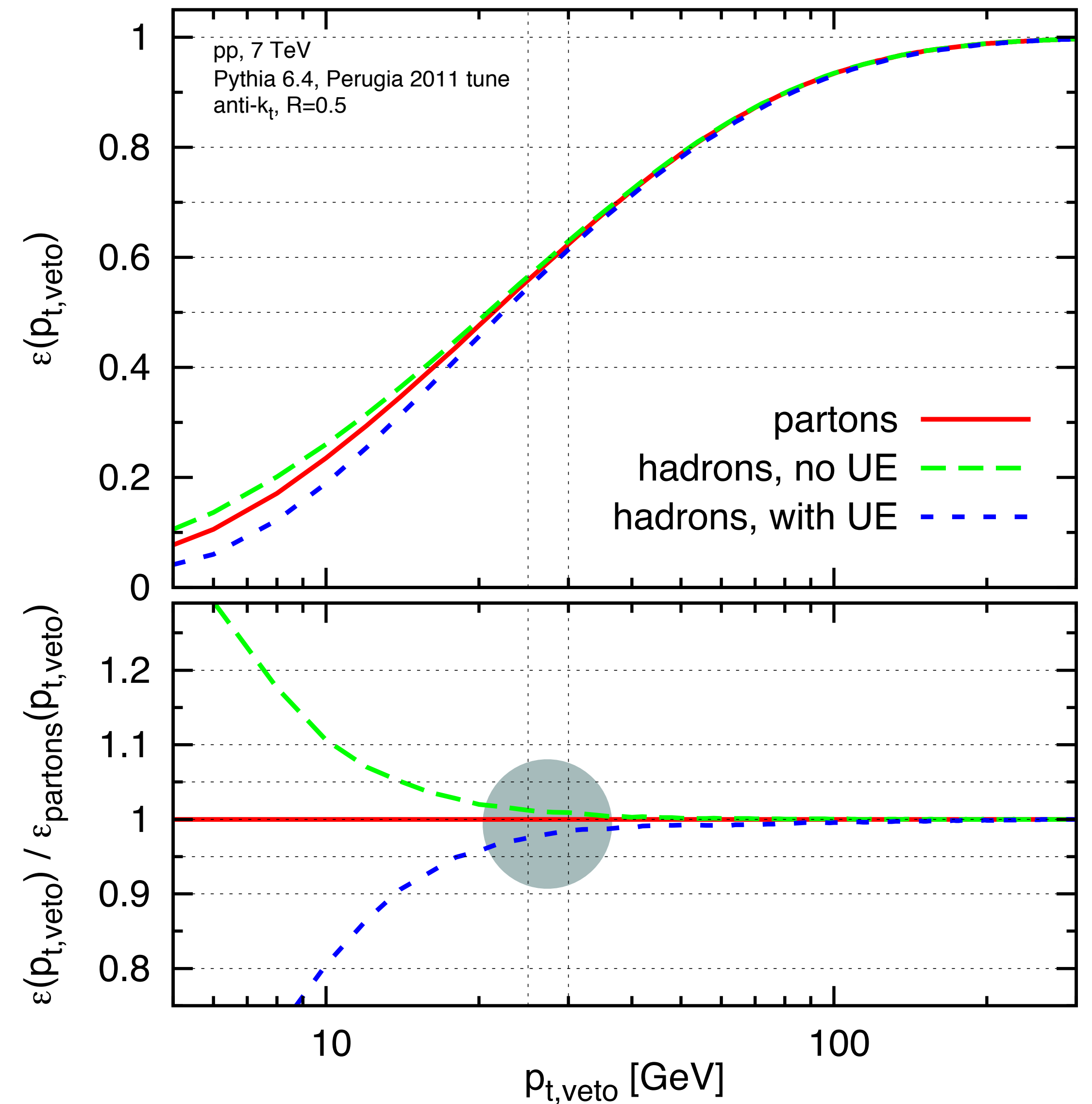

VBF (leading jet)

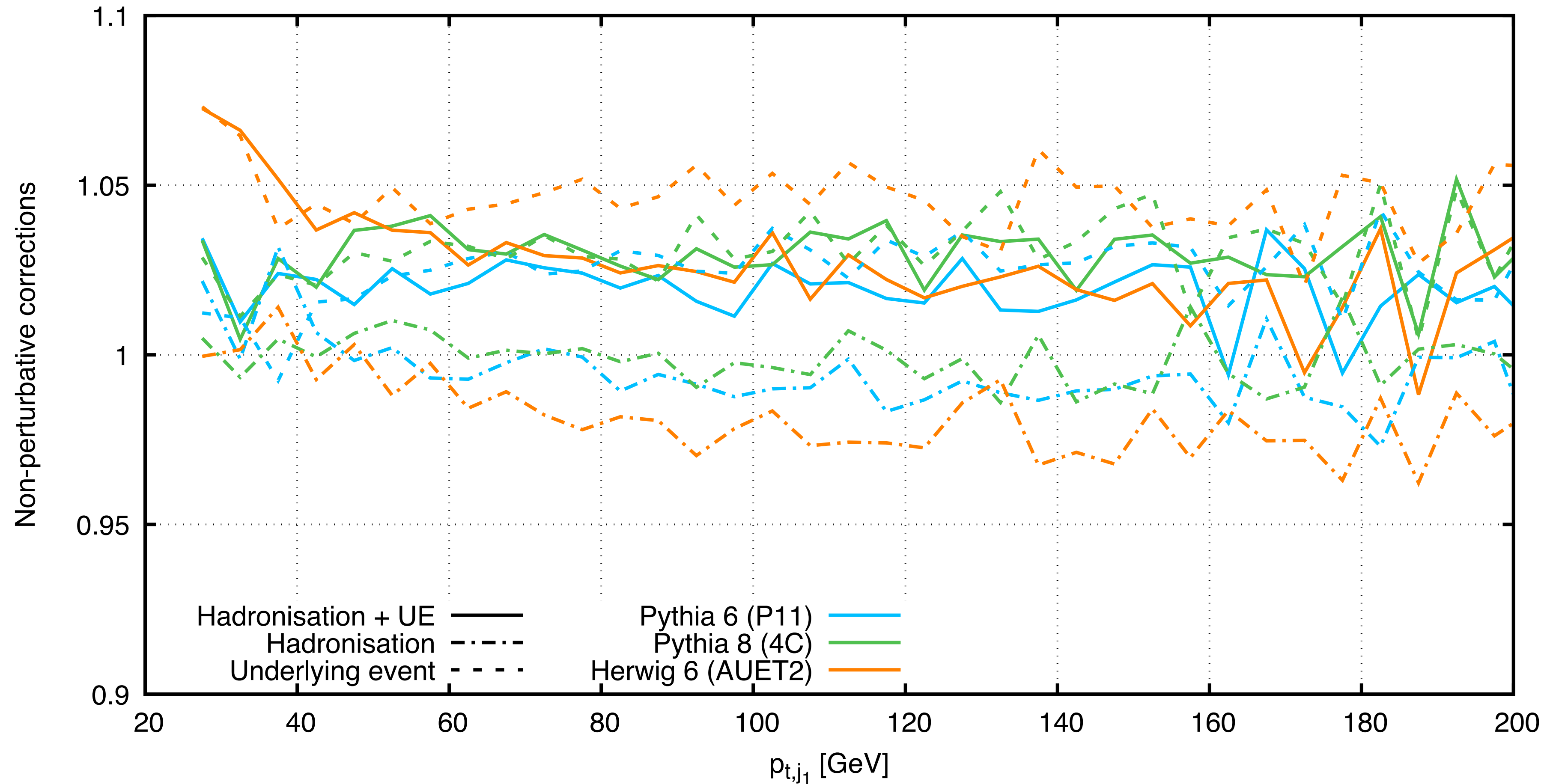

3 - 5% effects

INCLUSIVE JETS

*Dasgupta, Dreyer, GPS
& Soyez, 1602.01110*

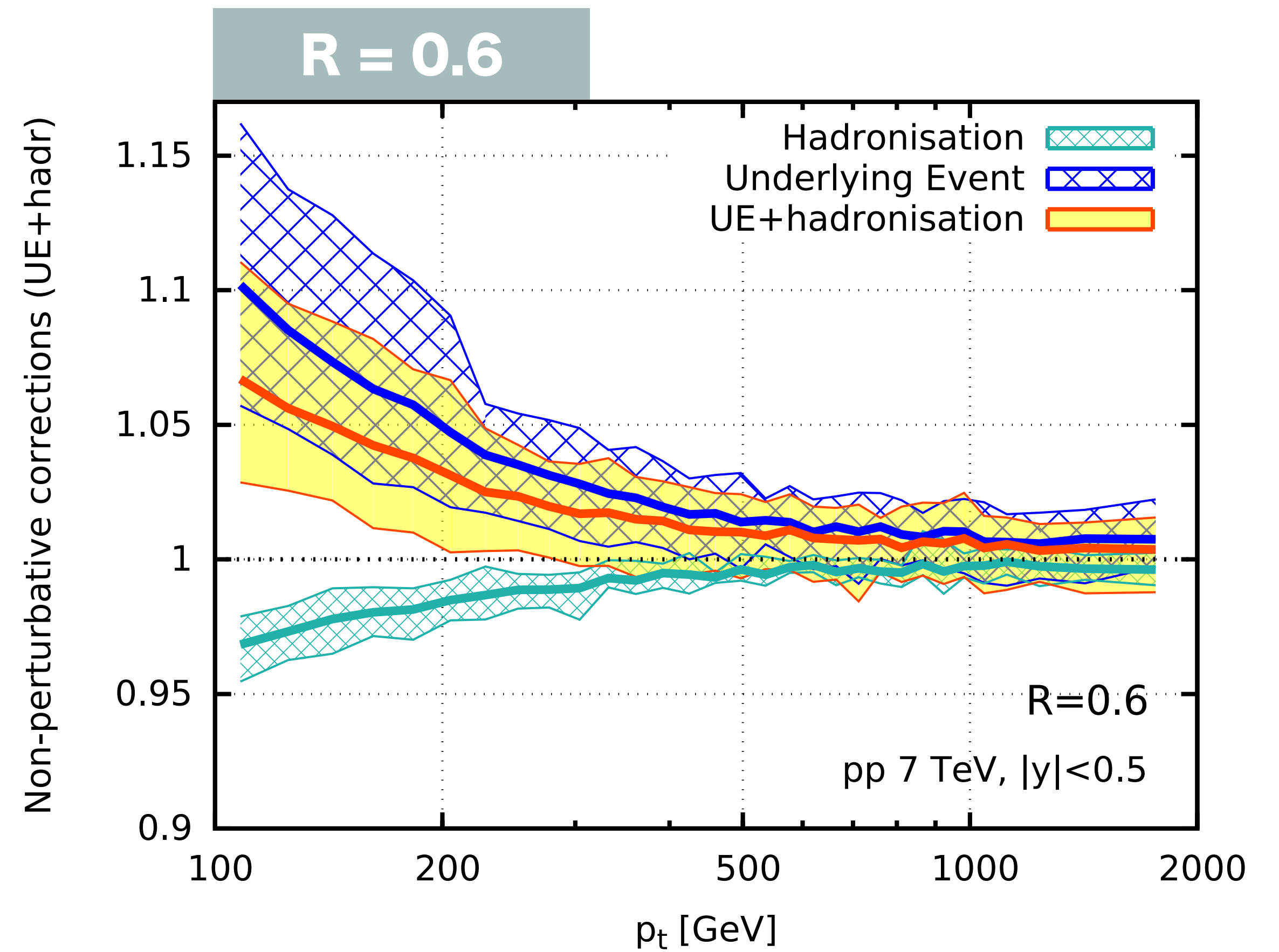
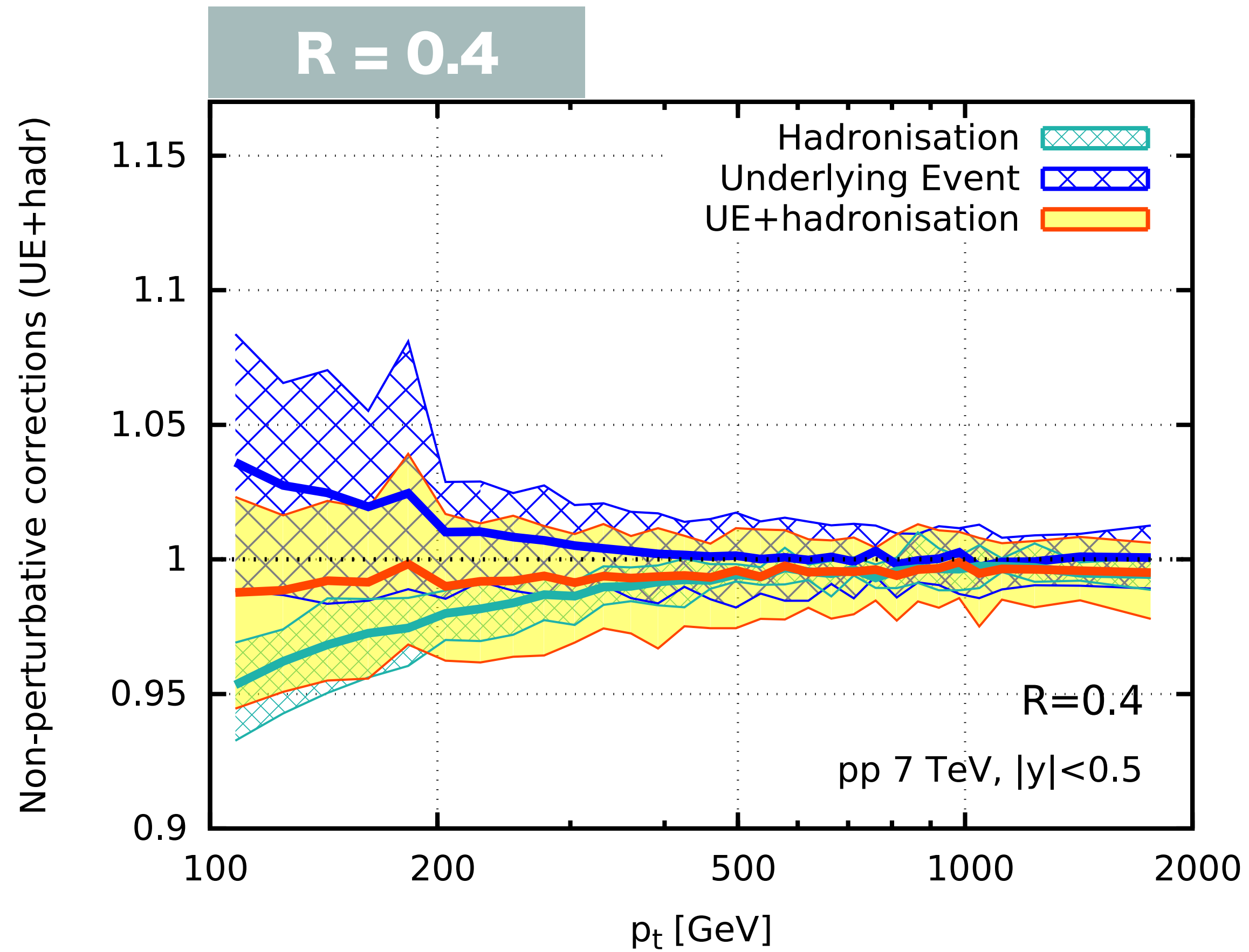

5 - 15% effects

REMARKS

- Non-pert. effects are always relevant at accuracies we're interested in
- Watch out for cancellation between “hadronisation” and MPI/UE (separate physical effects)
- Definition of perturbative / non-perturbative is ambiguous
- Alternative to MC: analytical estimates. MC's have strong p_T dependence, missing in analytical estimates

non-perturbative effects may become a key limitation at 1%

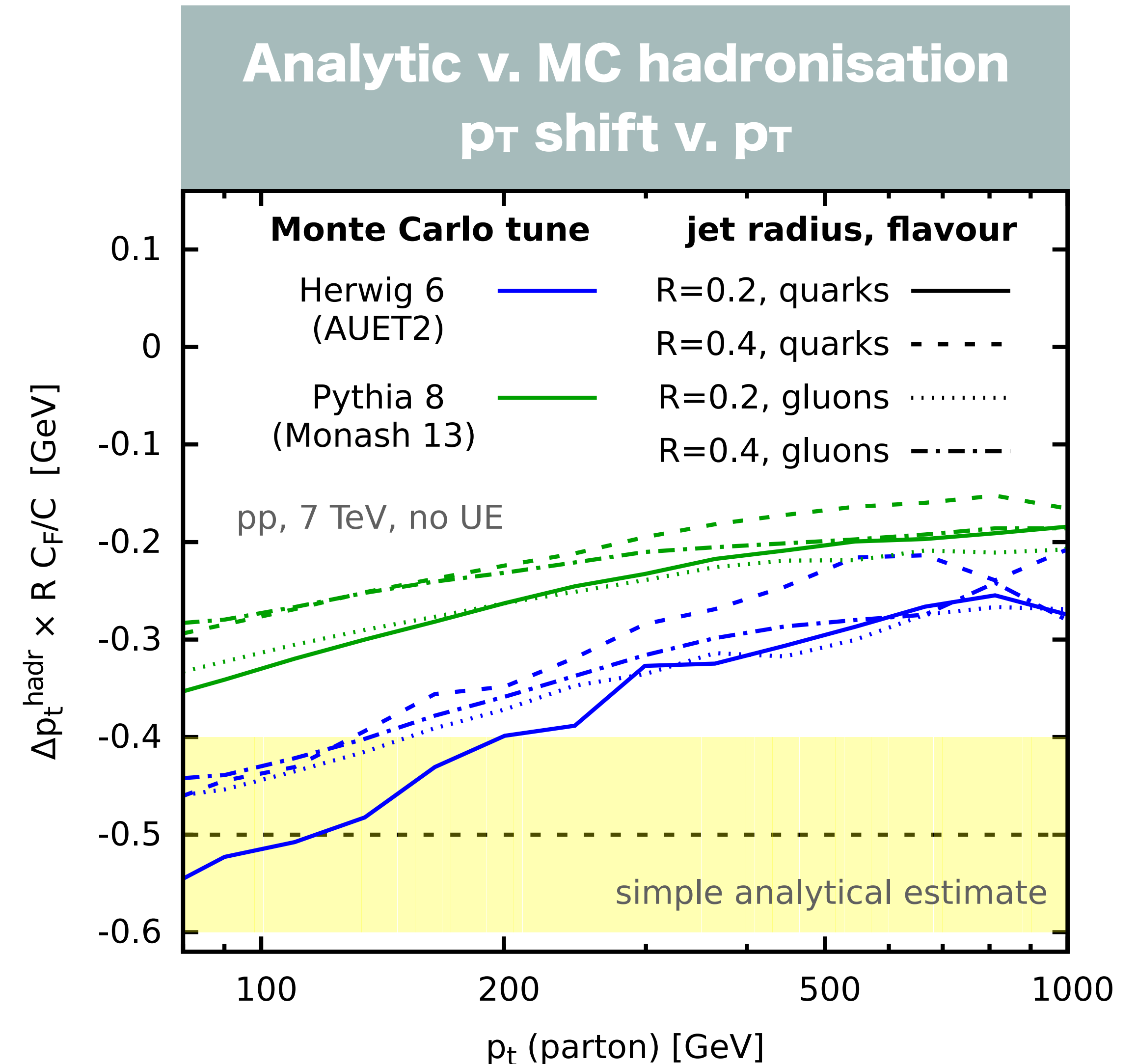

POWERFUL HANDLE: EXPLORE A RANGE OF JET RADII

Dasgupta, Dreyer, GPS
& Soyez, 1602.01110

3 effects:

- perturbative ($\sim \ln R$)
- hadronisation ($\sim 1/R$)
- MPI/UE ($\sim R^2$)

To disentangle them, need ≥ 3 R values:

- 0.6–0.7: large MPI/UE
- 0.4: non-pert. effects cancel?
- **0.2–0.3: large hadronisation**

ratio of inclusive jet spectra at $R=0.4$ and 0.6

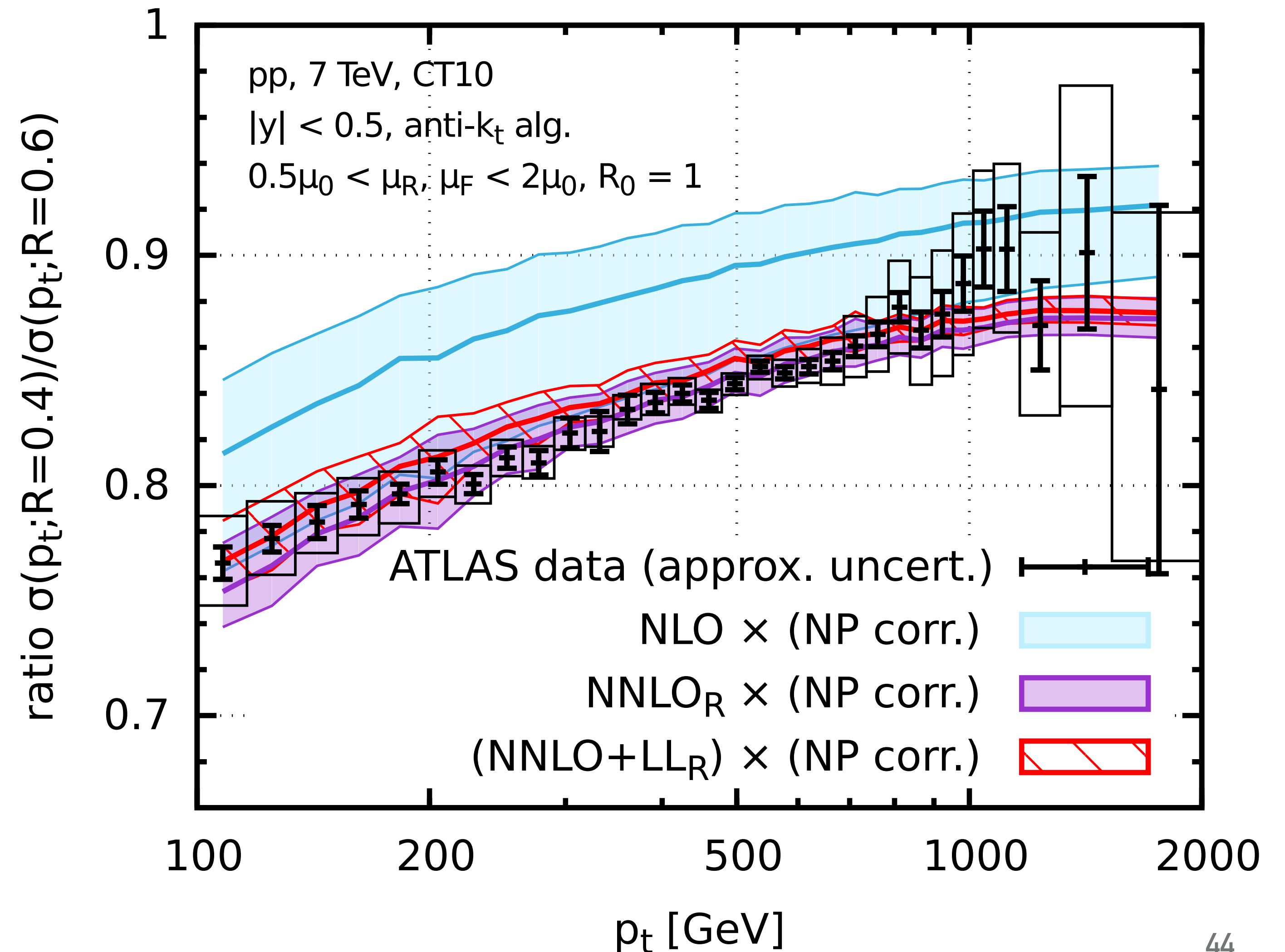

POWERFUL HANDLE: EXPLORE A RANGE OF JET RADII

Dasgupta, Dreyer, GPS
& Soyez, 1602.01110

3 effects:

- perturbative ($\sim \ln R$)
- hadronisation ($\sim 1/R$)
- MPI/UE ($\sim R^2$)

To disentangle them, need ≥ 3 R values:

- 0.6–0.7: large MPI/UE
- 0.4: non-pert. effects cancel?
- **0.2–0.3: large hadronisation**

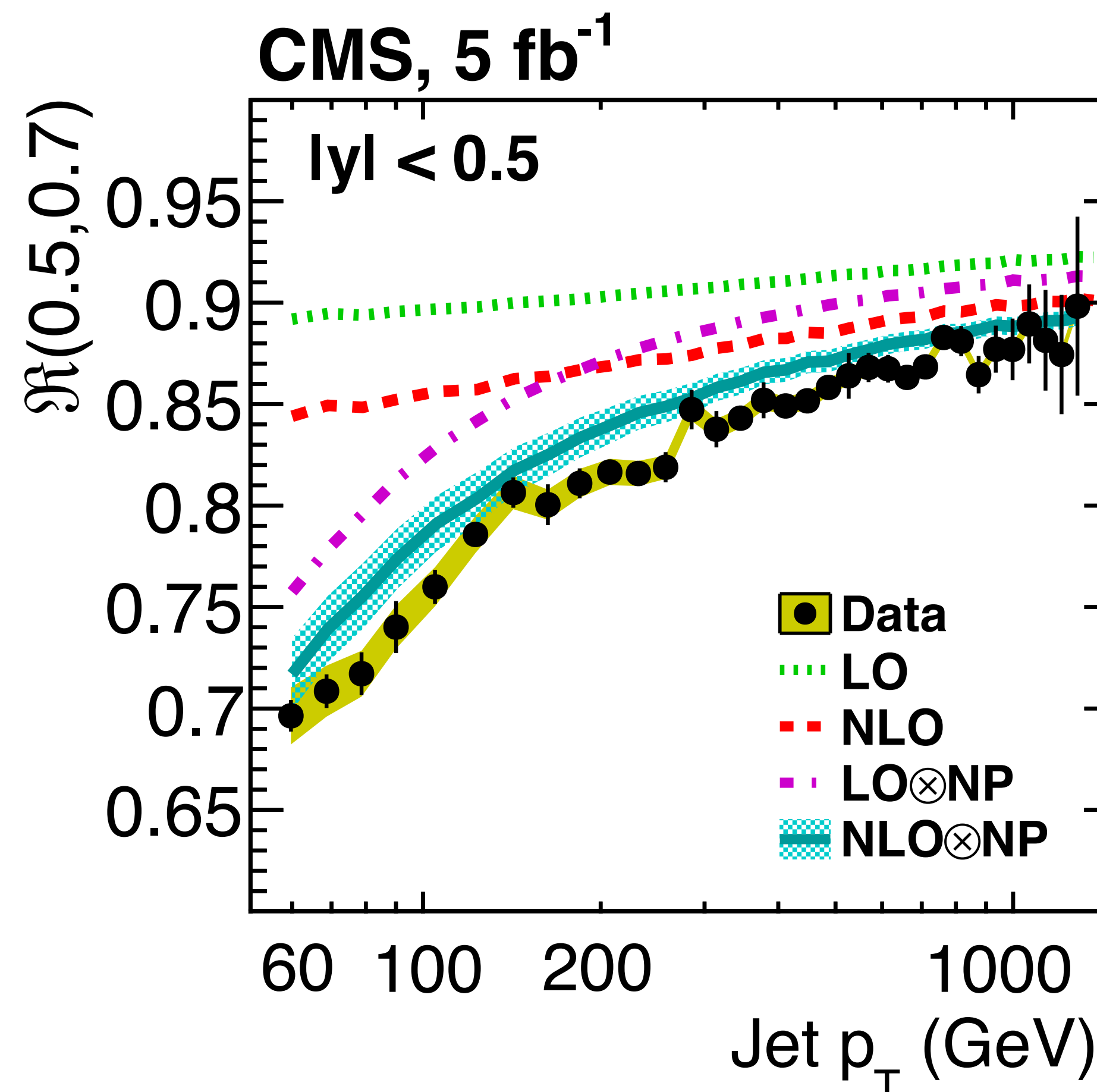

*this uses ratio from Soyez 1101.2665
(NLO is NLO 3-jet; NP is analytical)*

POWERFUL HANDLE: EXPLORE A RANGE OF JET RADII

*Dasgupta, Dreyer, GPS
& Soyez, 1602.01110*

3 effects:

- perturbative ($\sim \ln R$)
- hadronisation ($\sim 1/R$)
- MPI/UE ($\sim R^2$)

To disentangle them, need ≥ 3 R values:

- 0.6–0.7: large MPI/UE
- 0.4: non-pert. effects cancel?
- **0.2–0.3: large hadronisation**

This one usually missing (except ALICE); needs small-R resummation

ratio of inclusive jets at R=0.2 and 0.4

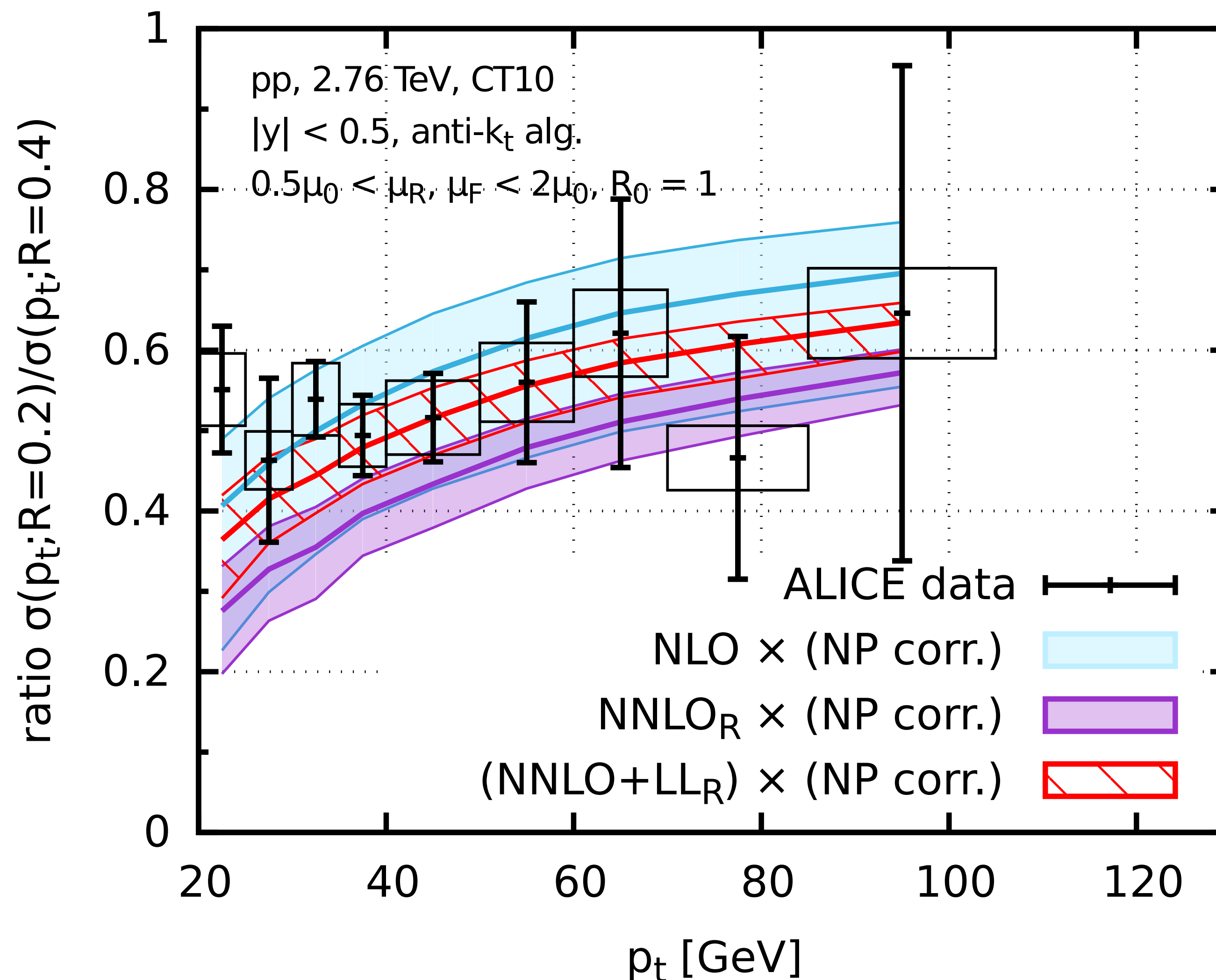

COMMENTS / CONCLUSIONS

- 1% precision is something that we will want to reach for a range of processes to get full value out of the “precision” part of LHC’s programme (Higgs, top, dilepton, ...)
- We’re entering the precision era today, notably with 1% Z p_T distribution (first hadron-collider process $\propto \alpha_s$ known with this precision)
- Even a Z can have non-perturbative corrections — framework for understanding these remains to be developed...
- Processes with jets need a dedicated effort to improve the precision

BACKUP

EXPERIMENTAL PERSPECTIVES

Generation of pseudo-data: the Z pt

- Generate pseudo-data for the **transverse momentum distribution of Z bosons decaying into leptons**
- Statistical uncertainties determined from **number of events per bin**, after a binning optimisation
- Added a **2% systematic uncertainty** to the statistical uncertainty

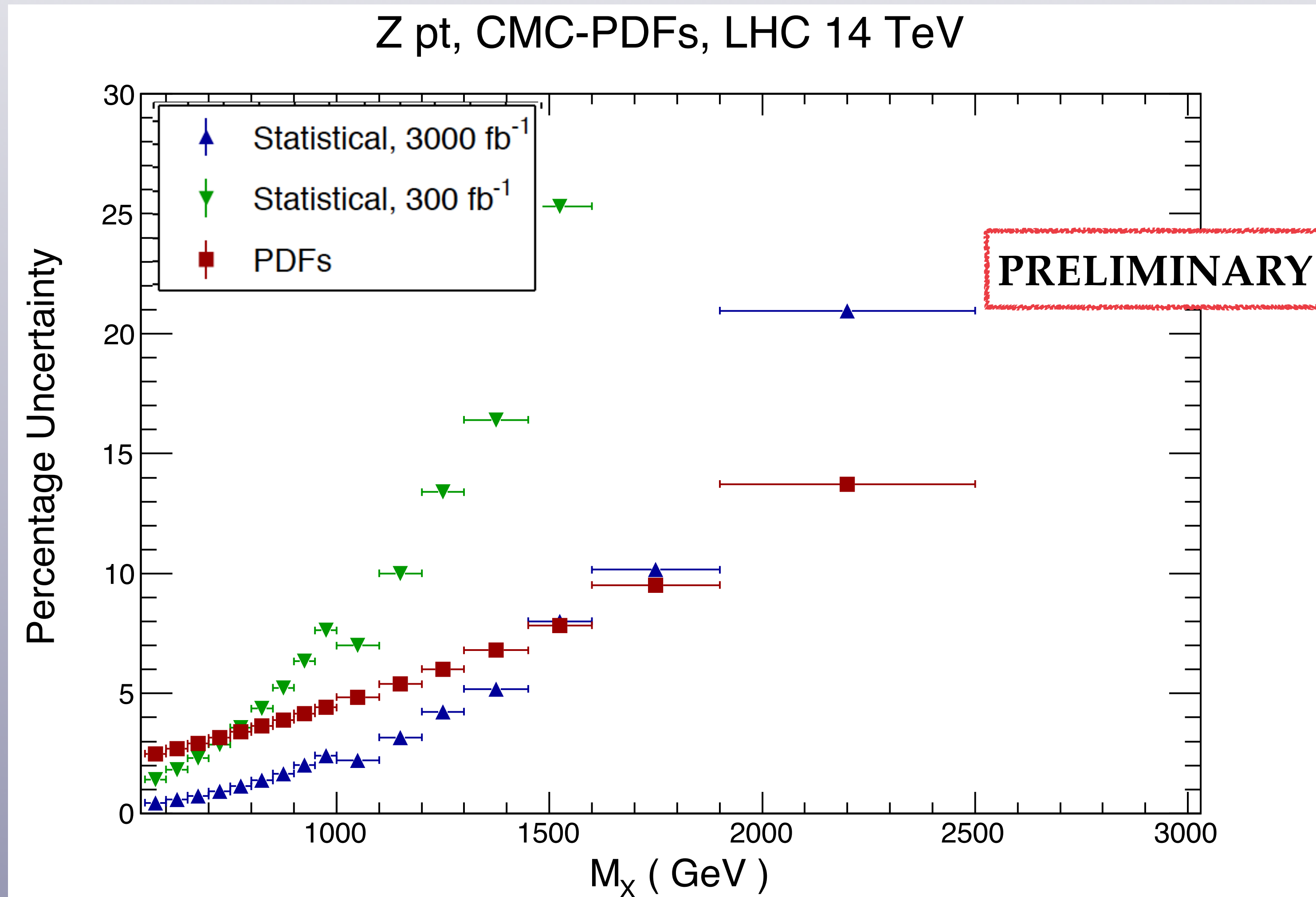

Generation of pseudo-data: high-mass Drell-Yan

- Generate pseudo-data for the **invariant mass distribution** of **di-electrons** and **di-muons**
- Statistical uncertainties determined from **number of events per bin**, after a binning optimisation
- Added a **2% systematic uncertainty** to the statistical uncertainty

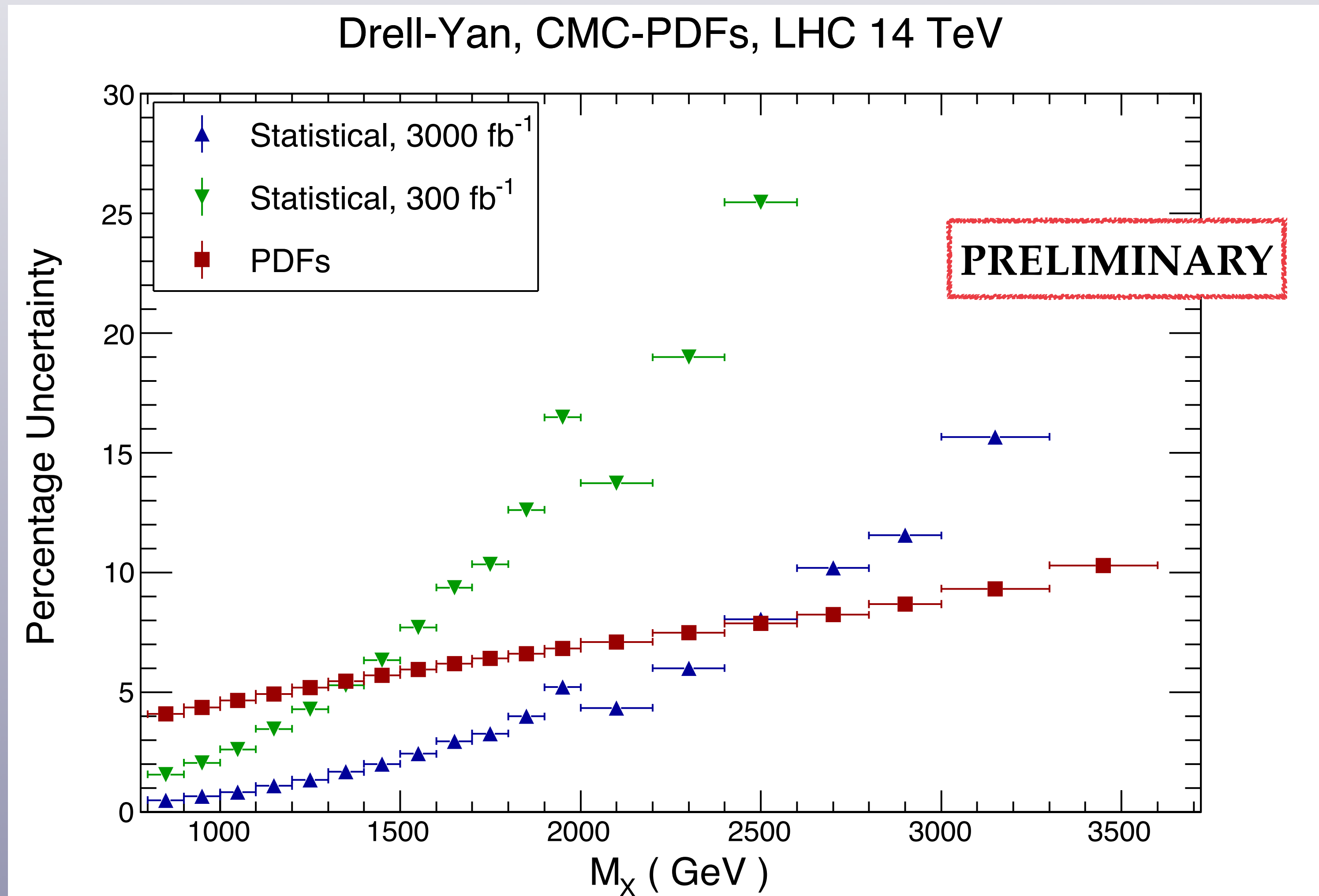

Generation of pseudo-data: top quark pair

- Generate pseudo-data for the **invariant mass distribution** in the **leptonic final state**
- Statistical uncertainties determined from **number of events per bin**, after a binning optimisation
- Added a **3% systematic uncertainty** to the statistical uncertainty

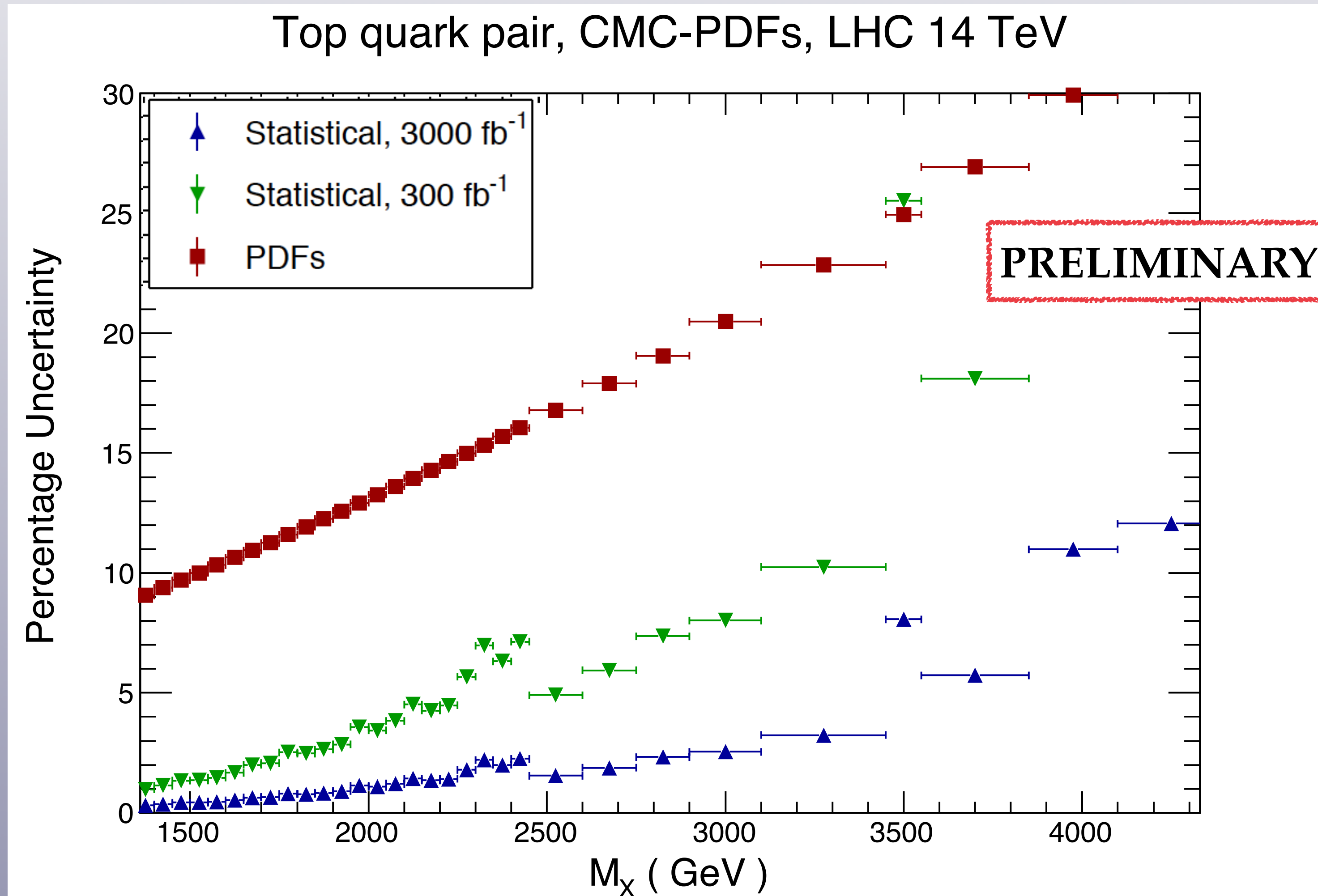

ABSOLUTE CROSS-SECTIONS MEASURED TO $\sim 1\%$?

Beam Imaging and Luminosity Calibration

arXiv:1603.03566v1 [hep-ex]

March 14, 2016

Markus Klute, Catherine Medlock, Jakob Salfeld-Nebgen
Massachusetts Institute of Technology

We discuss a method to reconstruct two-dimensional proton bunch densities using vertex distributions accumulated during LHC beam-beam scans. The x - y correlations in the beam shapes are studied and an alternative luminosity calibration technique is introduced. We demonstrate the method on simulated beam-beam scans and estimate the uncertainty on the luminosity calibration associated to the beam-shape reconstruction to be below 1%.

Z P_T

CMS Z p_T uncertainties (normalised to total fiducial)

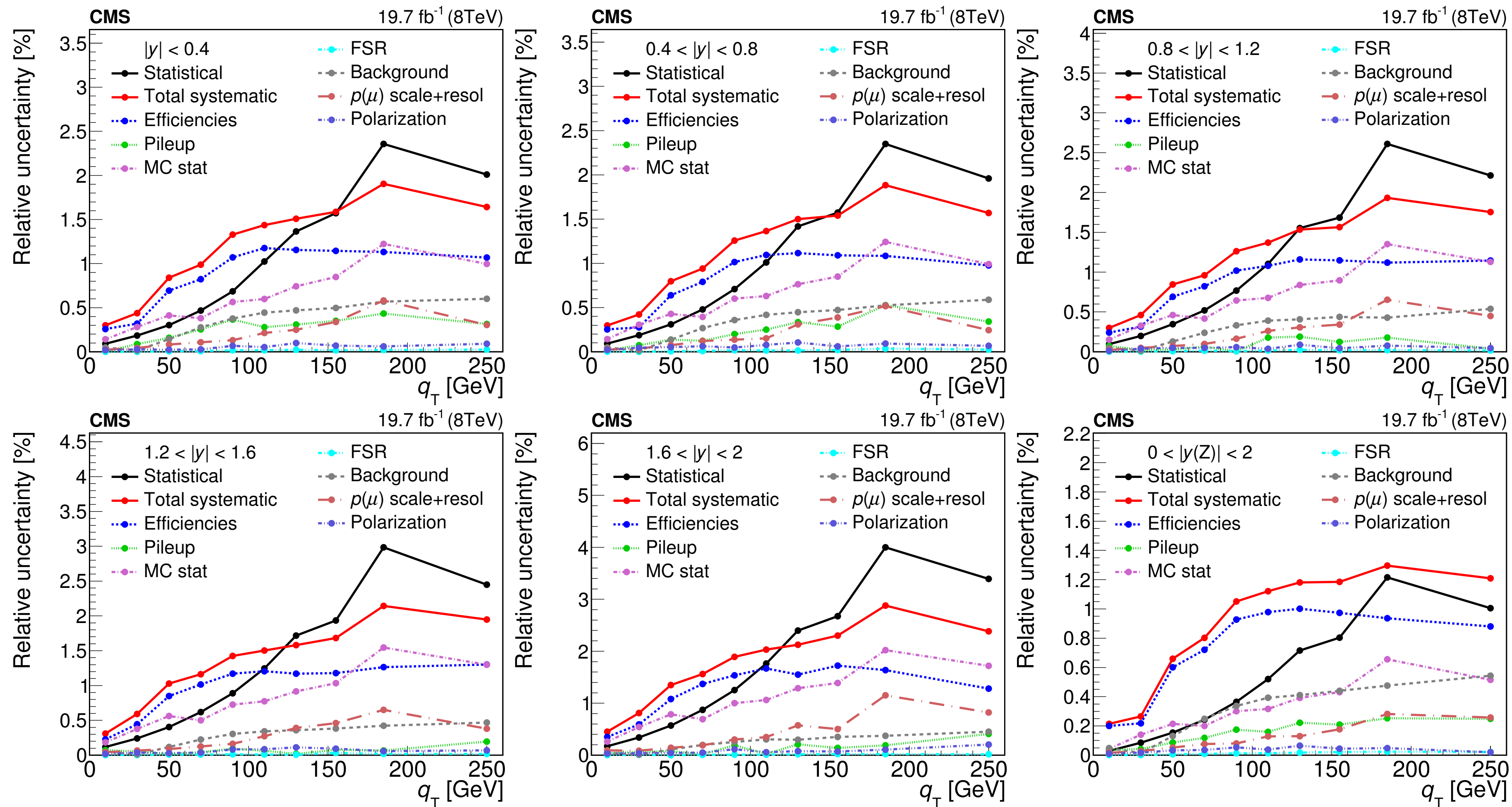

Uncertainties seem significantly larger for CMS.

Where are the differences wrt ATLAS?

1504.03511

Figure 1: Relative uncertainties in percent of the normalised fiducial cross section measurement. Each plot shows the q_T dependence in the indicated ranges of $|y|$.

ATLAS Z p_T uncertainties (normalised to total fiducial)

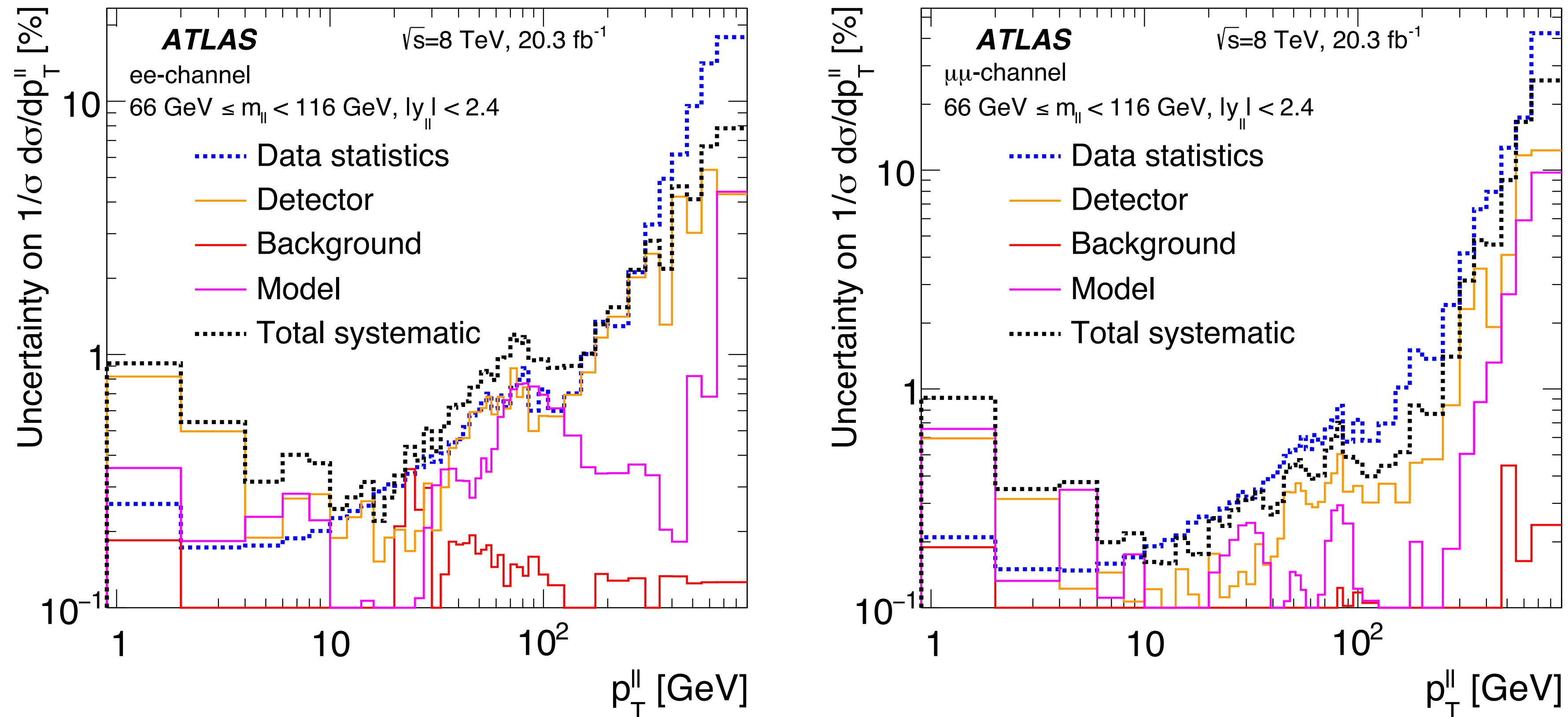

Uncertainties seem significantly larger for CMS.

Where are the differences wrt ATLAS?

1512.02912

Figure 4: Uncertainty from various sources on $(1/\sigma) d\sigma/d\phi_{\eta}^*$ (top) and $(1/\sigma) d\sigma/dp_T^{\ell\ell}$ (bottom) for events with $66 \text{ GeV} < m_{\ell\ell} < 116 \text{ GeV}$ and $|y_{\ell\ell}| < 2.4$. Left: electron-pair channel at dressed level. Right: muon-pair channel at bare level.

VBF HIGGS PRODUCTION

Structure Function Approach

One can think of VBF Higgs production as a double Deep Inelastic Scattering ($\text{DIS} \times \text{DIS}$) with no cross-talk between the upper and **lower** sectors.

[Han, Valencia, Willenbrock (1992)]

- this picture is accurate to more than 1%

[Bolzoni et al. (2012)], [Ciccolini, Denner, Dittmaier (2008)], [Andersen et al. (2008)]

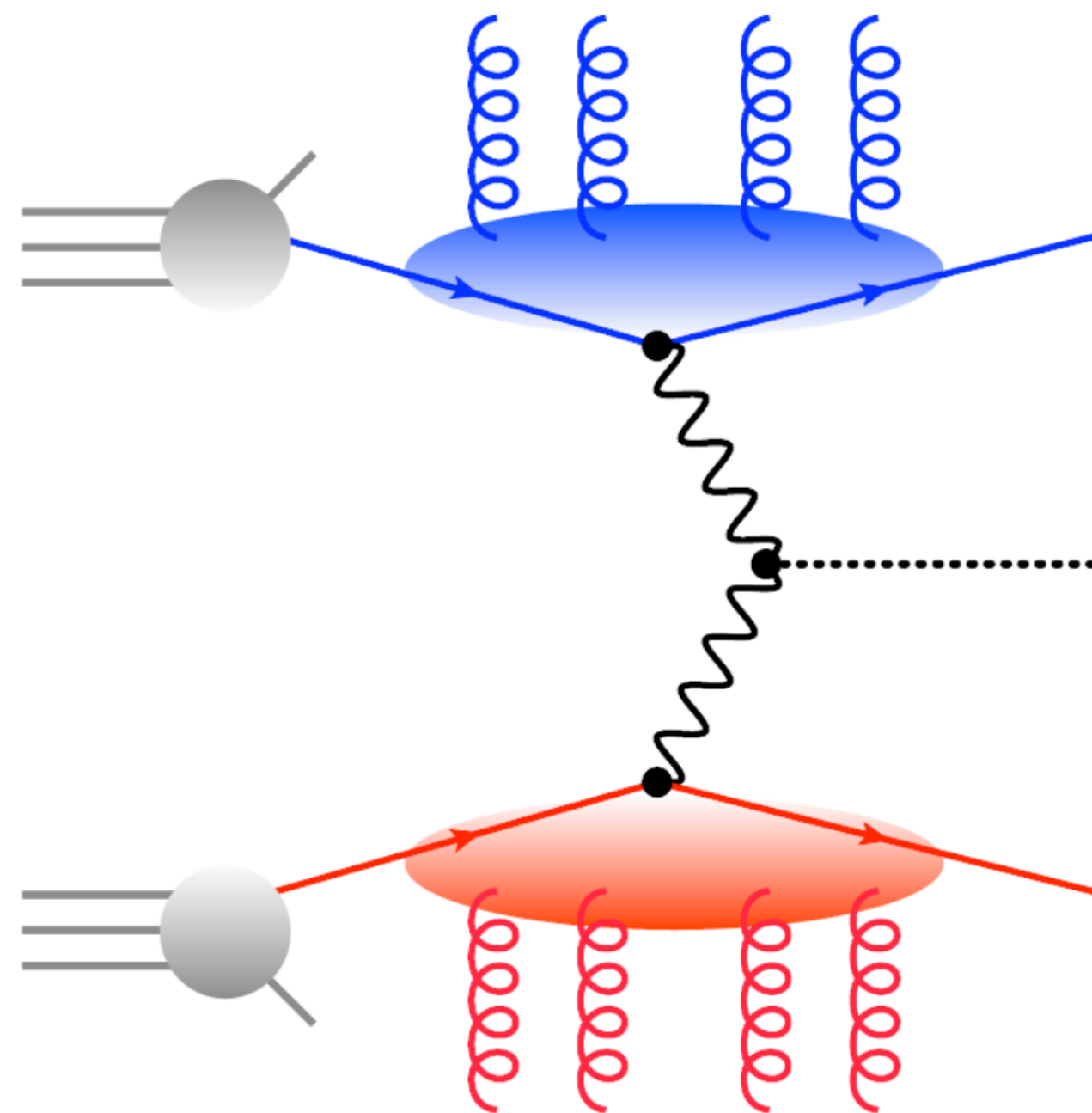

- the factorisation of the two sectors is exact if one imagines two copies of QCD, QCD_1 and QCD_2 , respectively for the upper and lower sectors.
- all DIS coefficients are known to NNLO and almost all to N^3LO .
- as the DIS coefficients are inclusive over the hadronic final state, **the calculation cannot provide differential results.**

Beyond the Structure Function Approach

The calculation is based on **two ingredients**:

1. An “inclusive” contribution

- use the Structure Function Approach and use four-vectors q_1, q_2 to assign Born-like kinematics using the equations below
- use the projected Born-like momenta to compute differential distributions

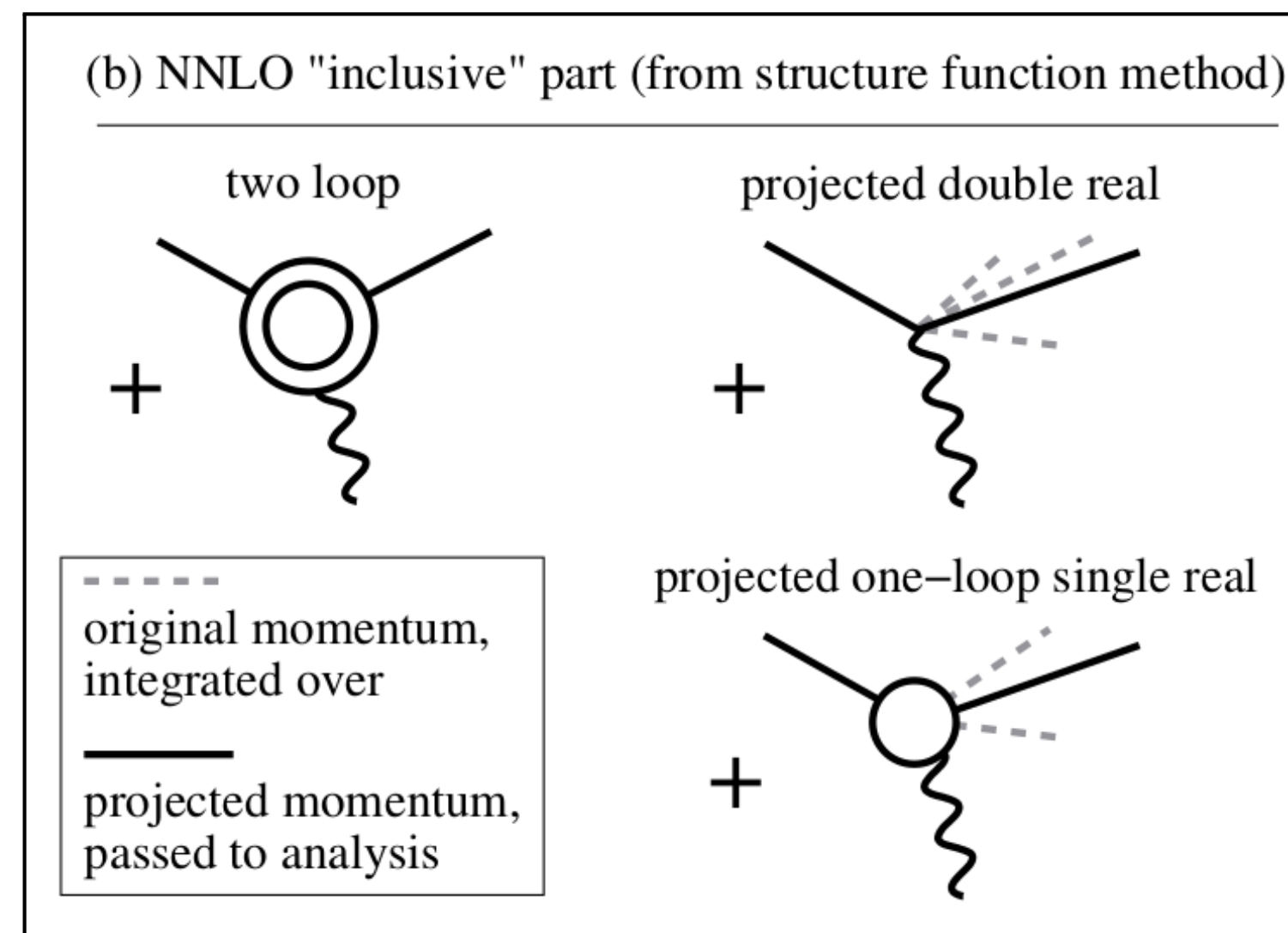

$$p_{in,i} = x_i P_i$$

$$p_{out,i} = x_i P_i - q_i$$

$$x_i = \frac{q_i^2}{2q_i P_i}$$

Beyond the Structure Function Approach

The calculation is based on **two ingredients**:

2. An “exclusive” contribution

- use the electroweak $H + jjj$ NLO calculation in the factorized approximation

[Figy et al. (2007)], [Jäger et al. (2014)]

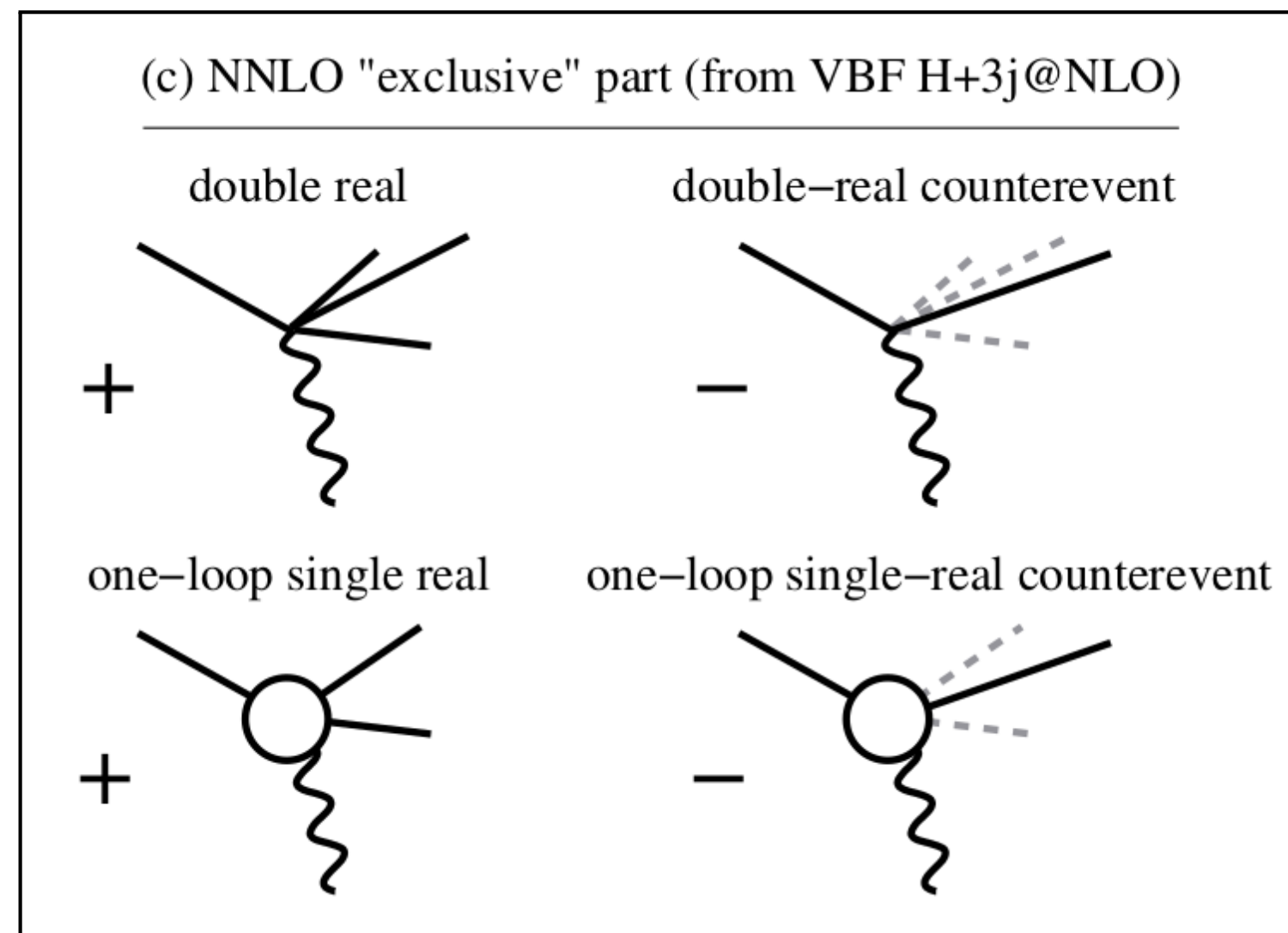

- for each parton, keep track of whether it belongs to the upper or lower sector, and compute vector-boson momenta q_1, q_2
- for each event add **counter-event with projected Born kinematics** and opposite weight

The counter-events **cancel** identically with the projected terms from the “inclusive” contribution.

Beyond the Structure Function Approach

Schematically we express the “projection-to-Born” (P2B) method as

$$\begin{aligned}
 d\sigma &= \int d\Phi_B (B + V) + \int d\Phi_R R \\
 &= \underbrace{\int d\Phi_B (B + V) + \int d\Phi_R R_{P2B}}_{\text{“inclusive” contribution}} + \underbrace{\int d\Phi_R R - \int d\Phi_R R_{P2B}}_{\text{“exclusive” contribution}}
 \end{aligned}$$

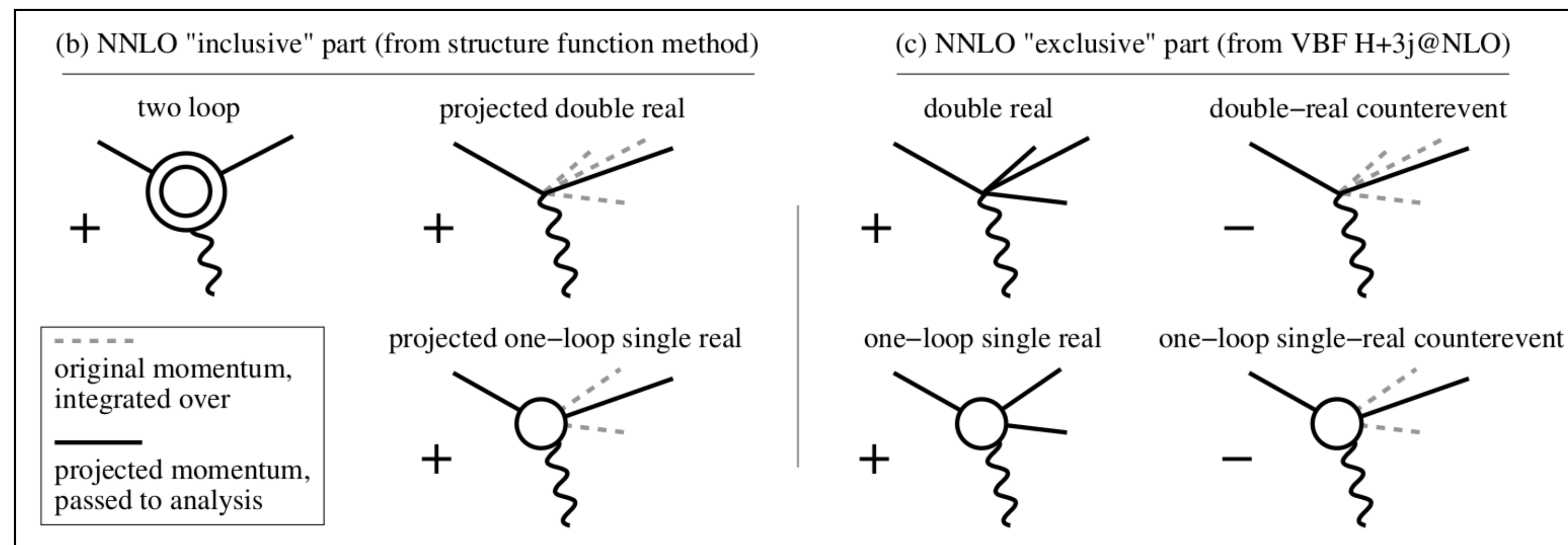

Phenomenology

We study 13 TeV LHC collisions with $M_H = 125$ GeV and NNPDF3.0_nnlo_as118. We use the following VBF cuts:

- Jets defined with anti- k_t , $R = 0.4$ and $p_t > 25$ GeV
- Two hardest jets within $|y| < 4.5$
- High dijet invariant mass, $M_{j_1j_2} > 600$ GeV, and separation, $\Delta y_{j_1j_2} > 4.5$
- Hardest jets in opposite hemispheres, $y_{j_1}y_{j_2} < 0$

We choose a central scale which approximates well $\sqrt{Q_1 Q_2}$ and symmetrically vary by a factor 2 up and down

$$\mu_0^2(p_{t,H}) = \frac{M_H}{2} \sqrt{\left(\frac{M_H}{2}\right)^2 + p_{t,H}^2}$$

SMALL-R

NLL SMALL-R TERMS

