

Dynamical vertex approximation - a step beyond DMFT

Karsten Held*

IFP TU Wien

KITP Workshop Materials10, Feb. 5 2010

- Motivation
- Dynamical vertex approximation (D Γ A)
- Effect of spin fluctuations on Mott transition (3D)
- Pseudogap in 2D
- Phase diagram and critical exponents

* with A. Toschi and A. Katanin *PRB* 75, 45118 (2007);

PRB 80, 75104 (2009), *Prog Theor Phys Suppl* 176, 117 (2008)

Motivation

Dynamical mean field theory

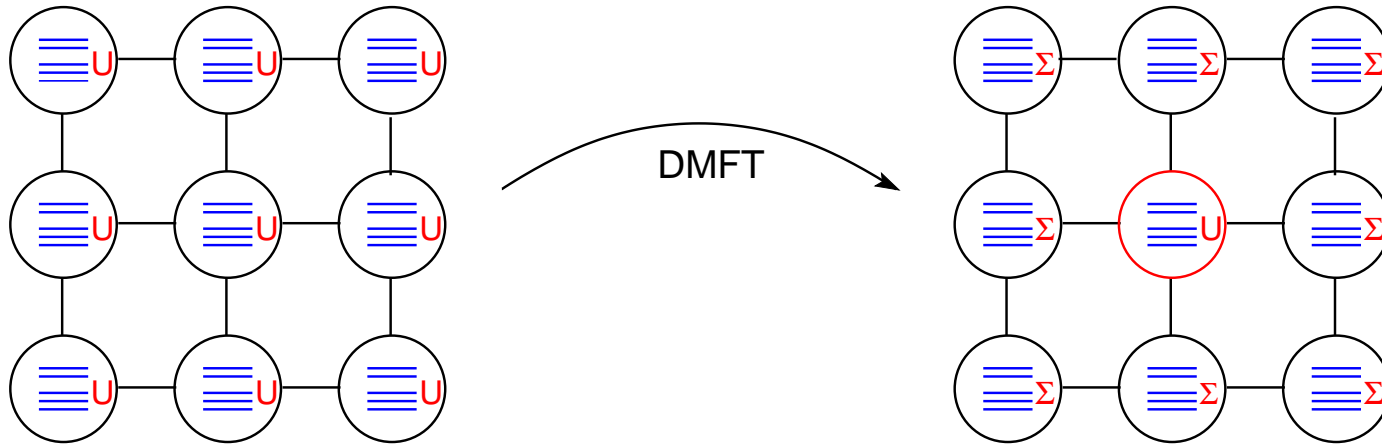

Σ all topologically distinct, but **local** diagrams

Success story: quasiparticle renormalizations, magnetism, kinks ...

Motivation

Dynamical mean field theory

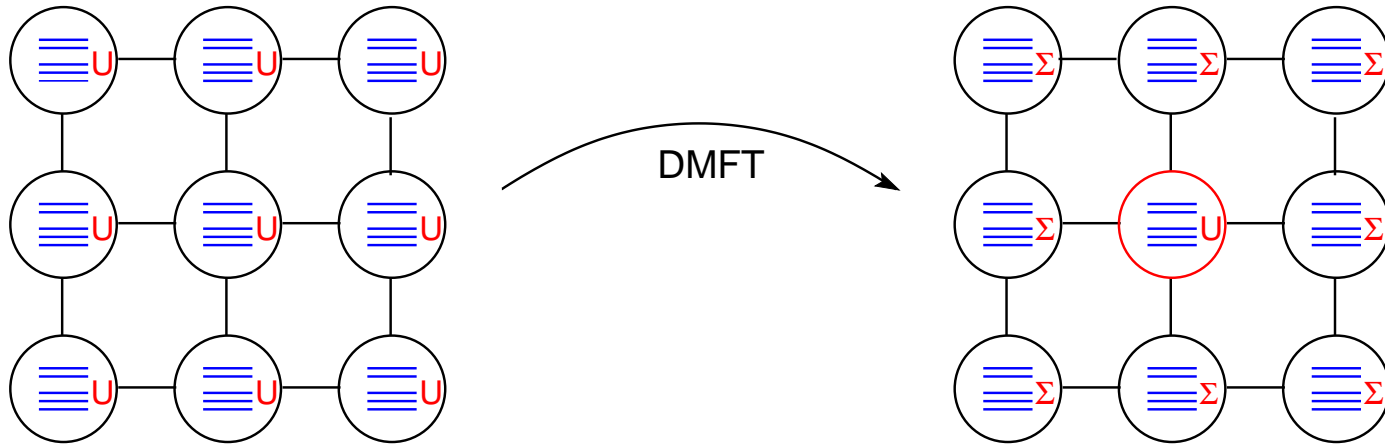

Σ all topologically distinct, but **local** diagrams

Success story: quasiparticle renormalizations, magnetism, kinks ...

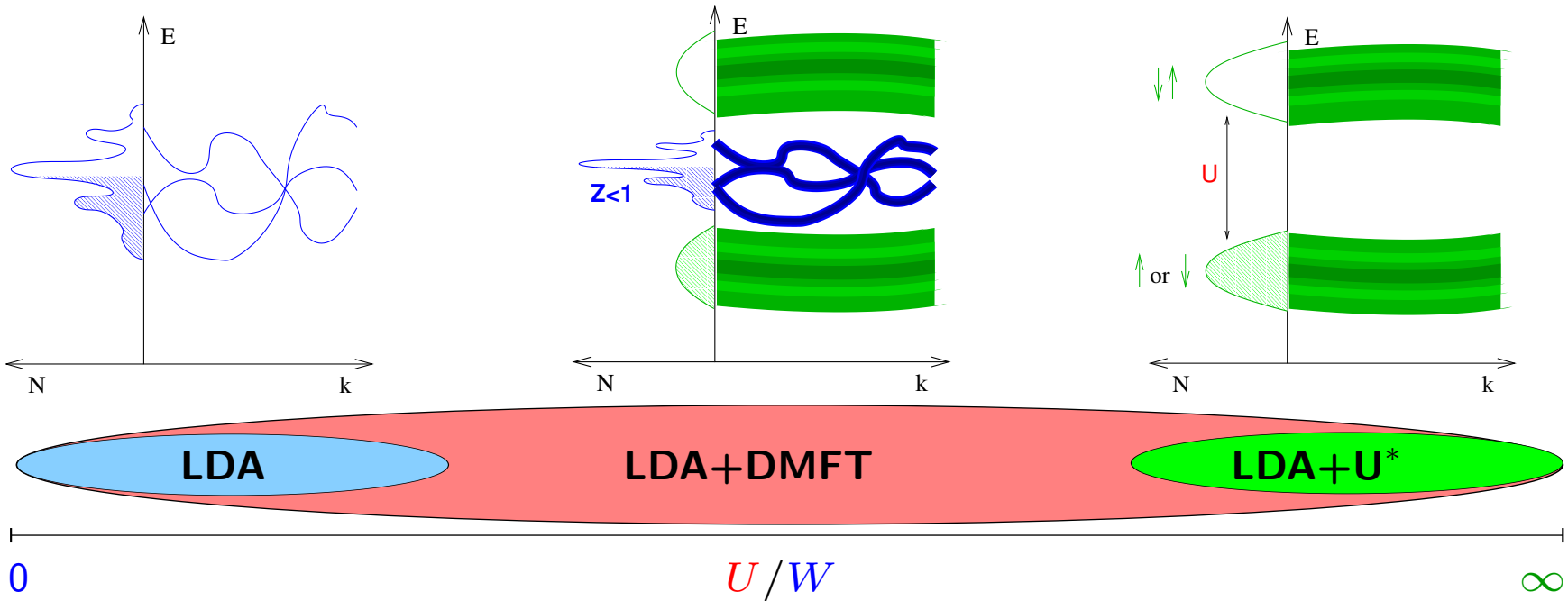

Motivation

Dynamical mean field theory

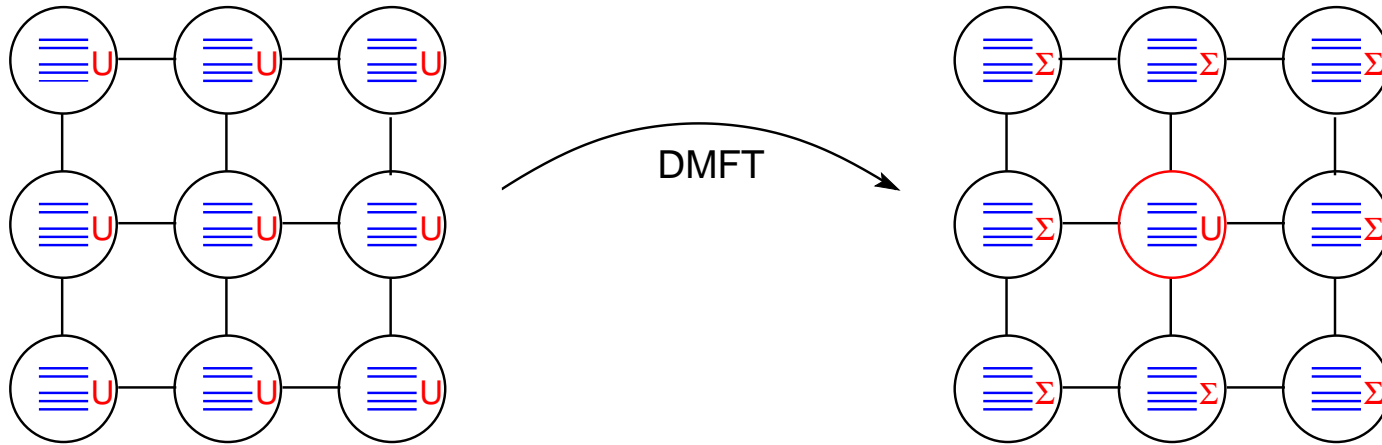

Σ all topologically distinct, but **local** diagrams

Success story: quasiparticle renormalizations, magnetism, kinks ...

Not included:

non-local correlations

p-, *d*-wave superconductivity, pseudogaps, spin Peierls

magnons, (quantum) critical behavior ...

k-dependent Σ

beyond DMFT



cluster extensions of DMFT

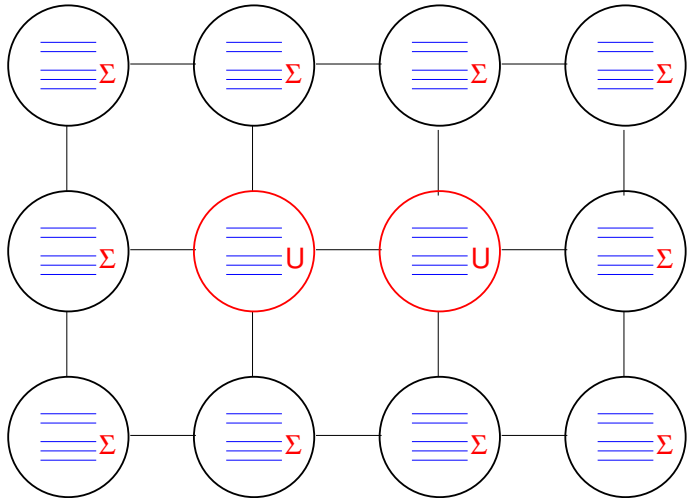

- non-local **short-range** correlations
- d/p -wave superconductivity

Hettler *et al.*'98, Lichtenstein Katsnelson'00,
Kotliar *et al.*'01, Potthoff'03

diagrammatic extensions of DMFT

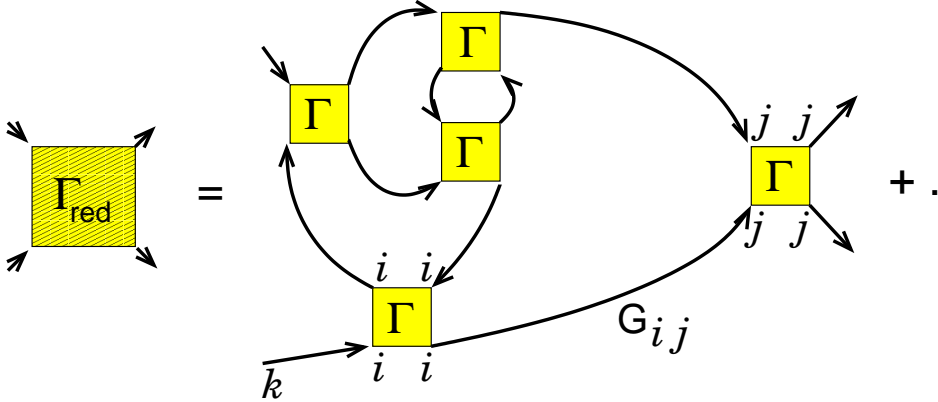

dynamical vertex approximation

- **short and long-range** correlations
- (para-)magnons, criticality ...

Kusunose cond-mat/0602451
Toschi, Katanin, KH cond-mat/0603100
Slezak *et al.* cond-mat/0603421

cf. dual Fermions: Rubtsov *et al.*'08
cf. DMFT+spin-Fermion Kuchinskii *et al.*'05

Dynamical vertex approximation (D Γ A)

DMFT: all (topological distinct) **local** diagram for Σ

Generalization: all **local** diagrams for n -particle fully irreducible vertex Γ

Dynamical vertex approximation (D Γ A)

DMFT: all (topological distinct) **local** diagram for Σ

Generalization: all **local** diagrams for n -particle fully irreducible vertex Γ

$n = 1 \rightarrow$ DMFT

Dynamical vertex approximation (D Γ A)

DMFT: all (topological distinct) **local** diagram for Σ

Generalization: all **local** diagrams for n -particle fully irreducible vertex Γ

$n = 1 \rightarrow$ DMFT

$n = 2 \rightarrow$ D Γ A: from **2-particle** irreducible vertex Γ
construct Σ (**local** and **non-local** diagrams)

Dynamical vertex approximation (D Γ A)

DMFT: all (topological distinct) **local** diagram for Σ

Generalization: all **local** diagrams for n -particle fully irreducible vertex Γ

$n = 1 \rightarrow$ DMFT

$n = 2 \rightarrow$ D Γ A: from **2-particle** irreducible vertex Γ
construct Σ (**local** and **non-local** diagrams)

...

$n = \infty \rightarrow$ exact solution

Dynamical vertex approximation (D Γ A)

DMFT: all (topological distinct) **local** diagram for Σ

Generalization: all **local** diagrams for n -particle fully irreducible vertex Γ

$n = 1 \rightarrow$ DMFT

$n = 2 \rightarrow$ D Γ A: from **2-particle** irreducible vertex Γ
construct Σ (**local** and **non-local** diagrams)

...

$n = \infty \rightarrow$ exact solution

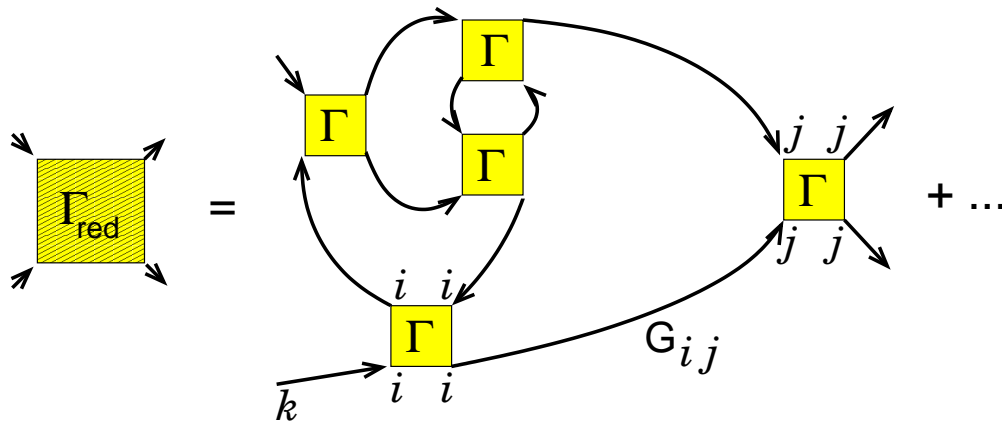

local Γ , **non-local** G

\rightarrow

non-local reducible vertex Γ_{red}

via parquet equations

Dynamical vertex approximation (D Γ A)

DMFT: all (topological distinct) **local** diagram for Σ

Generalization: all **local** diagrams for n -particle fully irreducible vertex Γ

$n = 1 \rightarrow$ DMFT

$n = 2 \rightarrow$ D Γ A: from **2-particle** irreducible vertex Γ
construct Σ (**local** and **non-local** diagrams)

...

$n = \infty \rightarrow$ exact solution

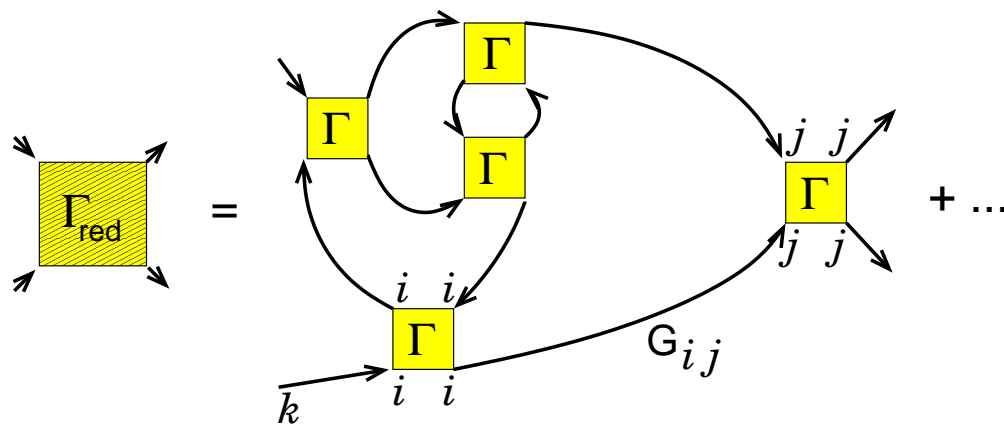

local Γ , **non-local** G

\rightarrow

non-local reducible vertex Γ_{red}

via parquet equations

$\Sigma =$

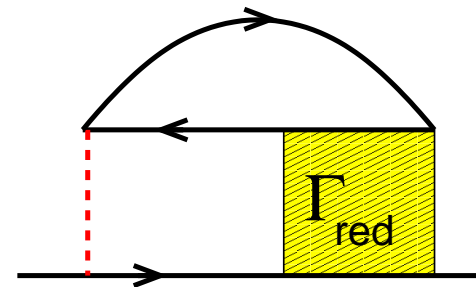

Γ_{red}

\rightarrow

non-local Σ

exact relation (eq. of motion)

Dynamical vertex approximation (DΓA)

DMFT: all (topological distinct) **local** diagram for Σ

Generalization: all **local** diagrams for n -particle fully irreducible vertex Γ

$n = 1 \rightarrow$ DMFT

$n = 2 \rightarrow$ **DΓA:** from **2-particle** irreducible vertex Γ
construct Σ (**local** and **non-local** diagrams)

...

$n = \infty \rightarrow$ exact solution

First step: restriction to ladder diagrams

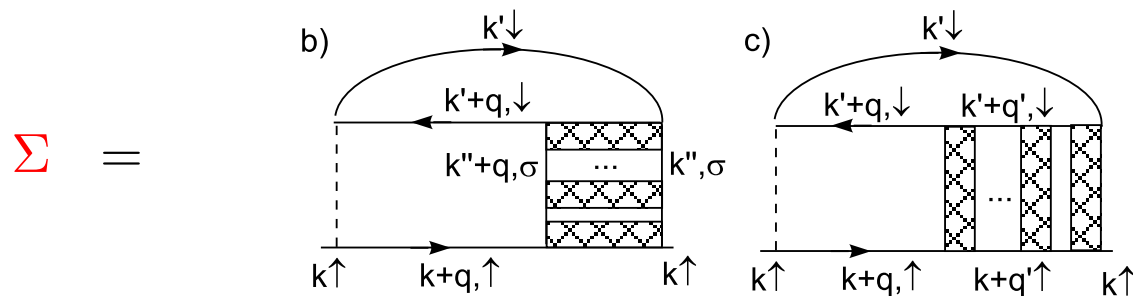

lines: **non-local** G

crosshatched: local irreducible vertex in spin/charge channels

$$\Gamma_{S,C}(\nu, \nu', \omega) = \chi_{0,loc}^{-1} - \chi_{S,C}^{-1}$$

magnons, spin-fluctuations at (A)FM phase transition

G_{ij} from DMFT

DΓA algorithm (full version)

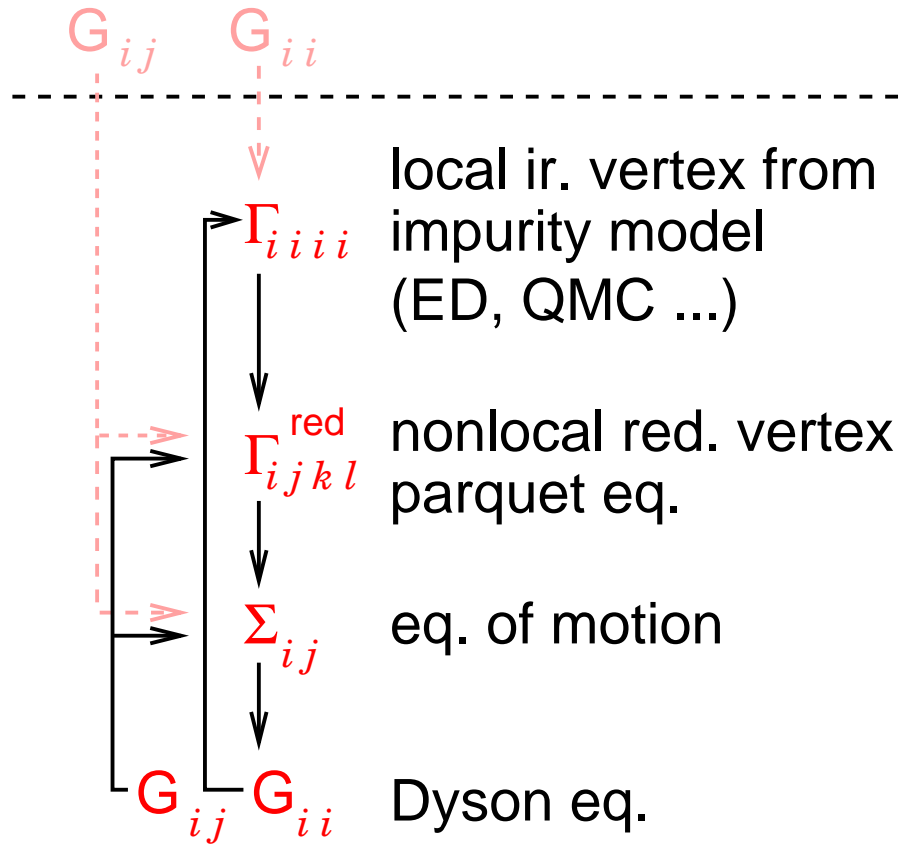

DΓA algorithm (restriction to ph ladders)

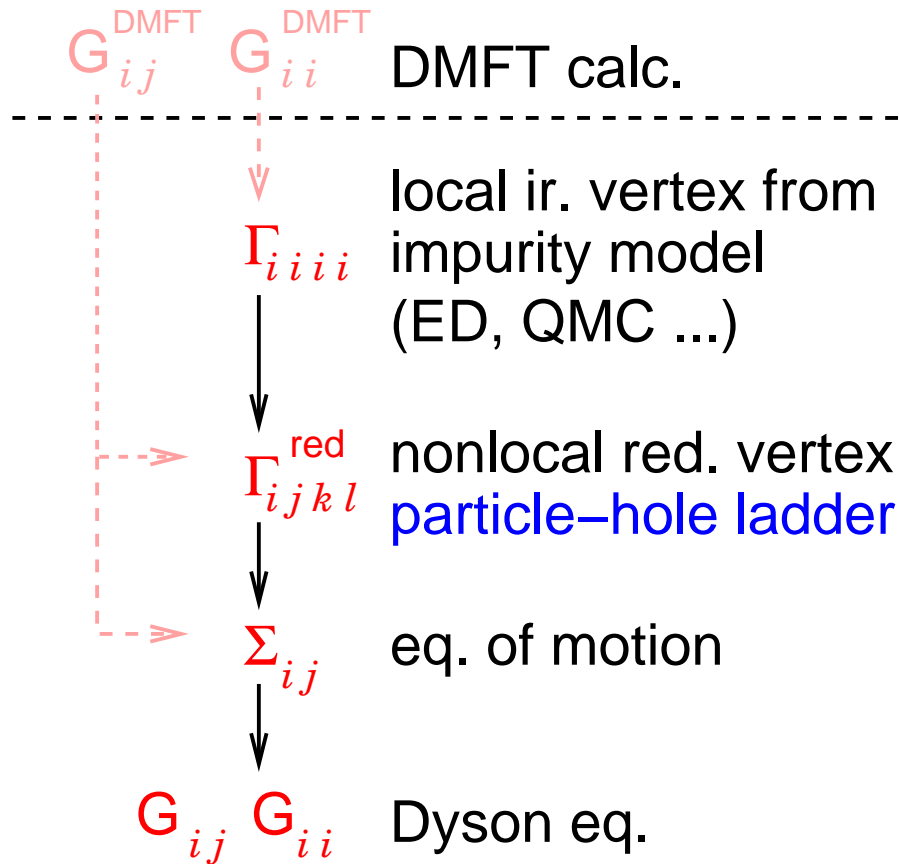

DΓA algorithm (Moriyaesque λ correction)

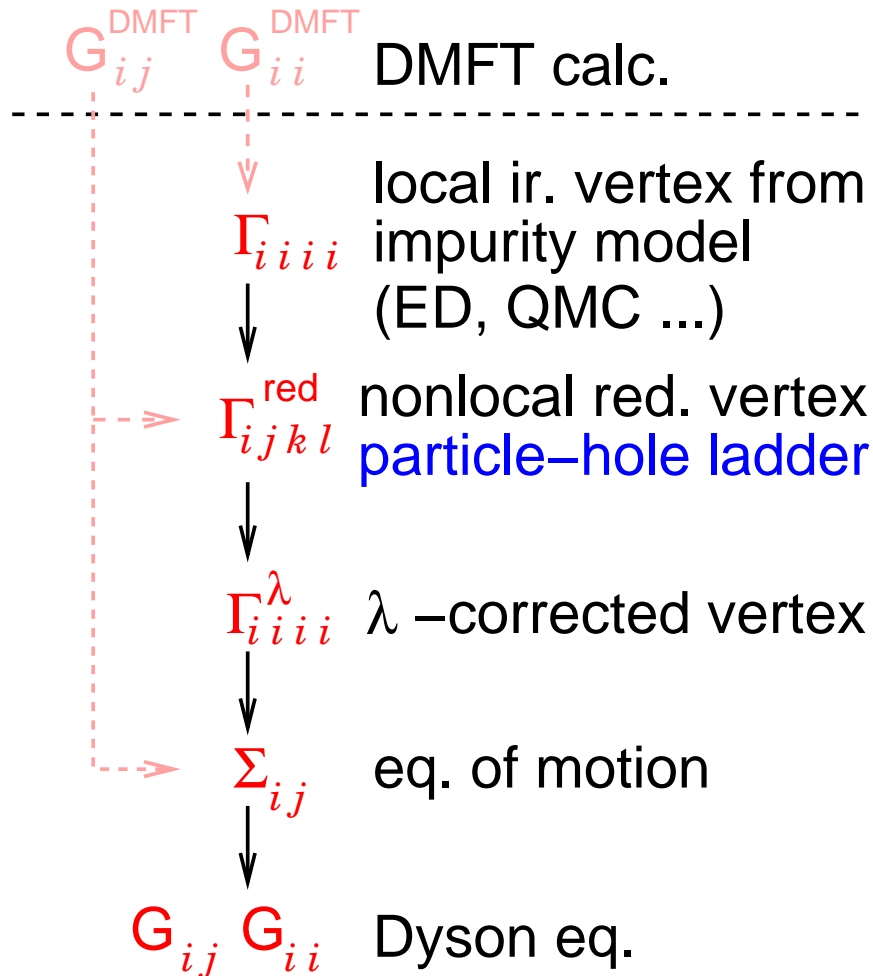

$$\chi_{q\omega}^s \longrightarrow \left[(\chi_{q\omega}^s)^{-1} + \lambda \right]^{-1}.$$

λ adjusted by sum rule:
$$- \int_{-\infty}^{\infty} \frac{d\nu}{\pi} \text{Im} \Sigma_{\mathbf{k},\nu} = U^2 n(1 - n/2)/2$$

Results: 3D Hubbard model without λ correction

$$H = -t \sum_{\langle i,j \rangle \sigma} c_{i\sigma}^\dagger c_{j\sigma} + U \sum_i n_{i\uparrow} n_{i\downarrow}$$

cubic lattice, exact diagonalization as impurity solver

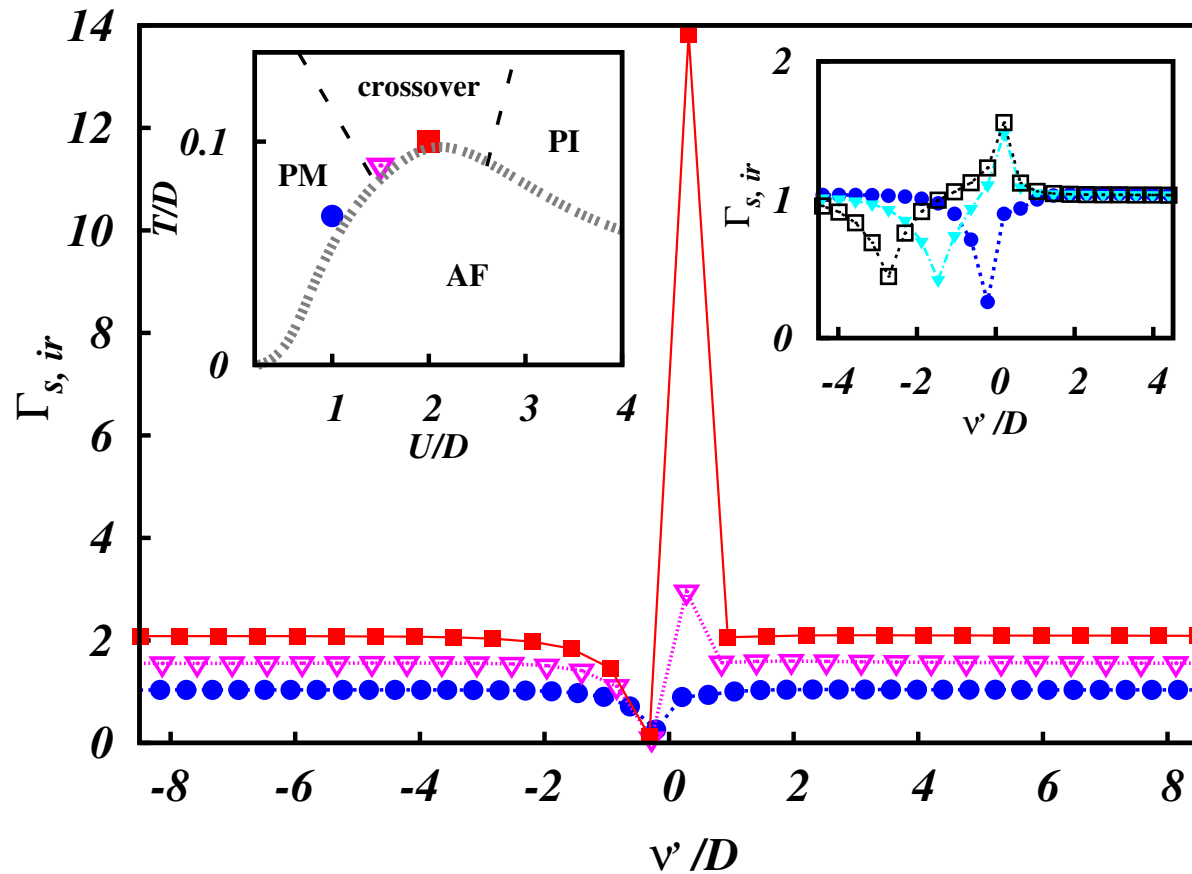

eff. bandwidth $\equiv 2D$
 $\omega = 0$
 $\nu = \pi T$

$\Gamma_{s,ir}(\nu, \nu', \omega)$ strongly frequency dependent

Results: 3D Hubbard model w/o λ correction

Σ and A for $\mathbf{k} = (\pi/2, \pi/2, \pi/2)$ (on Fermi surface)

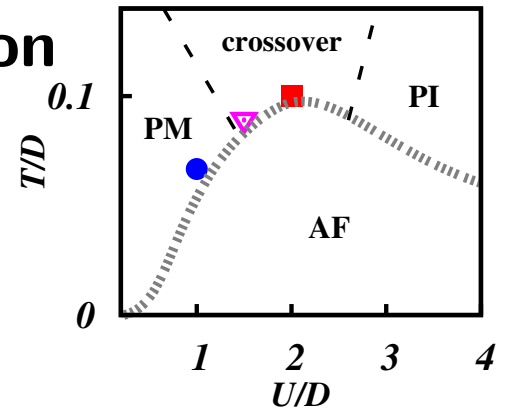

Results: 3D Hubbard model w/o λ correction

Σ and A for $\mathbf{k} = (\pi/2, \pi/2, \pi/2)$ (on Fermi surface)

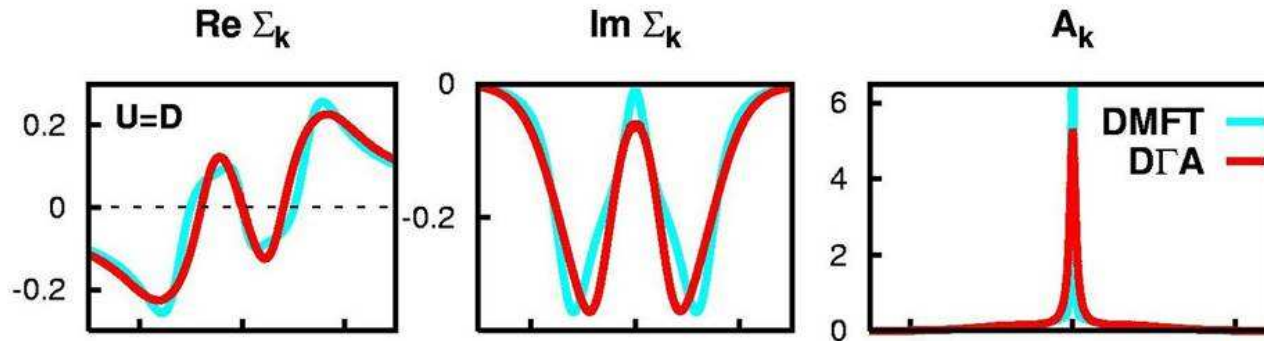
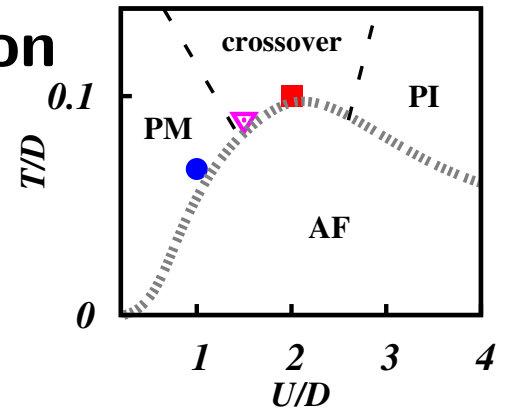

← weak damping of QP peak

Results: 3D Hubbard model w/o λ correction

Σ and A for $\mathbf{k} = (\pi/2, \pi/2, \pi/2)$ (on Fermi surface)

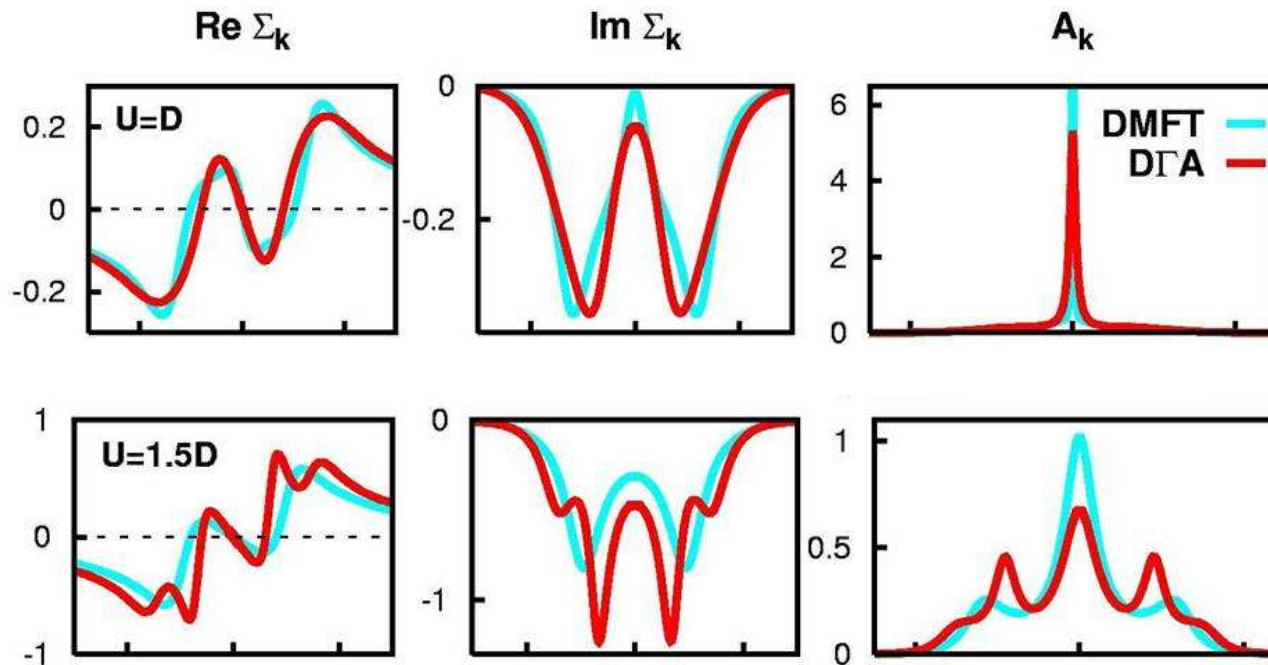
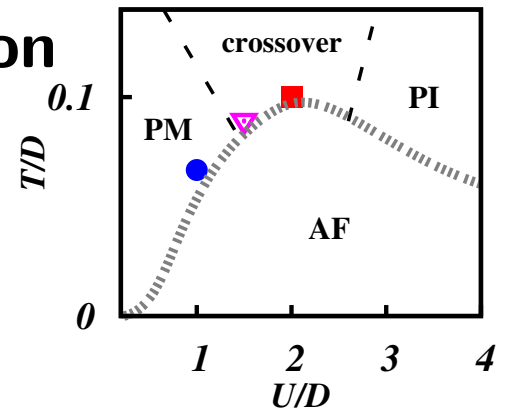

← weak damping of QP peak

← QP-damping strongly enhanced

Results: 3D Hubbard model w/o λ correction

Σ and A for $\mathbf{k} = (\pi/2, \pi/2, \pi/2)$ (on Fermi surface)

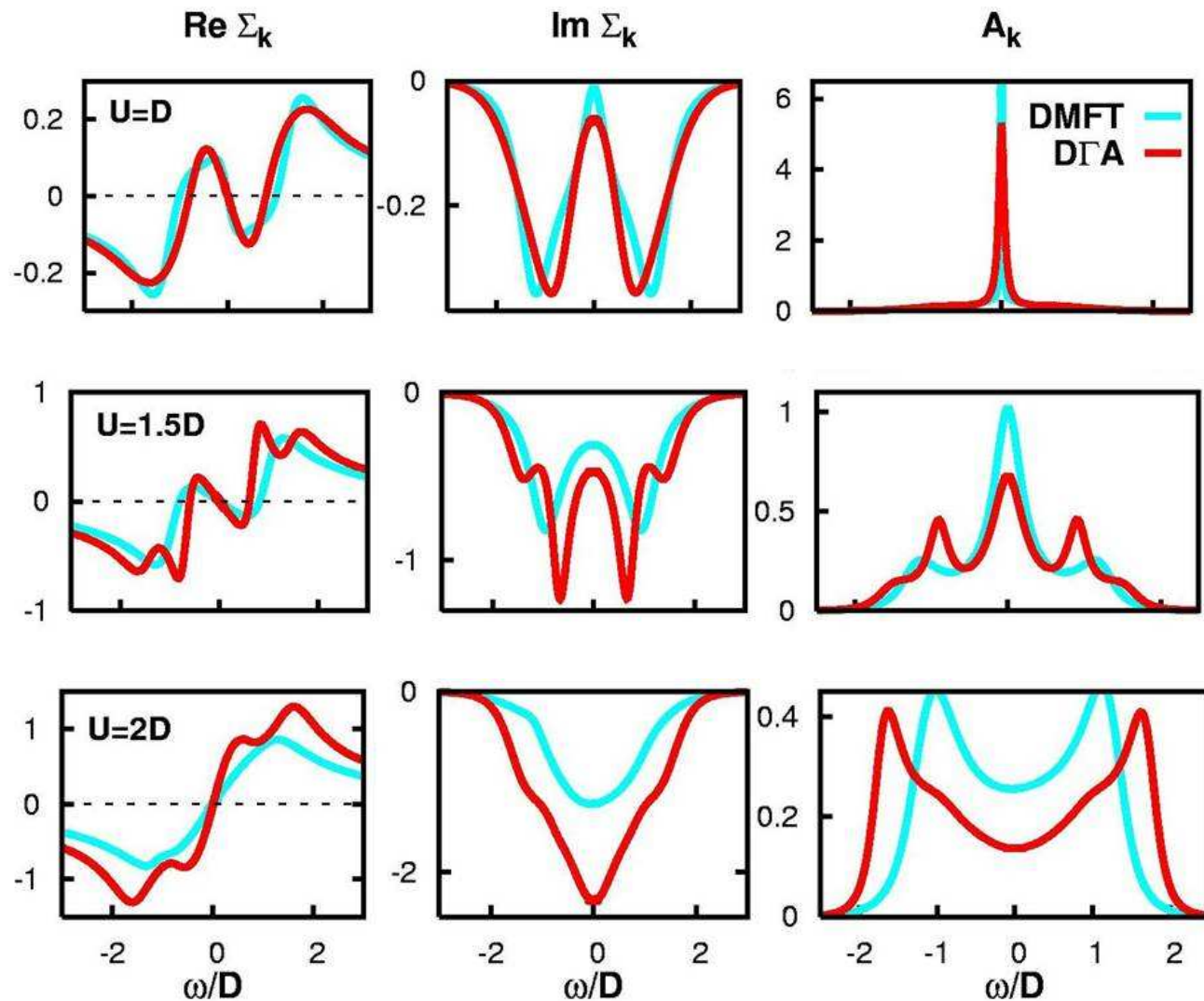
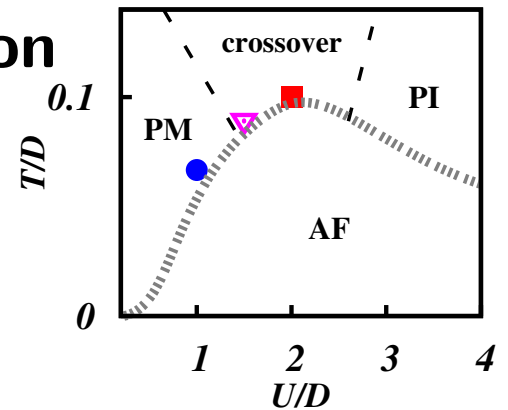

← weak damping of QP peak

← QP-damping strongly enhanced

← more insulating

Results: 3D Hubbard model with λ correction

Σ and A for $\mathbf{k} = (\pi/2, \pi/2, \pi/2)$ (on Fermi surface)

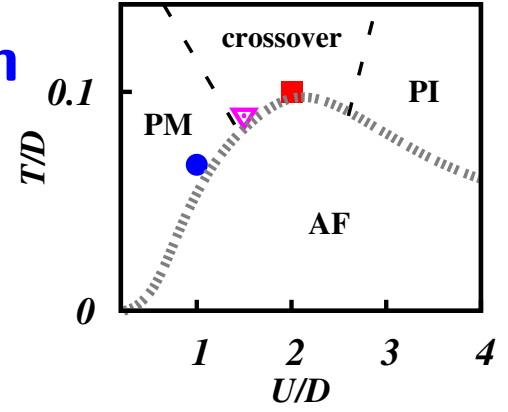

Results: 3D Hubbard model with λ correction

Σ and A for $\mathbf{k} = (\pi/2, \pi/2, \pi/2)$ (on Fermi surface)

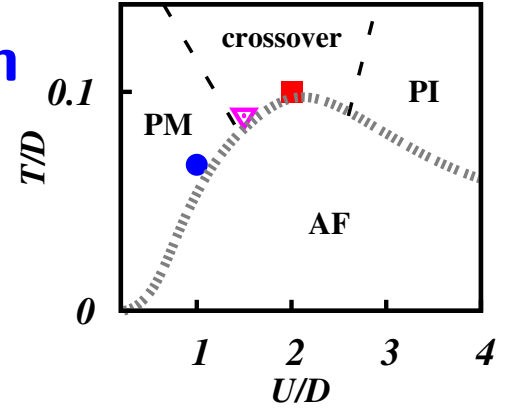

Comparison with/without λ correction

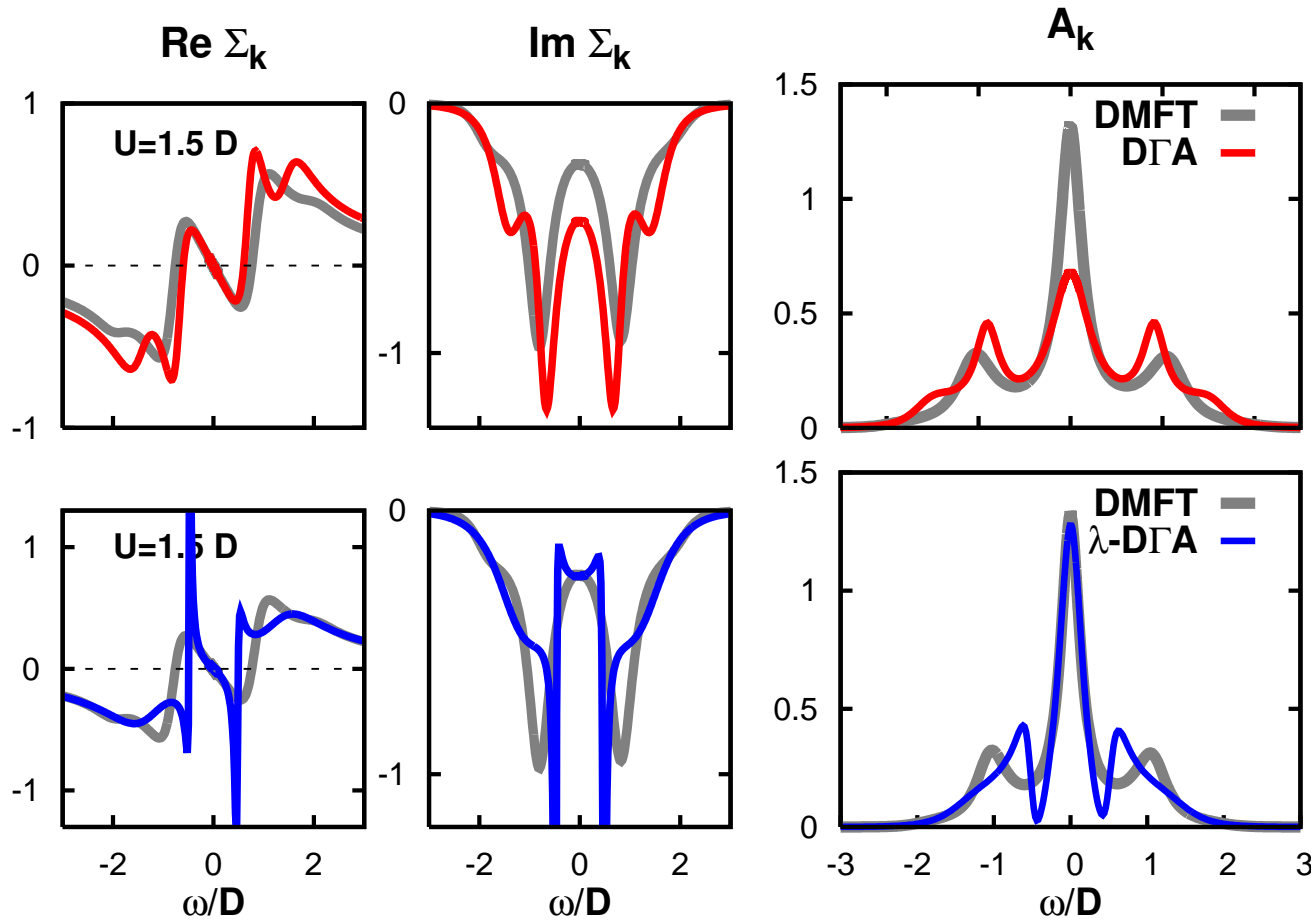

now far away from T_N ! ($T = 0.09$)

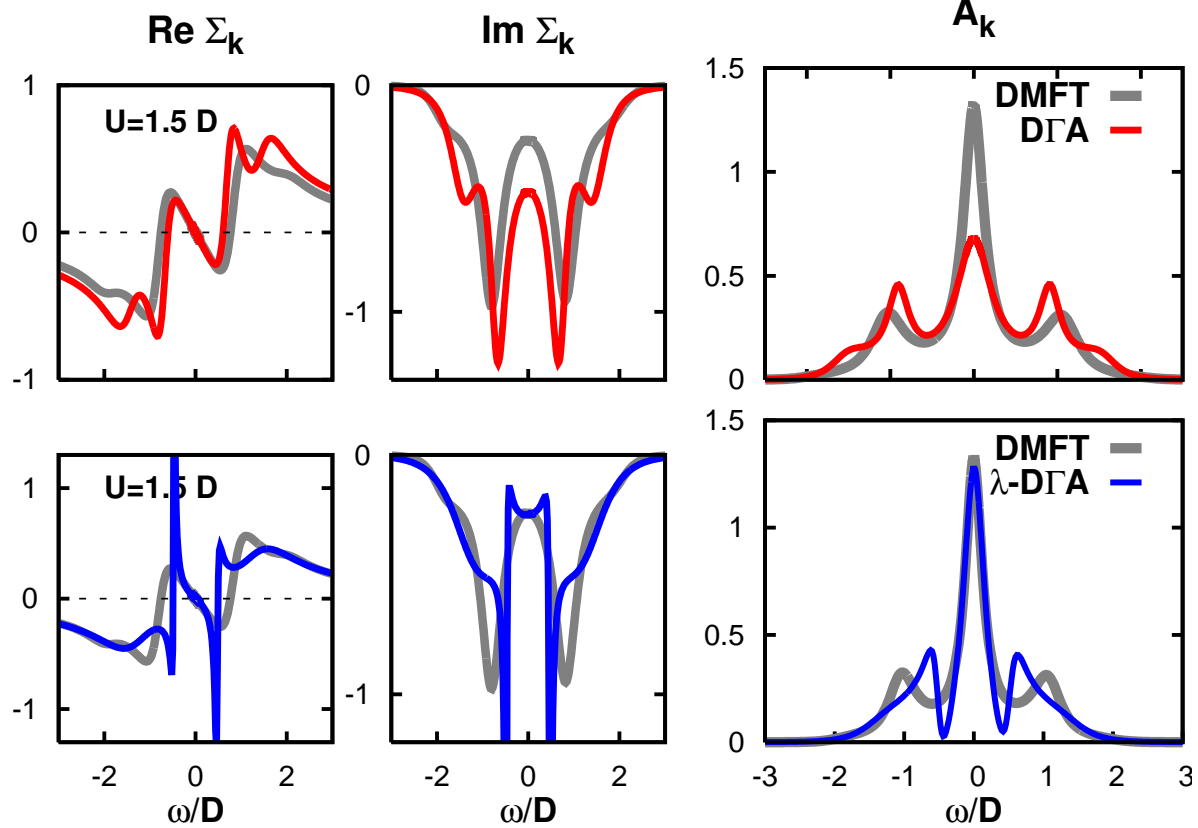

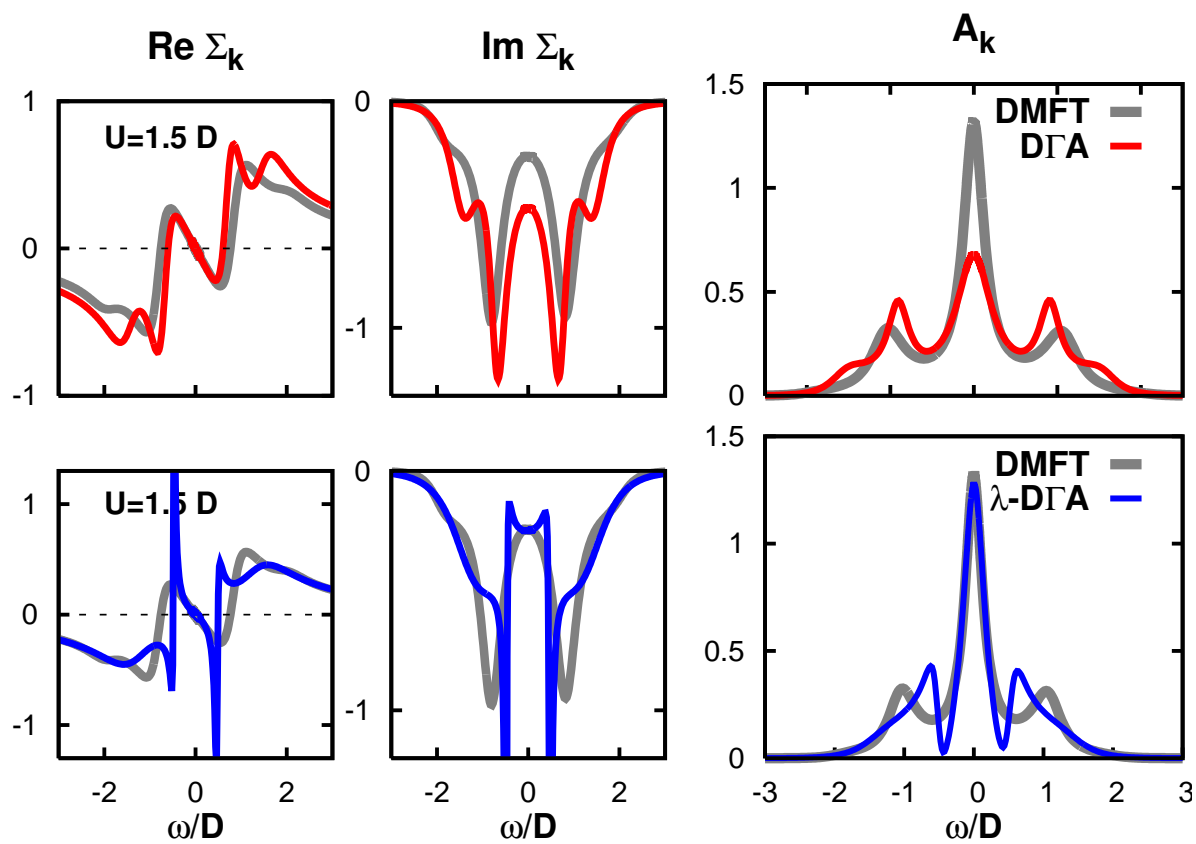

Reducing T towards T_N λ corrected T ($T = 0.067$)

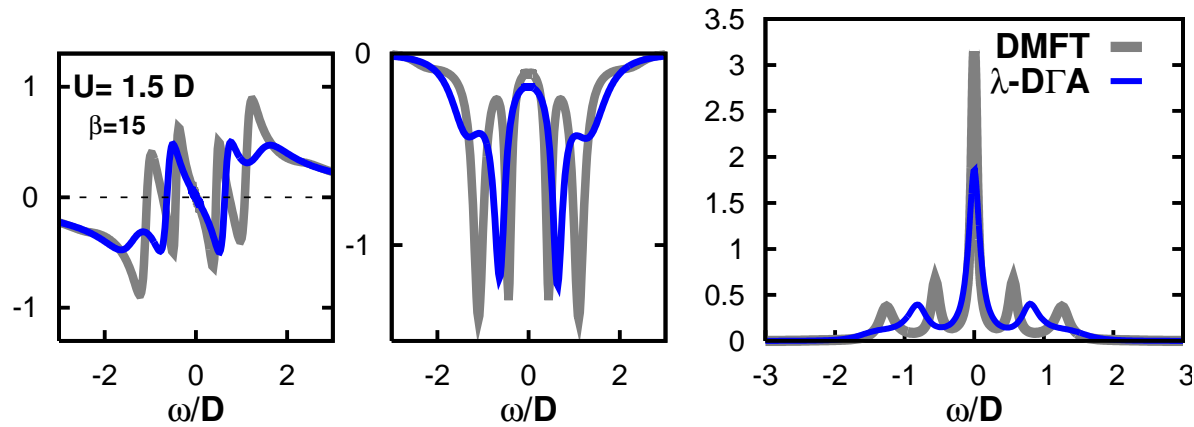

similar results as without λ correction but at a lower T

Results: 2D Hubbard model (half-filling)

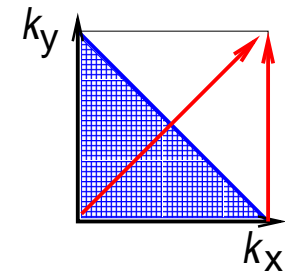

nodal
 $\mathbf{k} = (\frac{\pi}{2}, \frac{\pi}{2})$

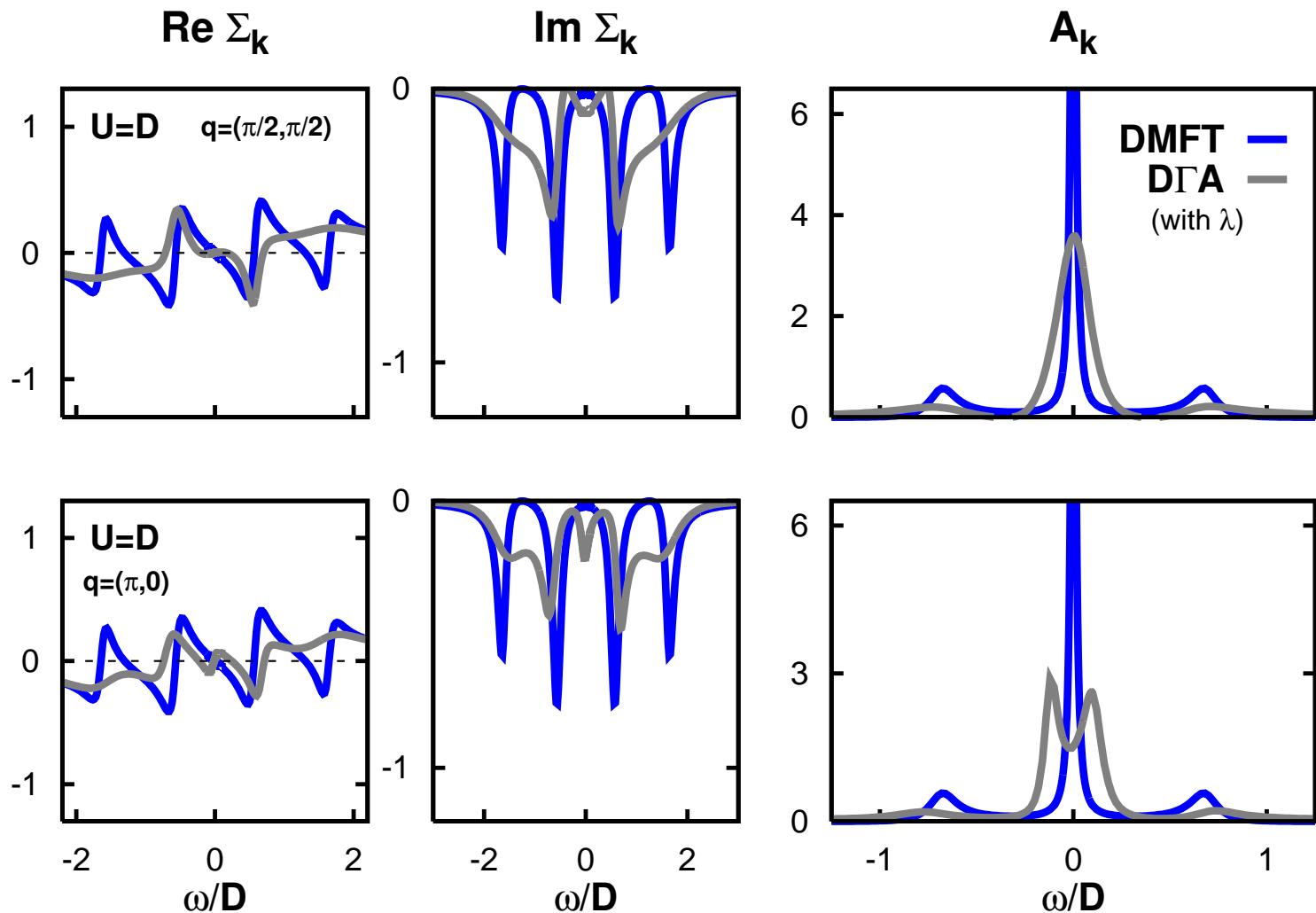

anti-nodal
 $\mathbf{k} = (\pi, 0)$

anisotropic pseudogap

Results: 2D Hubbard model (half-filling)

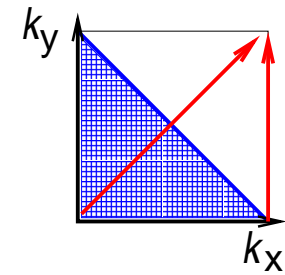

nodal

antinodal

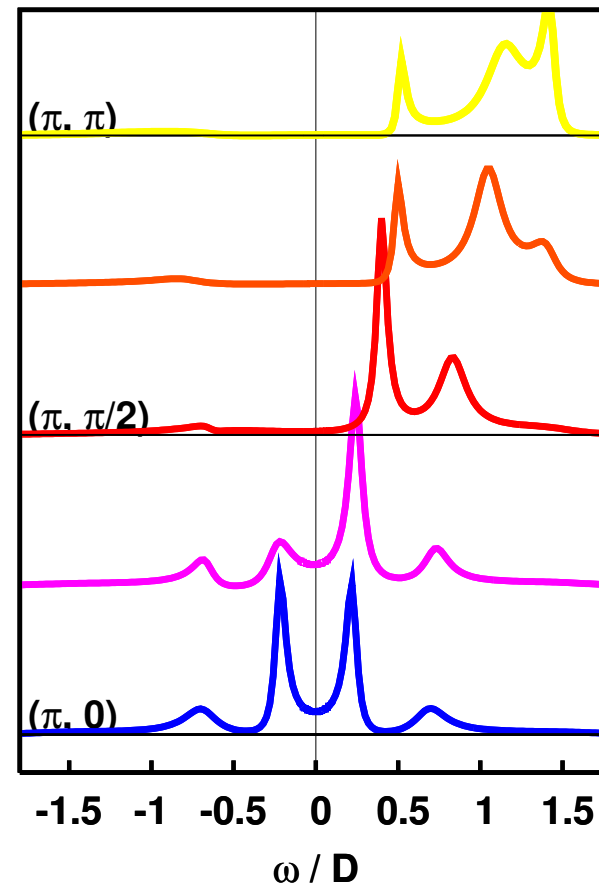
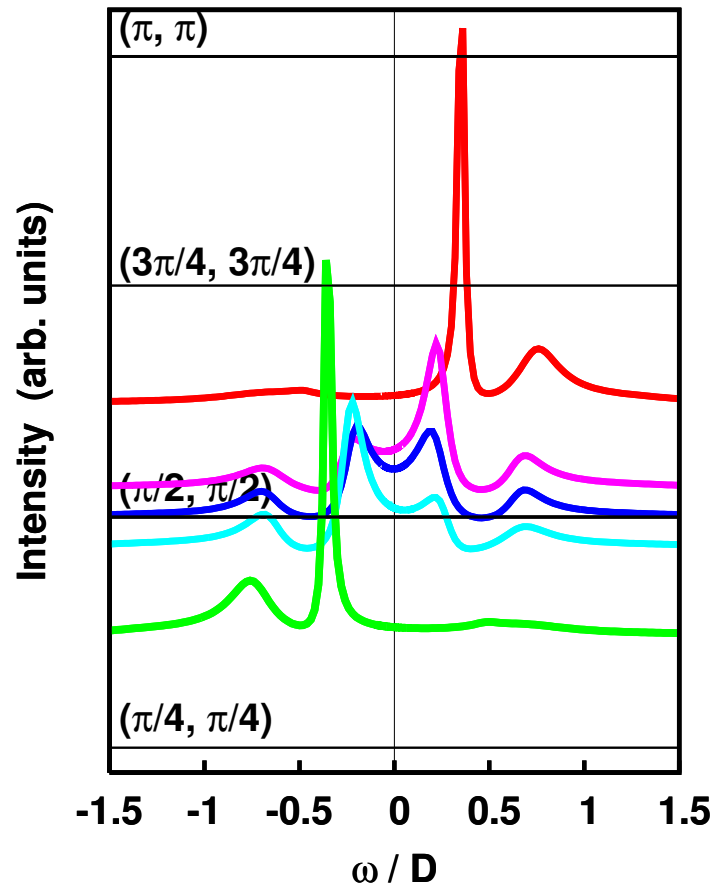

$$U = D, \beta = 16$$

Results: 2D Hubbard model (off half-filling)

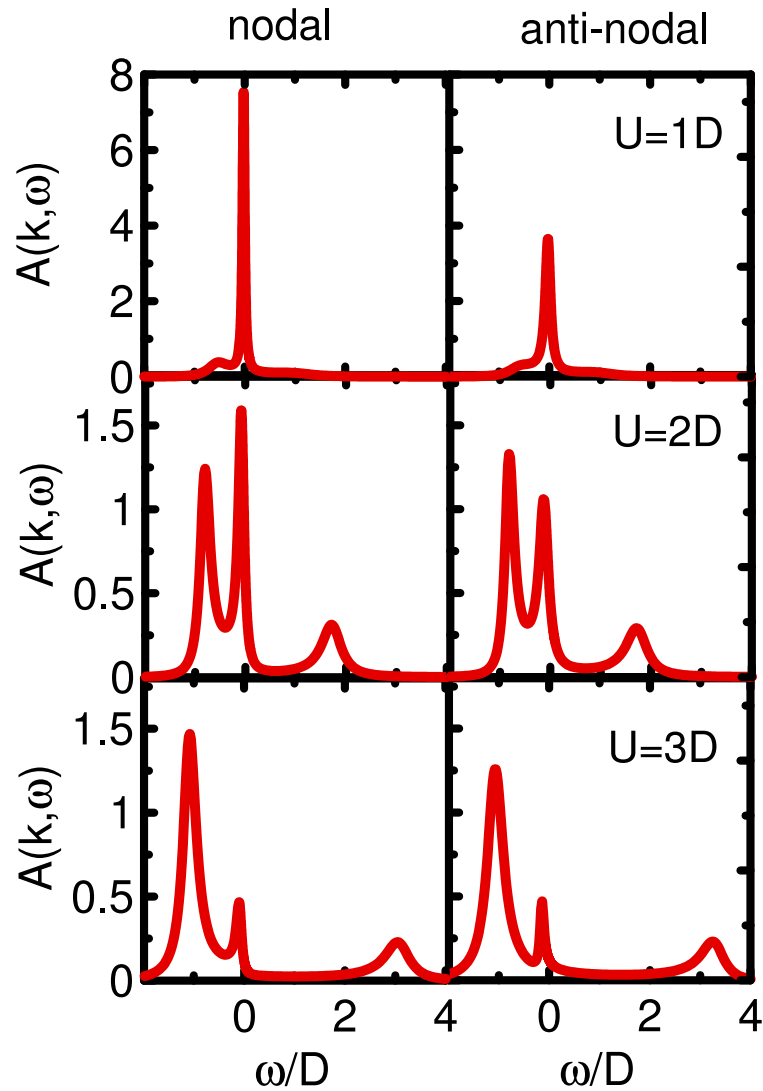

$$t'/t = 0.3$$

$$n = 0.8$$

$$\beta = 100/D$$

less anisotropic
at strong coupling

Critical exponents

Toschi, Katanin, KH '09

Antiferromagnetic phase transition in half-filled Hubbard model

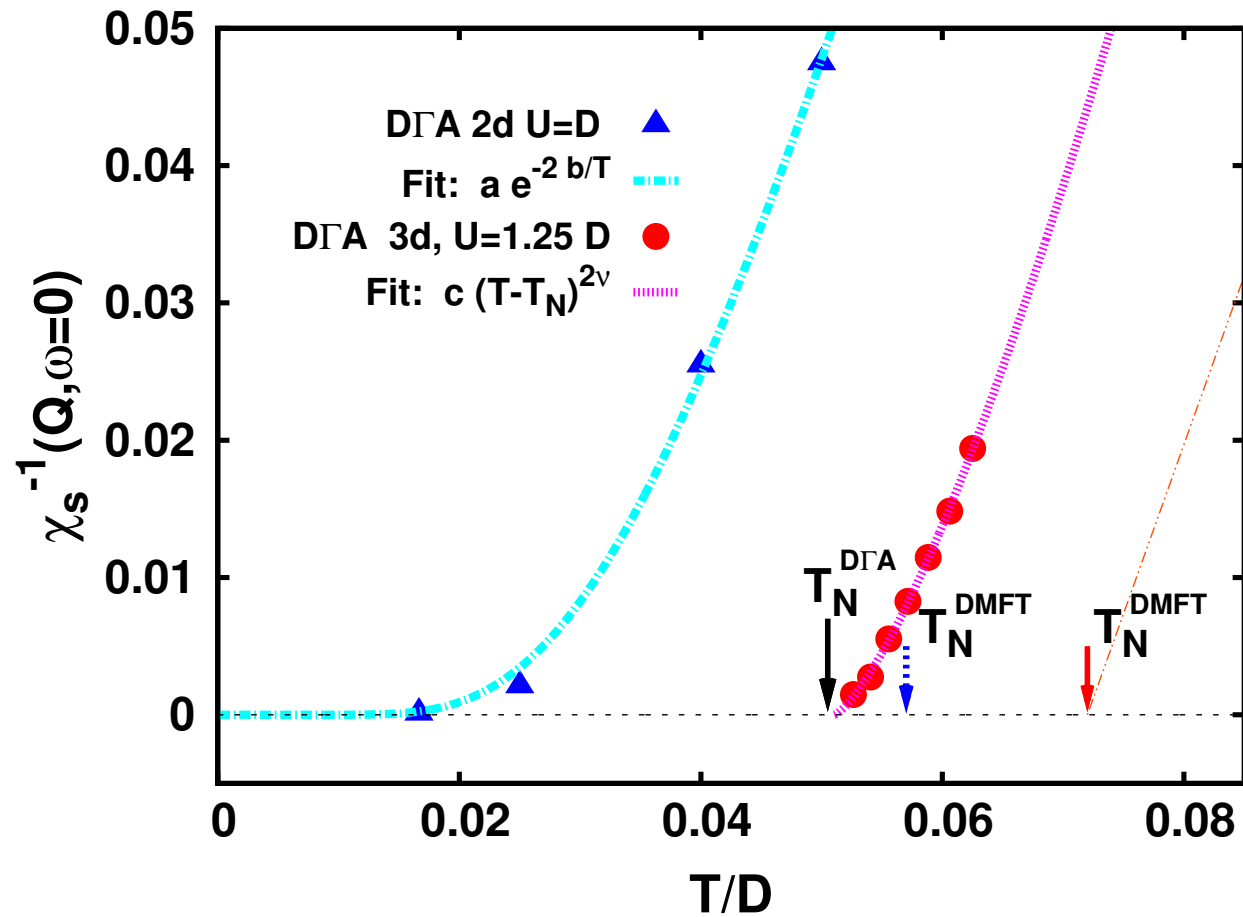

Critical exponents

Toschi, Katanin, KH '09

Antiferromagnetic phase transition in half-filled Hubbard model

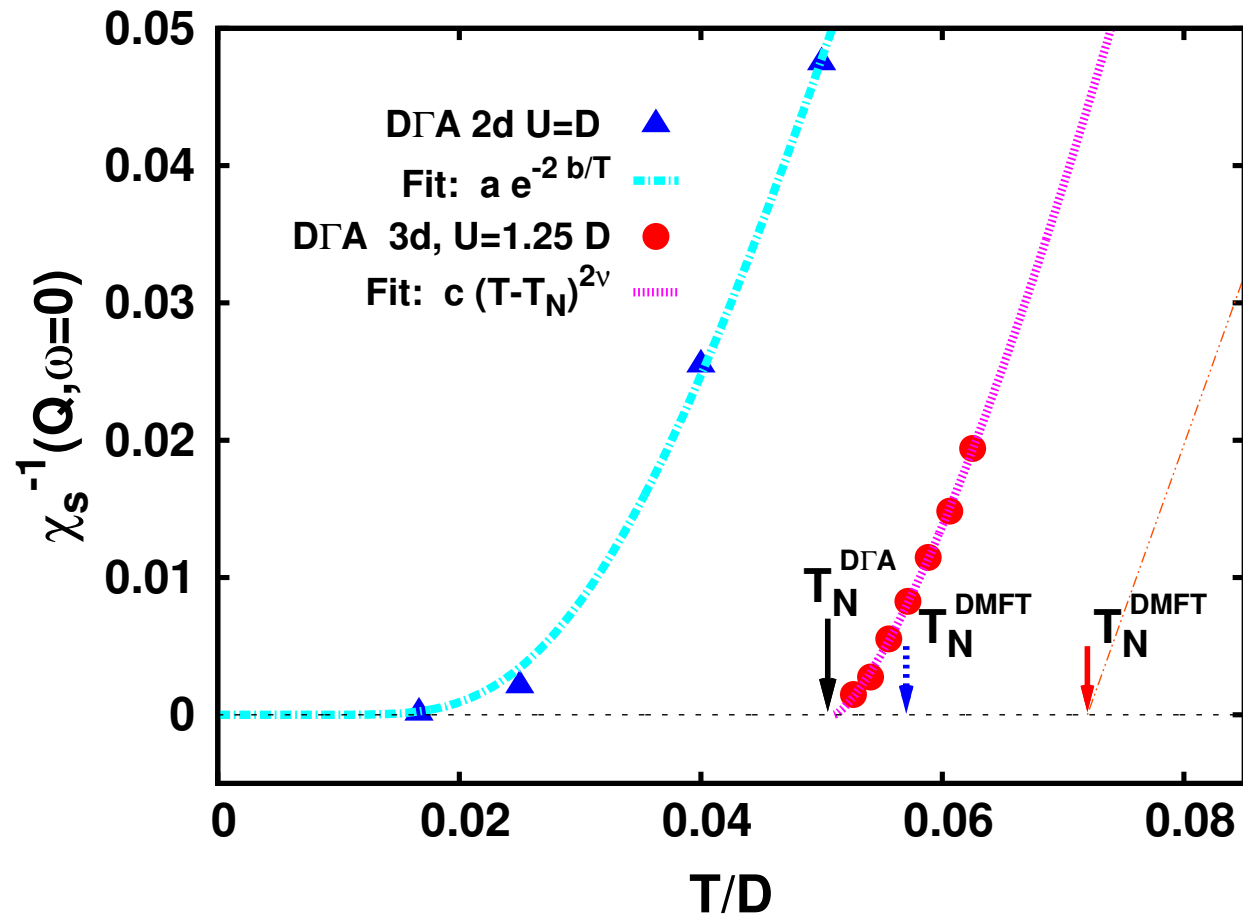

2D: Mermin-Wagner theorem fulfilled!

Critical exponents

Toschi, Katanin, KH '09

Antiferromagnetic phase transition in half-filled Hubbard model

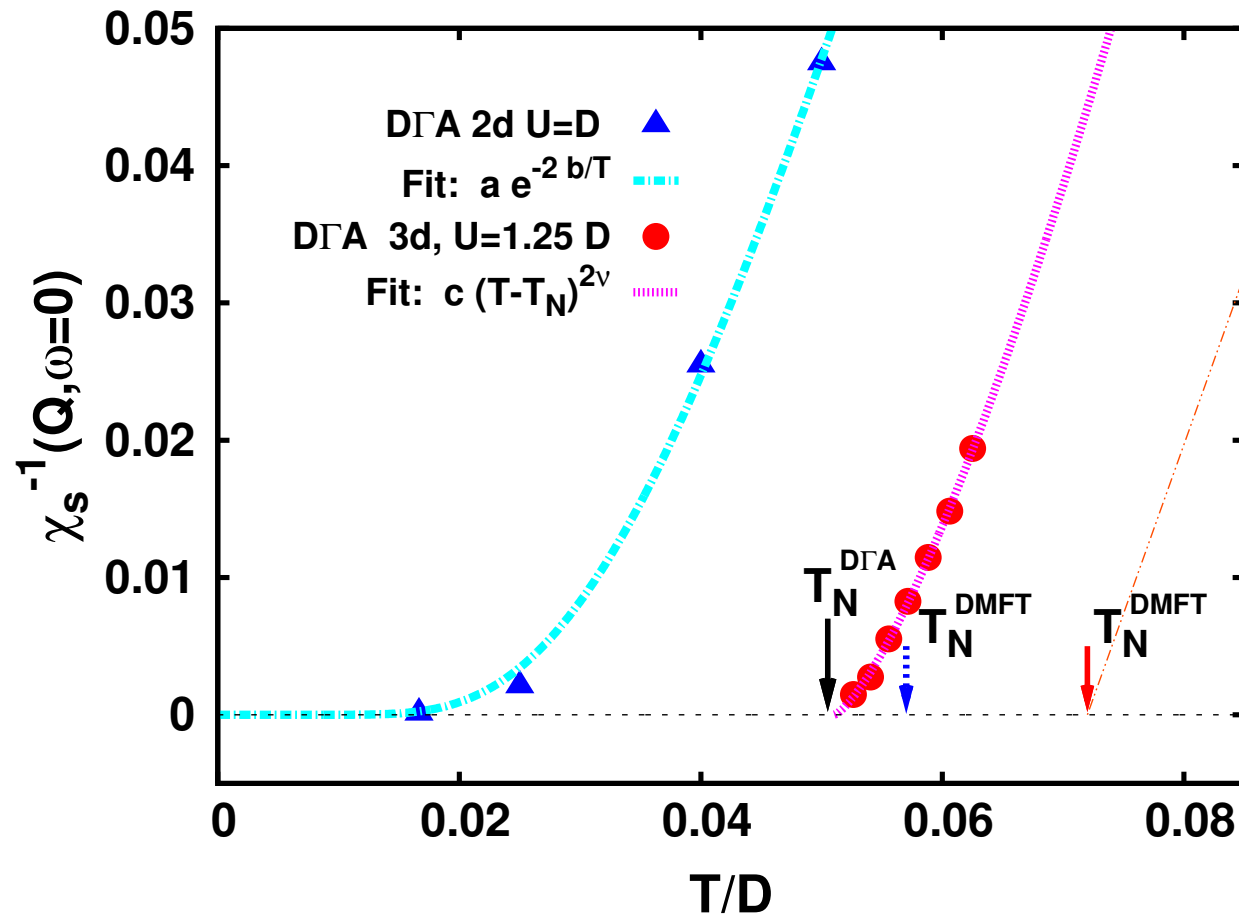

2D: Mermin-Wagner theorem fulfilled!

3D: critical exponent $\nu = 0.67 \pm 0.05$ agrees with Heisenberg model $\nu = 0.707...$

Critical exponents

Toschi, Katanin, KH '09

Logarithmic plot

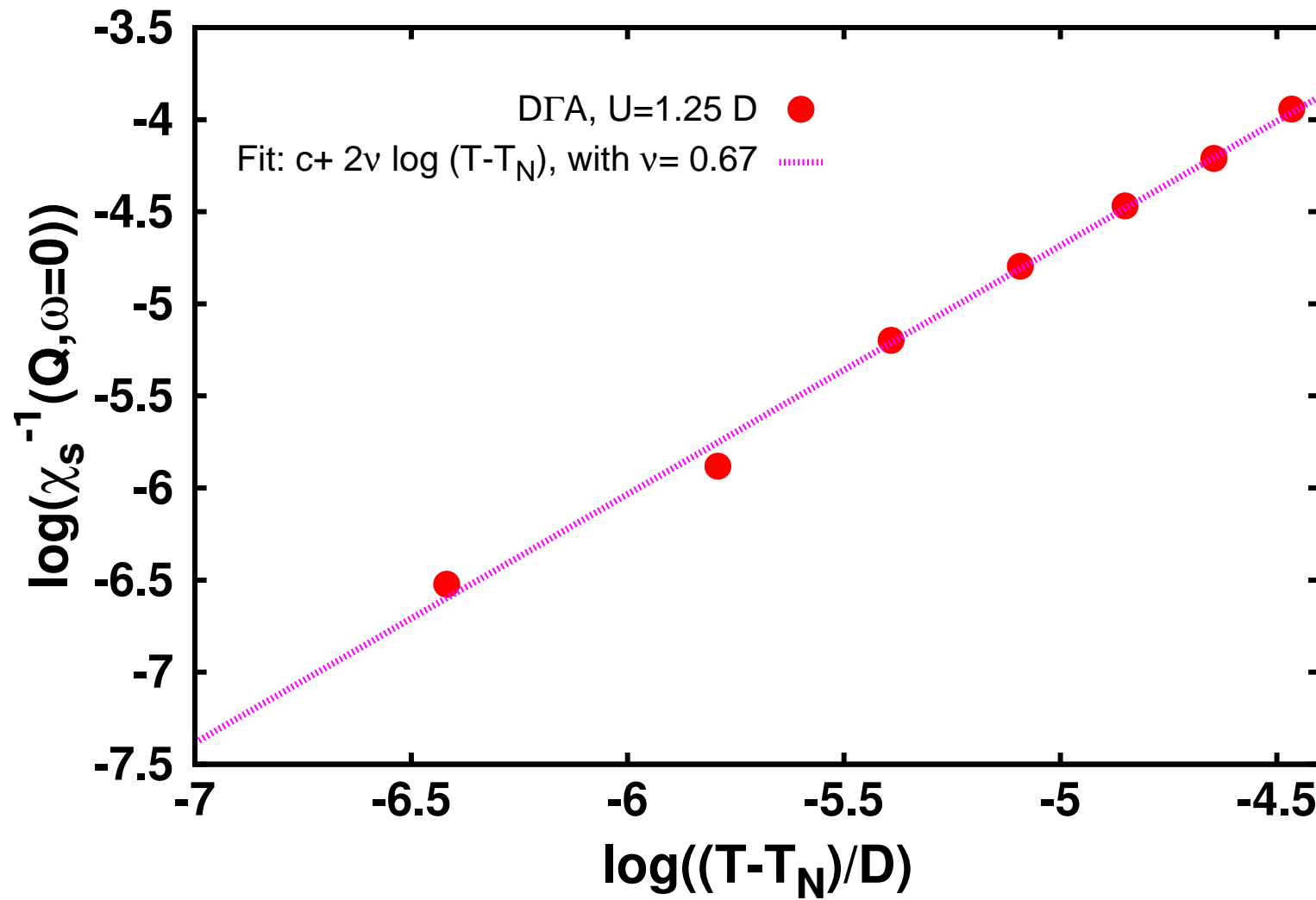

Phase diagram

Toschi, Katanin, KH '09

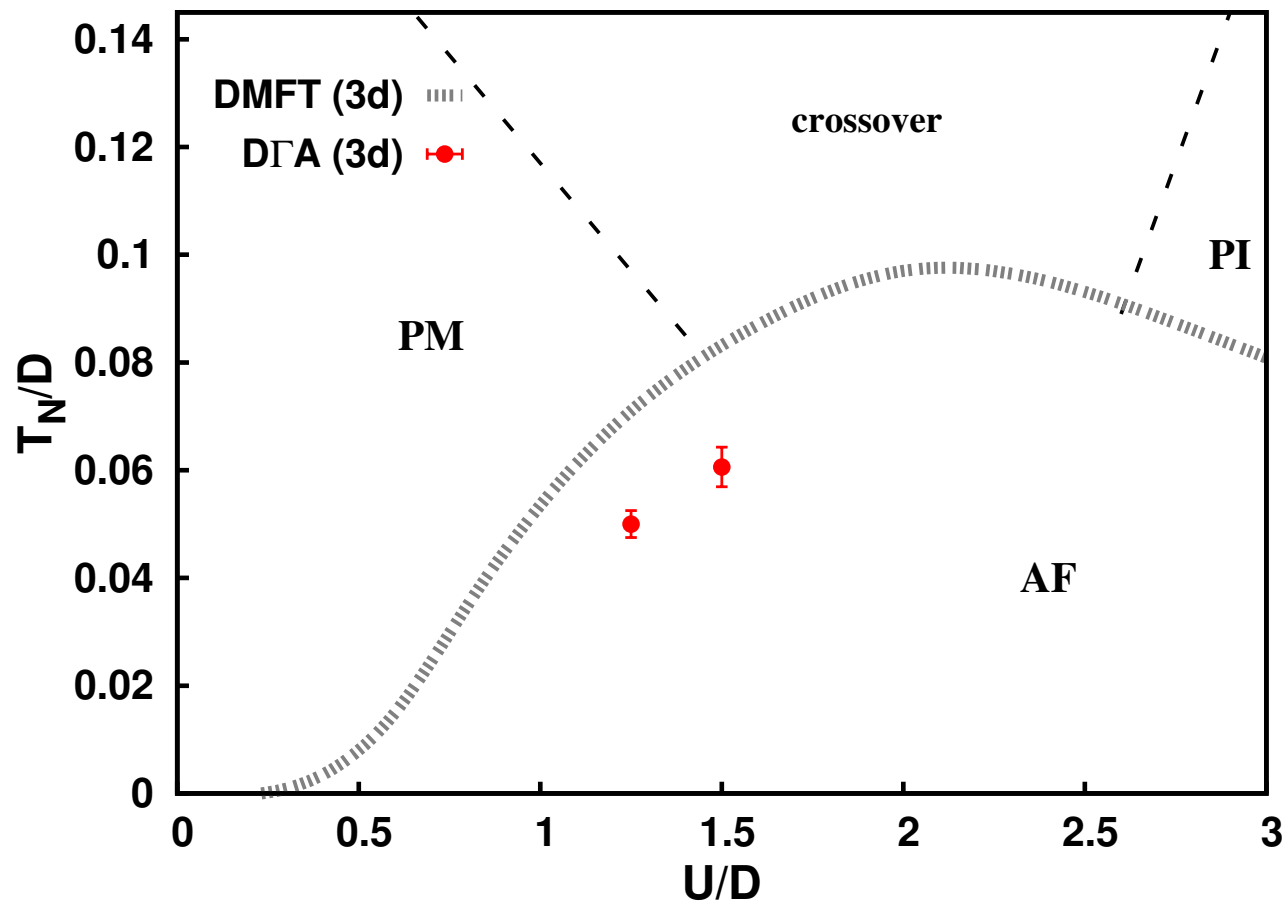

3D: reduction of T_N very reasonable
2D: $T_N = 0$

Conclusion

- **DΓA** assumption: **local** 2-particle irreducible Γ

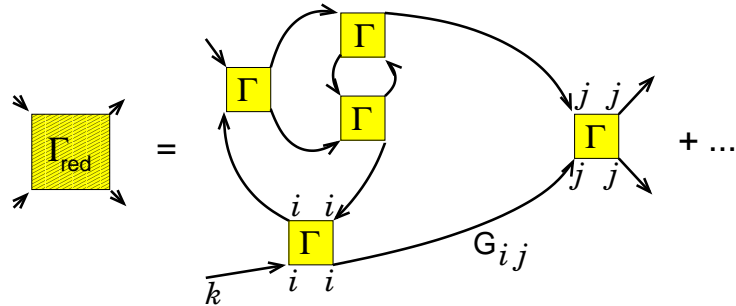

- **DΓA** can access **short-** and **long-range** correlations
- Results: 3D: **Mott-Hubbard transition** modified by **AF fluctuations**
3D: critical exponent $\nu \approx 0.7$
2D: **pseudogap**
2D: **Mermin Wagner** fulfilled

Outlook

- Physics: **magnons**, interplay between **AFM and superconductivity**, **QCP**
- Realistic **multi-orbital** calculations possible with **LDA+DΓA**