

Controlling electrons for ultrafast molecular imaging

Ricardo Torres
Imperial College London, UK

KITP, Santa Barbara, May 2009

Strong laser field interaction with molecules

Laser intensity $\sim 100 \text{ TW/cm}^2$

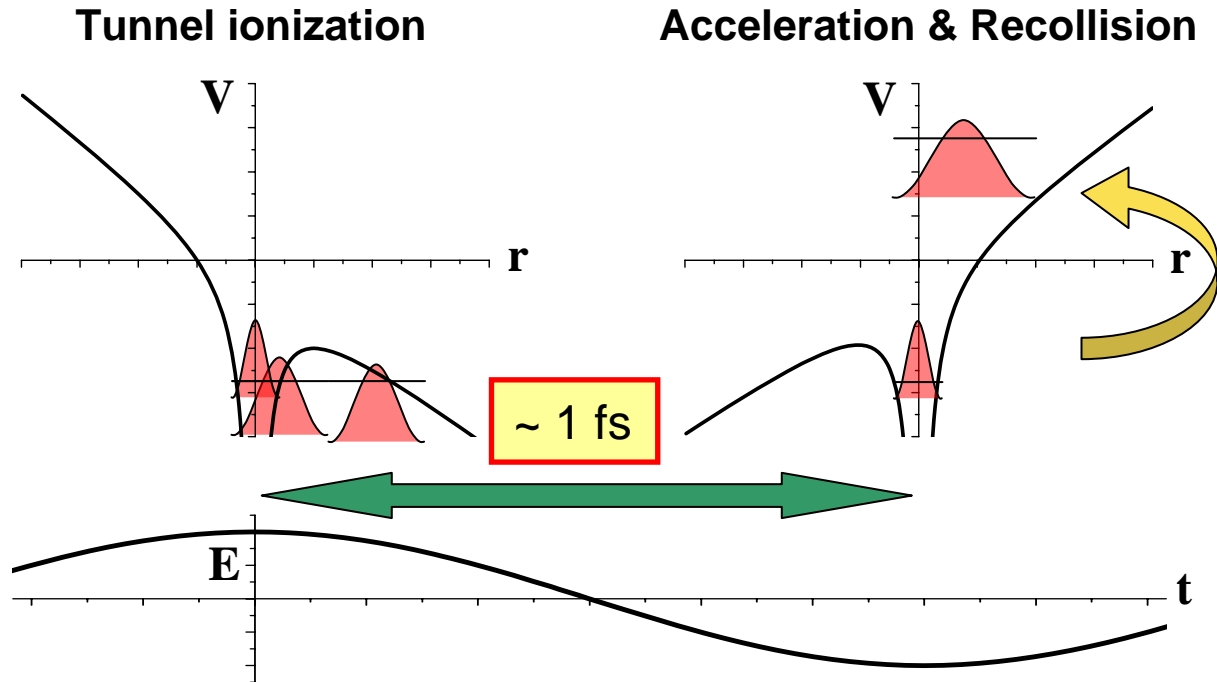

e^- kinetic energy
 $\sim 100 \text{ eV}$

e^- current density
 $> 10^{10} \text{ A/cm}^2$

P.B. Corkum, Phys. Rev. Lett. 71, 1994 (1993)

Laser driven electrons can be used to probe molecular structure:

- **Sub-fs time resolution.**
- **Sub-Angstrom spatial resolution**
- **Broad energy spectrum**

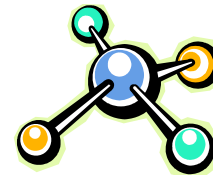

Laser induced electron diffraction

The angular distribution of rescattered electrons may exhibit **diffraction peaks/minima**; a signature of the molecular internuclear separation.

T. Zuo *et al.*, Chem. Phys. Lett. 259, 313 (1996).

M. Lein *et al.*, Phys. Rev. A 66, 051404 (2002).

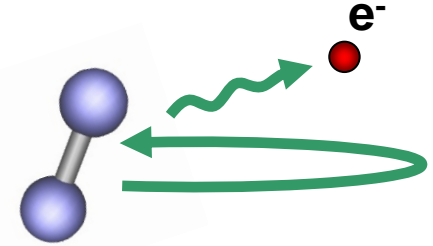

Best information found at **high electron energies**.

Measuring angular distribution of such high energy electrons is **experimentally difficult**.

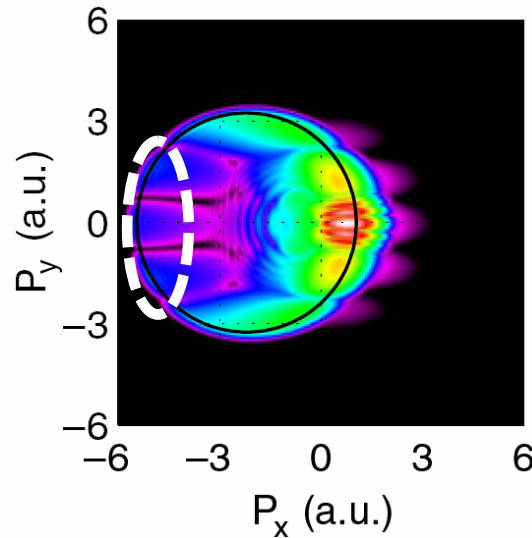

5-6 a.u: 340-490 eV
(Up ~ 42eV)

M. Spanner *et al.*,
J. Phys. B 37, L243 (2004).

Recent experimental demonstration of laser induced electron diffraction in N_2 and O_2 using COLTRIMS with electrons up to ~ 100 eV.

M. Meckel, *et al.* Science 320, 1478 (2008).

Laser induced electron diffraction

Development of a Velocity Map Imaging Spectrometer for measurement of velocity distribution of electrons up to 300 eV.

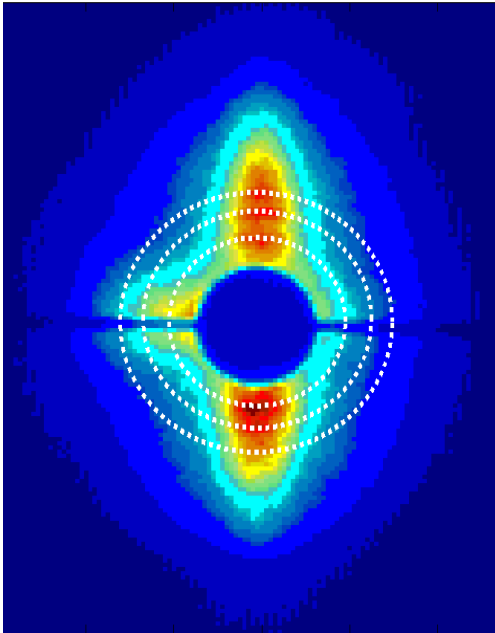

Energy distribution along polarization direction

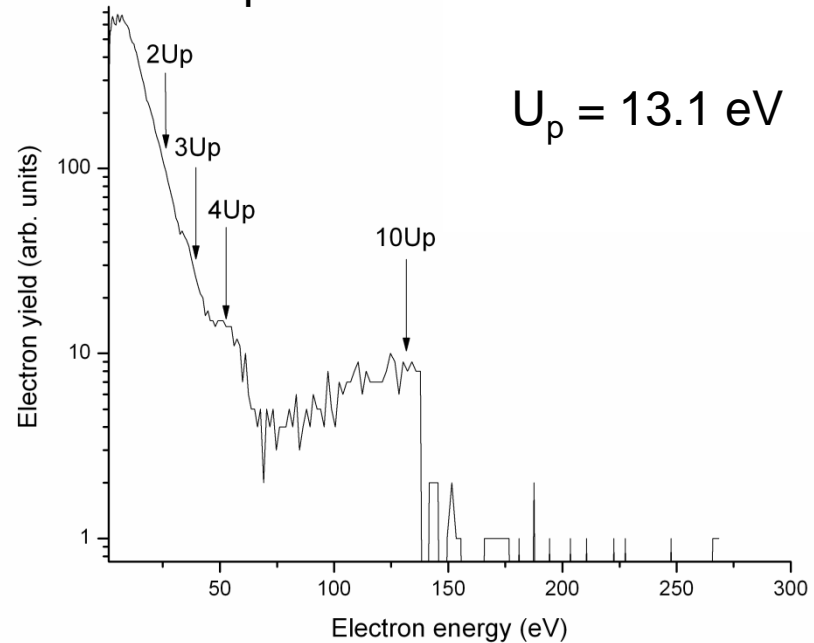

Maximum energy electron detected $\sim 140 \text{ eV}$ – but limited by laser intensity, not performance of VMI spectrometer.

High order harmonic generation (HHG)

The recolliding electron wavepacket can be reabsorbed into the initial state emitting light in the form of harmonics of the fundamental laser frequency.

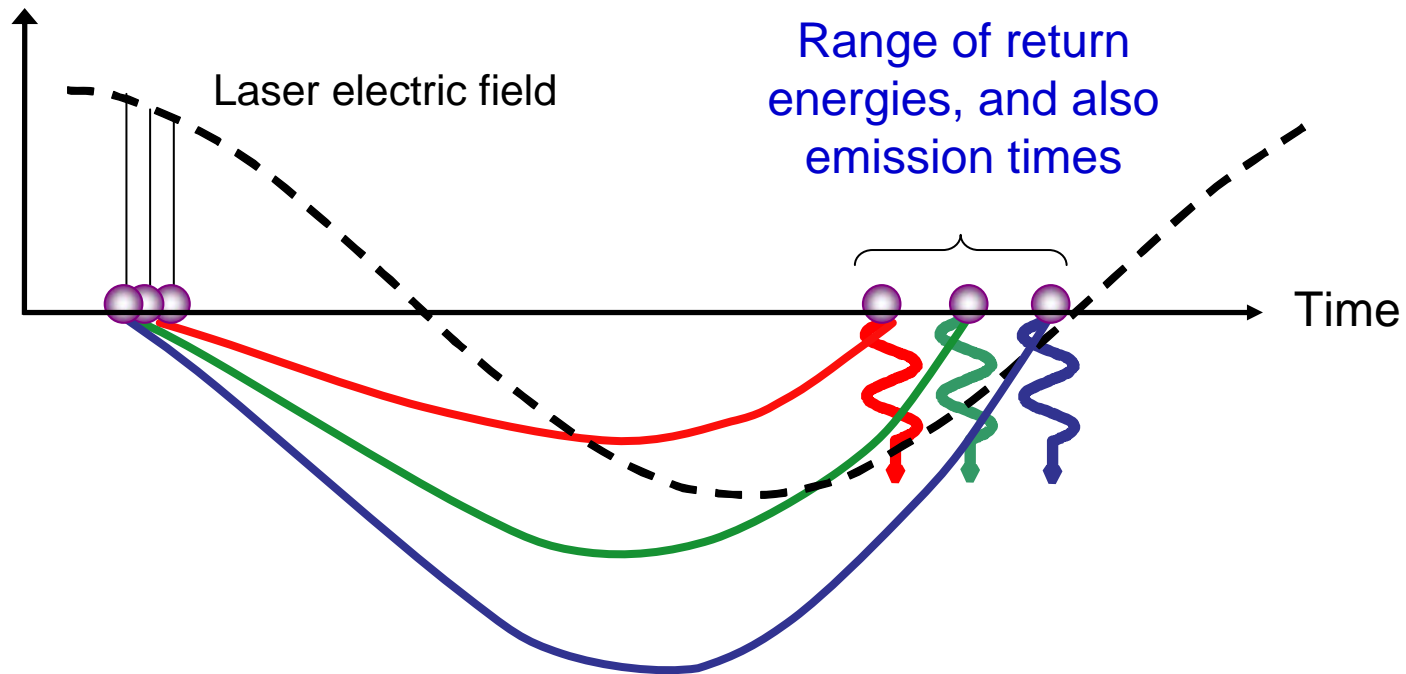

Structural information of the molecule **measured by the electrons** is **transferred to XUV light**.

Each harmonic carries information about a different “slice” of the molecule in momentum space and a different time.

Theoretical description of HHG

Harmonic spectrum is caused by the oscillation of the dipole moment arising from the overlap of the continuum wavefunction with the bound state.

$$\mathbf{D}(t) = \langle \psi_0 | \mathbf{r} | \psi_C \rangle$$

Bound state Continuum wavefunction

Strong Field Approximation (SFA) is useful to describe HHG in molecules.

- Continuum states are approximated as **plane waves**.

$$\psi_C(\mathbf{r}) = \int a(\mathbf{k}) e^{i\mathbf{k}\cdot\mathbf{r}} d\mathbf{k}$$

- Ignores influence of laser field upon molecular bound state. Usually assumes single-active electron, therefore the bound state ψ_0 is a **molecular orbital**.

$$\mathbf{D}(t) \sim \mathcal{F}[\mathbf{r}\psi_0]$$

We can go beyond SFA but it is a convenient framework with which to begin

Controlling HHG

We want to control the measurements by manipulating:

- 1) Target (Fixing molecular alignment in space).
- 2) Probe (Steering the electrons with the electric field).

Molecular alignment

Non-resonant, linearly polarized laser field ($I \sim 10^{13}$ W/cm², $\tau < 100$ fs) produces a **wavepacket of rotational states** localizing the molecular axis around the laser field axis.

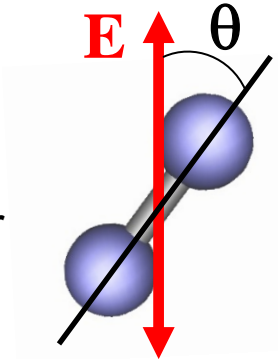

$$|J_i M\rangle \Rightarrow \sum_J C_{JiJ} |J M\rangle$$

Transient aligned states revive periodically every $\Delta t = T_{\text{rot}}/2$.

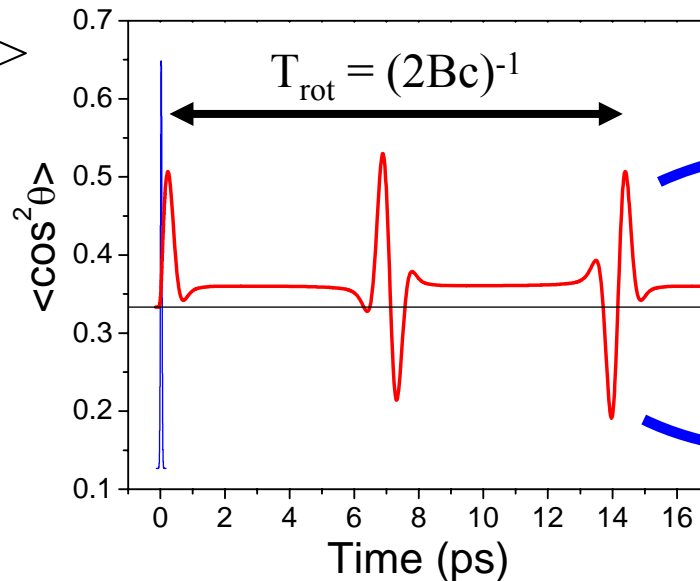

Alignment

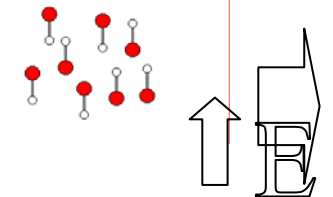

Anti-Alignment

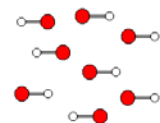

HHG in aligned CO₂

Experimental setup

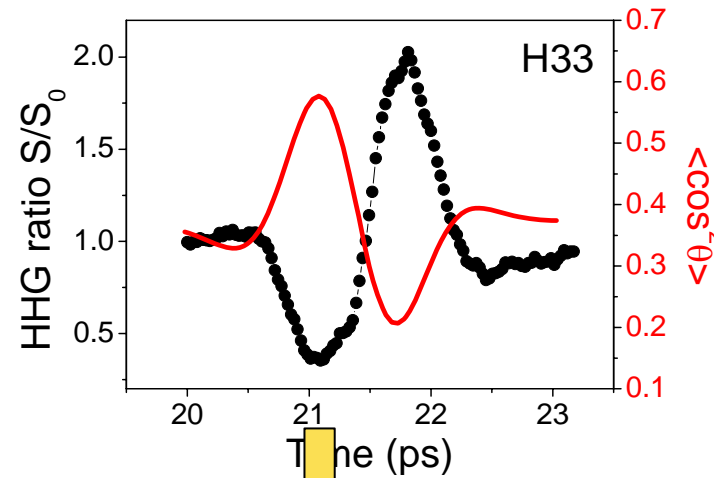
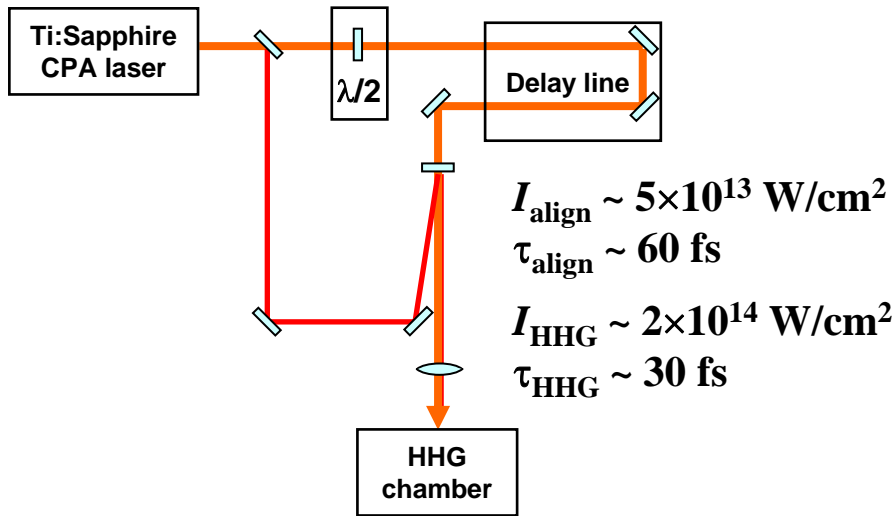

Two-center interference

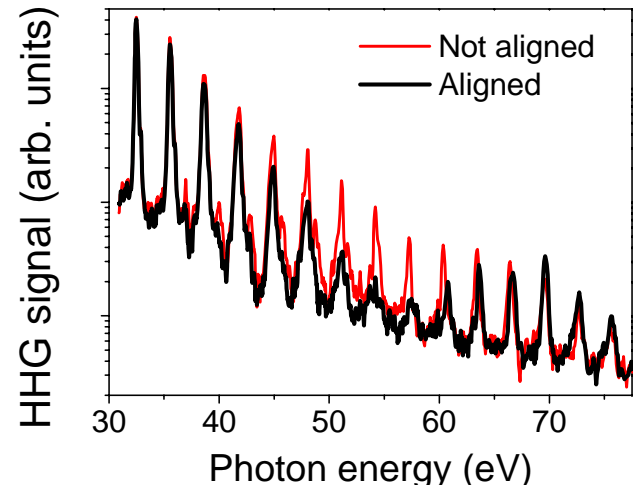
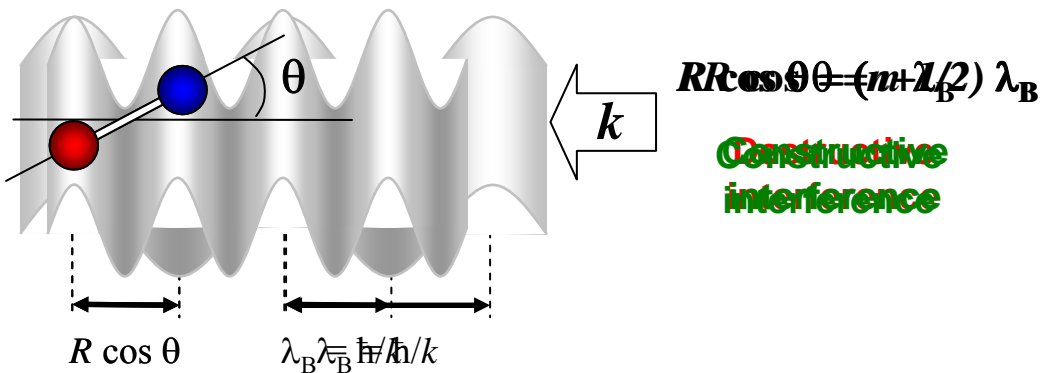

Tomographic reconstruction of orbitals

The dependence of HHG on molecular orientation also carries information about the electronic orbital structure.

Tomographic reconstruction

N_2

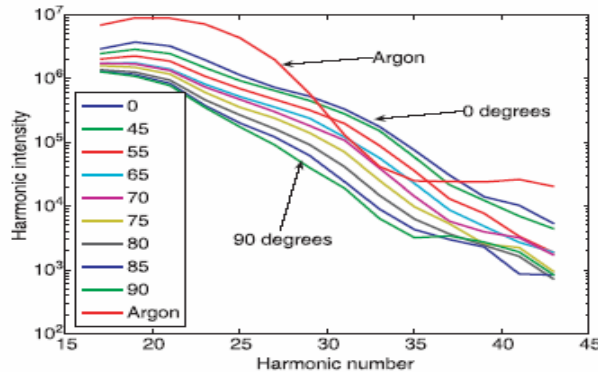
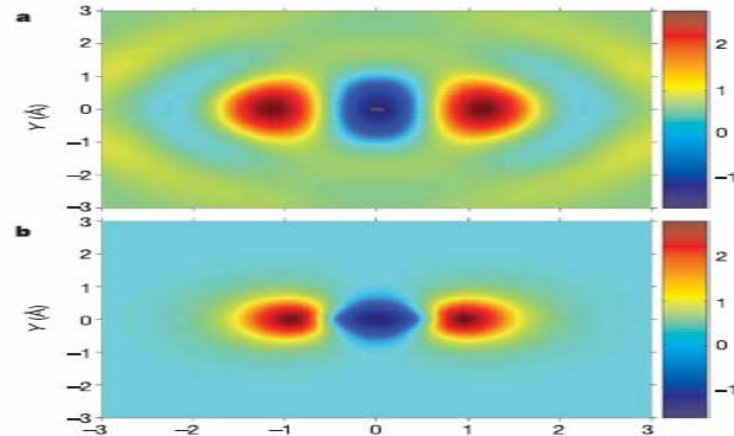

Figure 3 High harmonic spectra were recorded for N_2 molecules aligned at 19 different angles between 0 and 90° relative to the polarization axis of the laser. For clarity, only some of the angles have been plotted above. The high harmonic spectrum from argon is also shown; argon is used as the reference atom. Clearly the spectra depend on both the alignment angle and shape of the molecular orbital.



- Reconstructed orbital is HOMO + contribution from lower lying orbitals.
- Tomographic retrieval relies on validity of SFA – this must be checked!
- Only been demonstrated in N_2 so far.

J. Itatani *et al.*, Nature 432, 867 (2004)

S. Patchkovskii *et al.*, Phys. Rev. Lett. 97, 123003 (2006)

HHG in aligned polyatomics

C₂H₂ (Acetylene)

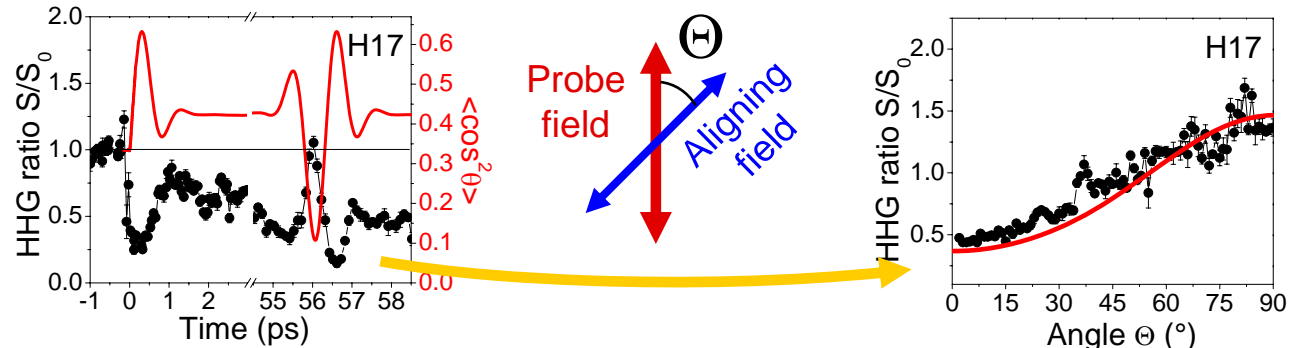
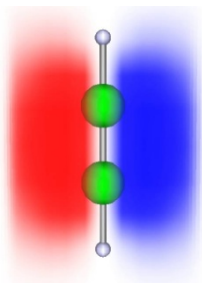

C₂H₄ (Ethylene)

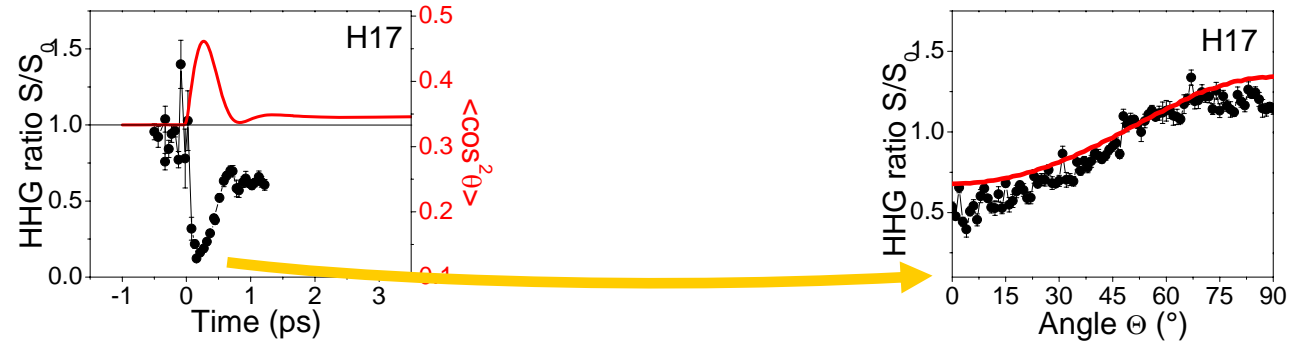
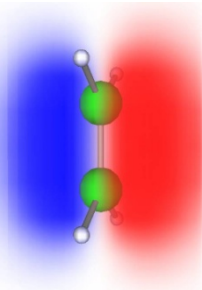

C₃H₄ (Allene)

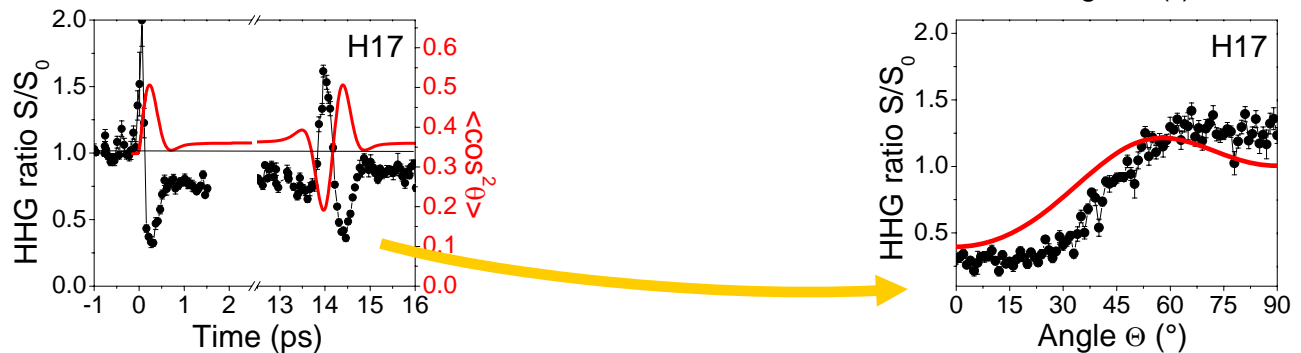
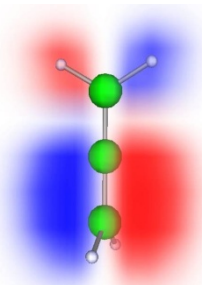

Harmonic signal maps out the HOMO structure

R. Torres *et al.*,
Phys. Rev. Lett. 98, 203007 (2007)

Some limitations

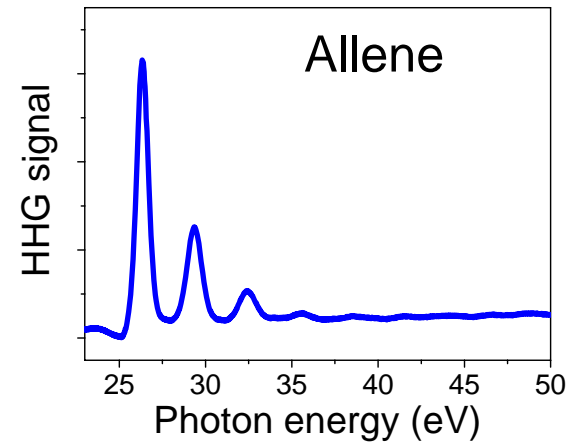
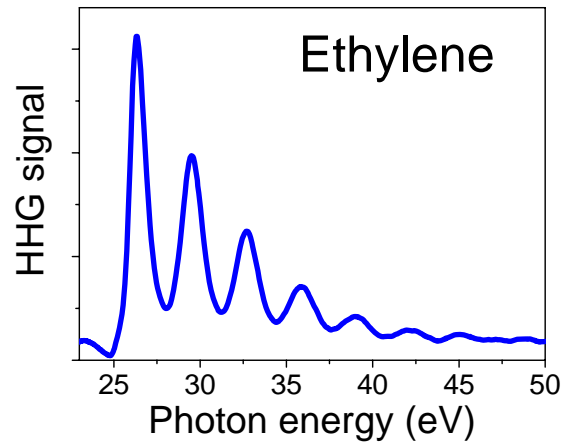
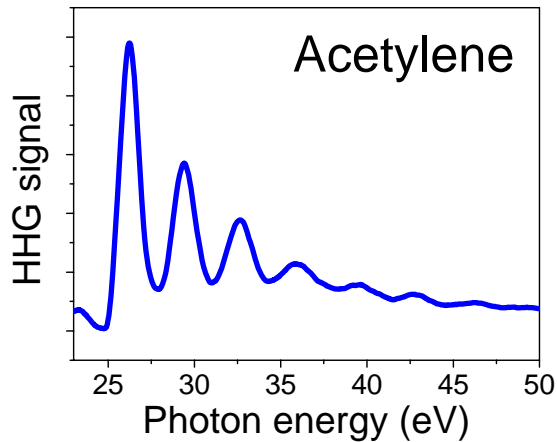

Limited harmonic range due to the low I_p (~ 10 eV) of the molecules.

$$\text{Cutoff: } E_{\text{fotón}} = I_p + 3.17 U_p$$

Ionization saturates at relatively low intensities, but...

$$U_p \sim I \lambda^2$$

We can extend the range of harmonics increasing the laser wavelength while keeping the intensity below the saturation threshold.

Drawback: HHG efficiency drops as λ^{-5} due to wavepacket dispersion in the continuum

Mid-IR HHG in aligned molecules (I)

Experimental setup

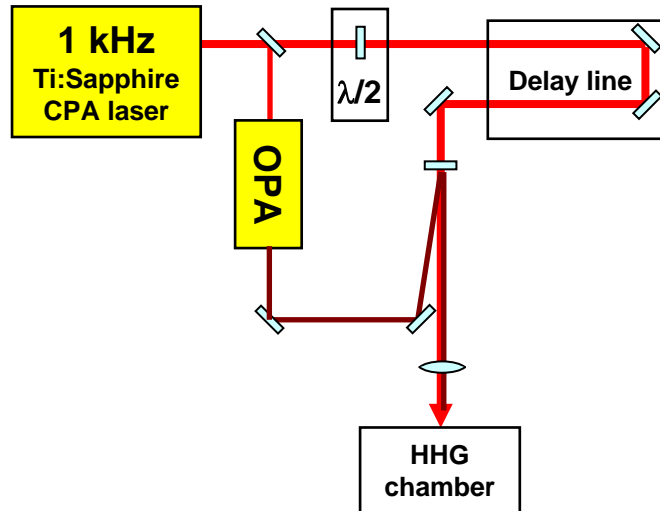

$$\lambda_{\text{align}} = 800 \text{ nm} \quad \left\{ \begin{array}{l} I_{\text{align}} \sim 5 \times 10^{13} \text{ W/cm}^2 \\ \tau_{\text{align}} \sim 80 \text{ fs} \end{array} \right.$$

$$\lambda_{\text{HHG}} = 1300 \text{ nm} \quad \left\{ \begin{array}{l} I_{\text{HHG}} \sim 2 \times 10^{14} \text{ W/cm}^2 \\ \tau_{\text{HHG}} \sim 50 \text{ fs} \end{array} \right.$$

N_2

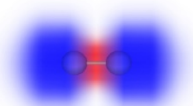

CO_2

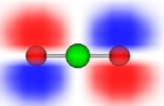

N_2O

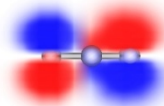

C_2H_2

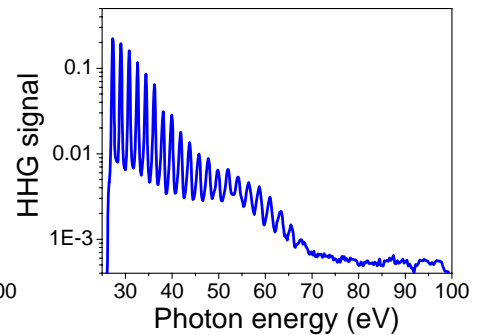
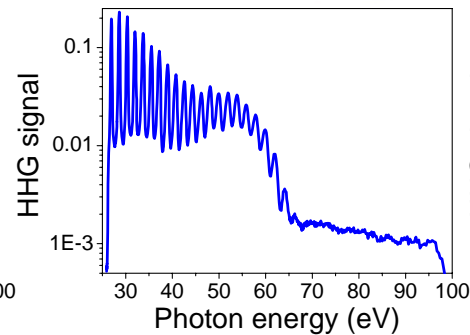
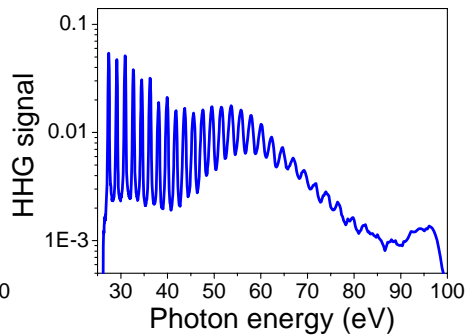
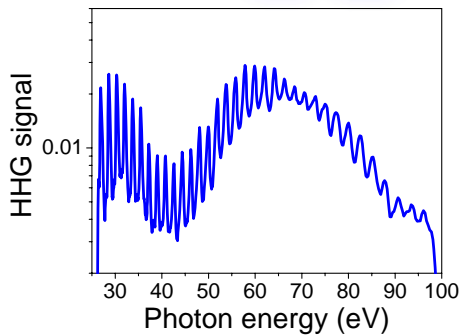
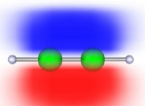

1 kHz mid-IR laser source provides high energy harmonics with a good signal/noise ratio

Mid-IR HHG in aligned molecules (II)

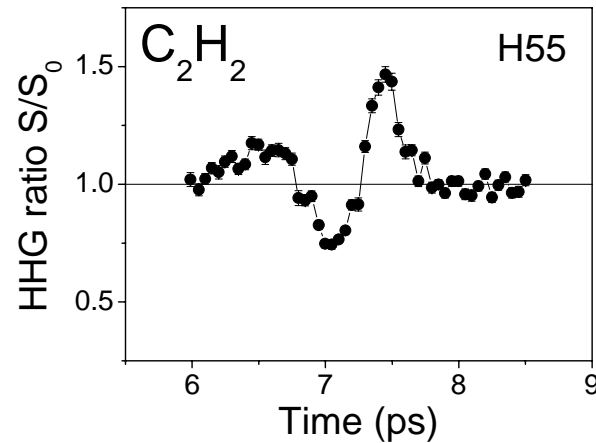
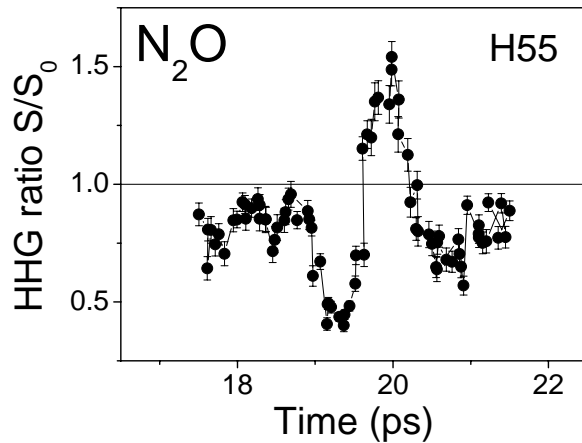
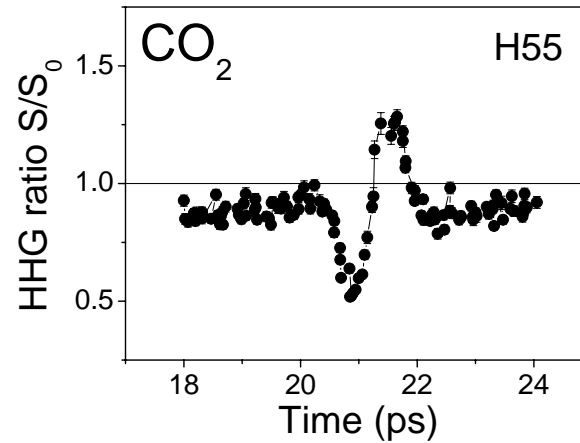
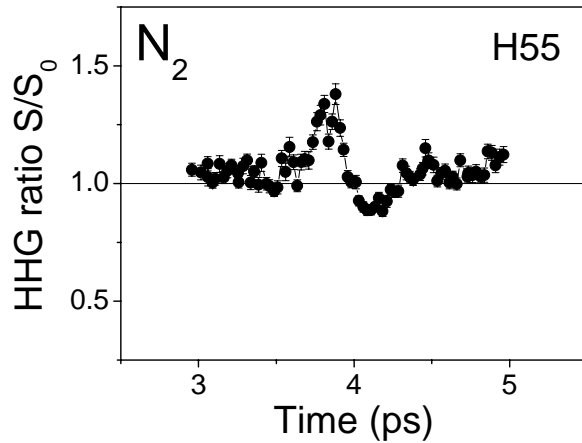

Large modulation in HHG signal at the half revival observed in high energy harmonics



Mid-IR HHG in aligned molecules (III)

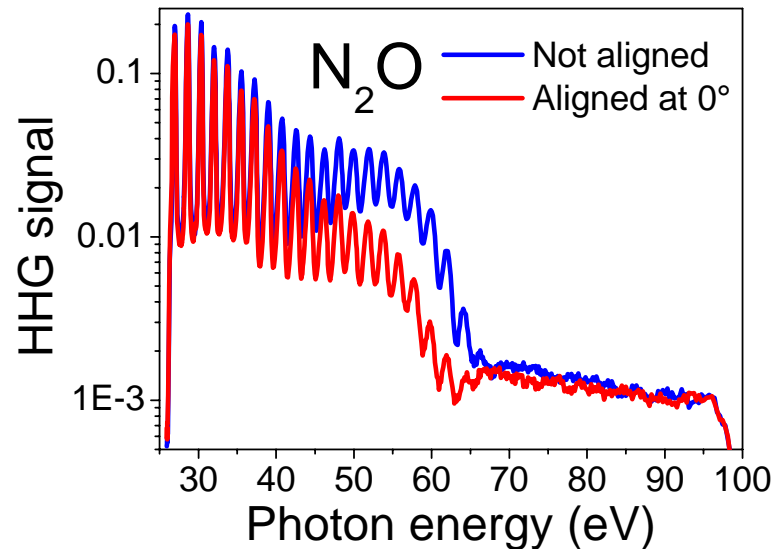
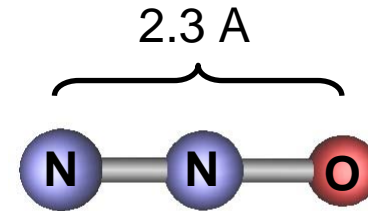
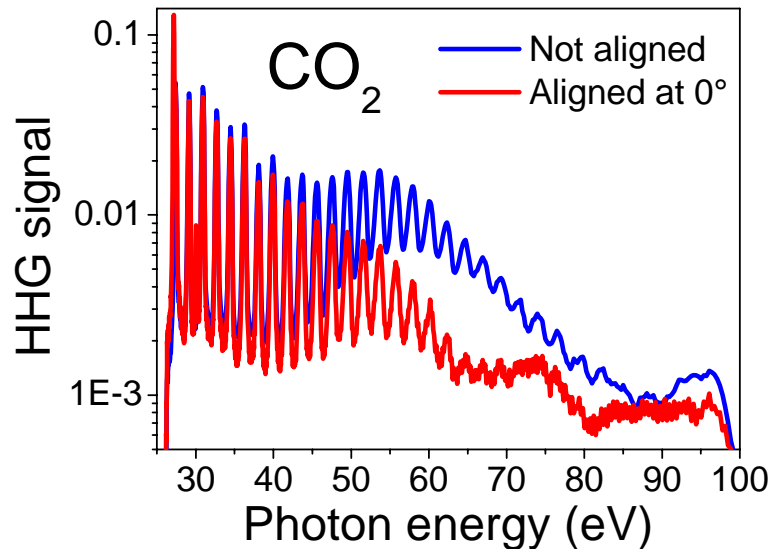
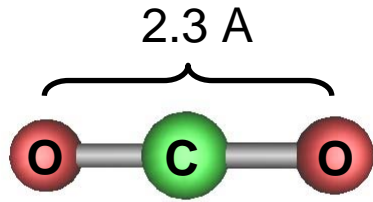

New evidence of harmonic suppression in aligned CO₂.

Evidence of harmonic suppression in aligned N₂O, not observed before, compatible with two-center interference.



The perfect wave

Is it possible to increase the electron recollision energy while keeping a high recollision probability?

What is the optimum electric field waveform that achieves this for a given total energy and periodicity?

A ramp with a DC offset maximises recollision energy: **The perfect wave.**

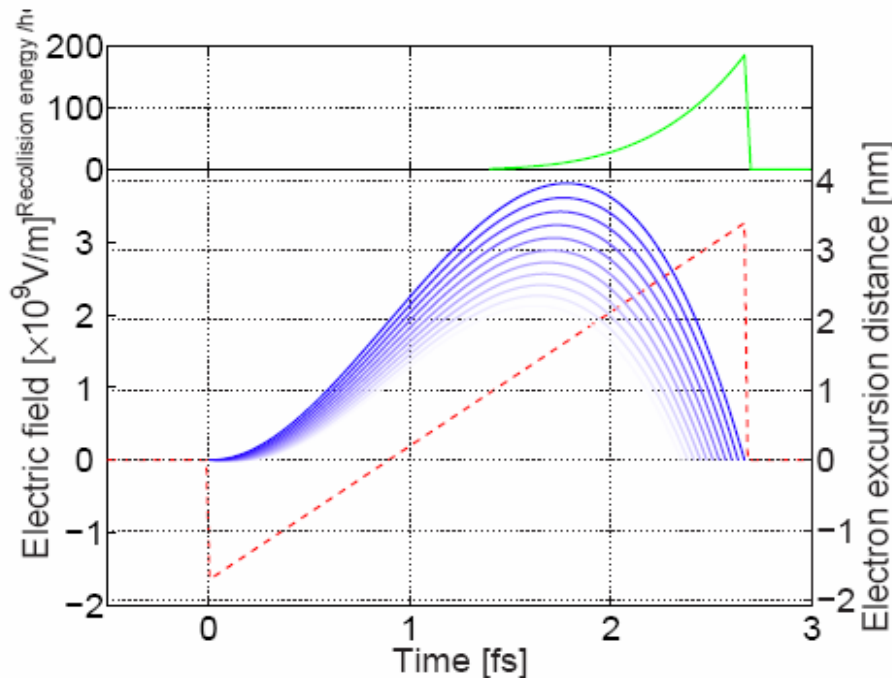

$$E(t) = \pm \sqrt{\frac{F}{T} \frac{2}{\pi \epsilon_0 c}} \left(\frac{3t}{T} - 1 \right)$$

Proven analytically

L. Chipperfield *et al.*,
Phys. Rev. Lett. 102, 063003 (2009)

**This is clearly an impractical waveform (!)
How might we approximate this in the lab?**

The perfect wave

An approximation to the sawtooth can be synthesised using a finite number of fields.

Waveform synthesized from **800nm** + **400nm** + **267nm** + **200nm** + **1600nm**
 ω + 2ω + 3ω + 4ω + 0.5ω

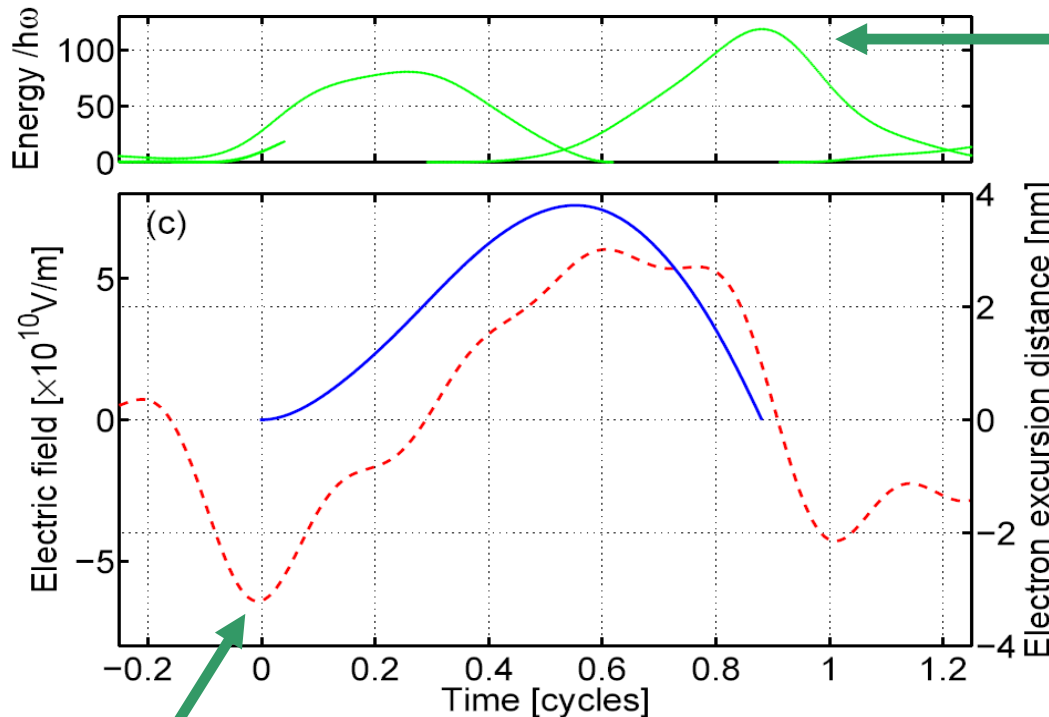

Peak recollision $\sim 7U_p$

Genetic algorithm used to find optimum amplitudes and phases of fields

| λ (nm) | Rel. Energy |
|----------------|-------------|
| 1600 | 0.5 |
| 800 | 1 |
| 400 | 0.08 |
| 267 | 0.05 |
| 200 | 0.03 |

High field here increases ionisation probability

The perfect wave

This waveform overcomes the efficiency reduction of using a long wavelength field

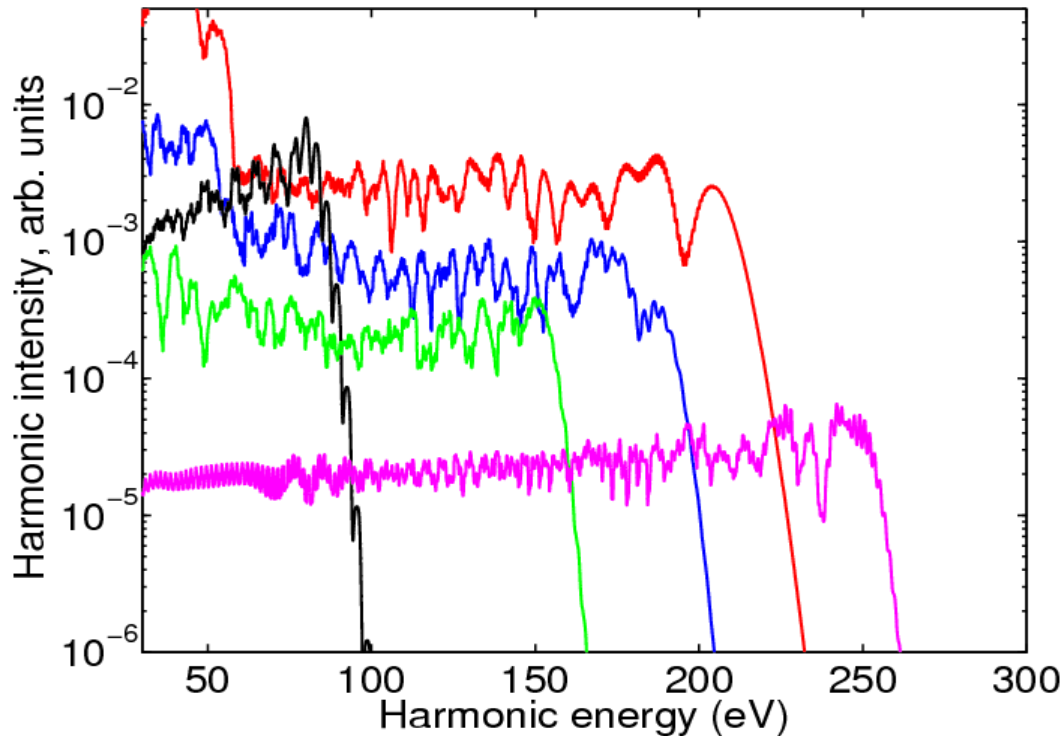

800nm

1200nm

1600nm

800 nm+1600 nm

Optimised:

800nm + 1600nm

+400nm + 267nm

+200nm

It works because the electron returns sooner, but still gains the high acceleration, compared to a longer wavelength.

The results of this waveform are robust to propagation in a realistic experimental conditions.

Two-colour HHG

HHG in Argon with **1300 nm** + **800 nm** ($\omega, 1.6 \omega$)

$$I_{1300\text{nm}} = I_{800\text{nm}} = 5 \times 10^{13} \text{ W/cm}^2$$

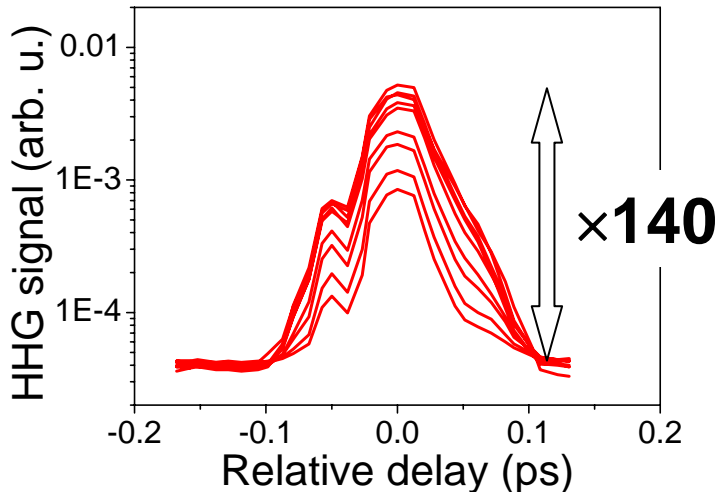
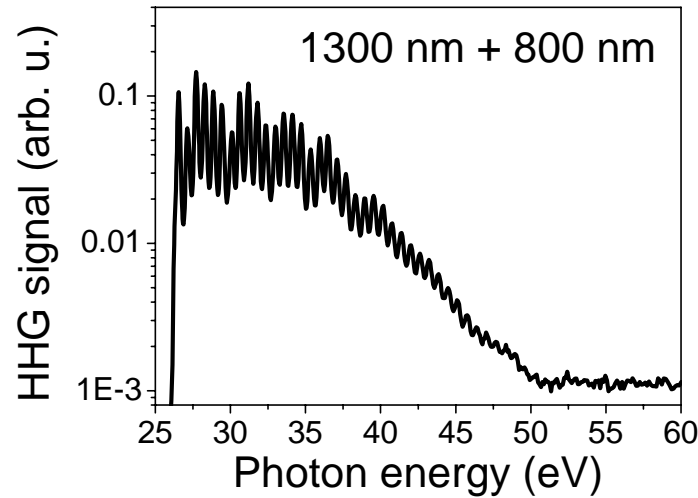
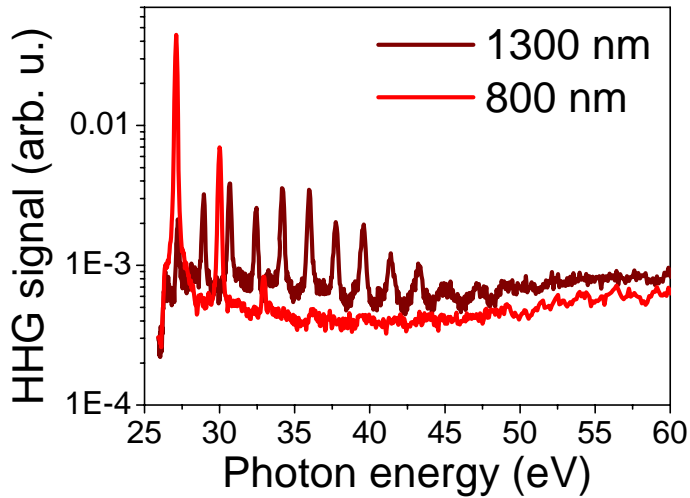

Together with the appearance of intermediate harmonics we observe an enhancement of more than **two orders of magnitude** in harmonic intensity when the two pulses ω and 1.6ω are overlapped.

Conclusions

- High harmonic generation has an enormous potential as an **ultrafast** probe of molecular systems.
- Part of the potential is due to our capability to **control** de measurements by controlling the target (**molecular alignment**) and the probe (**electron trajectories**).
- The use of high repetition rate (1 kHz) **mid-IR** laser sources is ideal to extend the number of harmonics available for imaging.
- A combination of pulses of **different wavelengths** can compensate the drop in efficiency of HHG in the mid-IR.
- The control of electron trajectories is essential to address some of the issues raised by the new ultrafast molecular imaging techniques.

Credits

**Ricardo Torres, Thomas Siegel, Leonardo Brugnera, Sarah Baker,
Luke Chipperfield, John Tisch, Jon Marangos**
Blackett Laboratory, Imperial College London, UK

Immacolata Procino, Jonathan G. Underwood
Department of Physics and Astronomy, University College London, UK

Nathaniel Kajumba
NRC, Ottawa, Canada

Carlo Altucci, Raffaele Velotta
Università di Napoli, Naples, Italy

Rebeca de Nalda
Instituto de Química Física, CSIC, Madrid, Spain

**Caterina Vozzi, Francesca Calegari, Salvatore Stagira, Giuseppe Sansone,
Mauro Nisoli**
Politécnico di Milano, Milan, Italy

Emma Springate, Chris Froud, Edmond Turcu
STFC, Rutherford Appleton Laboratory, Didcot, UK