

# Synthetic Quantum Matter: Quantum Simulation of ...

## Lattice Gauge Theories with Cold Atoms & Ions

Peter Zoller

overview / tutorial & recent work

HEP & cond mat



UNIVERSITY OF INNSBRUCK



OAW

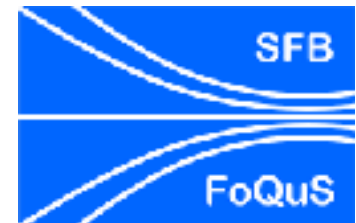

RYQS

# Synthetic Quantum Matter

## Controlled / engineered quantum many-body systems

- quantum computing
- quantum simulation
  - digital vs. analog

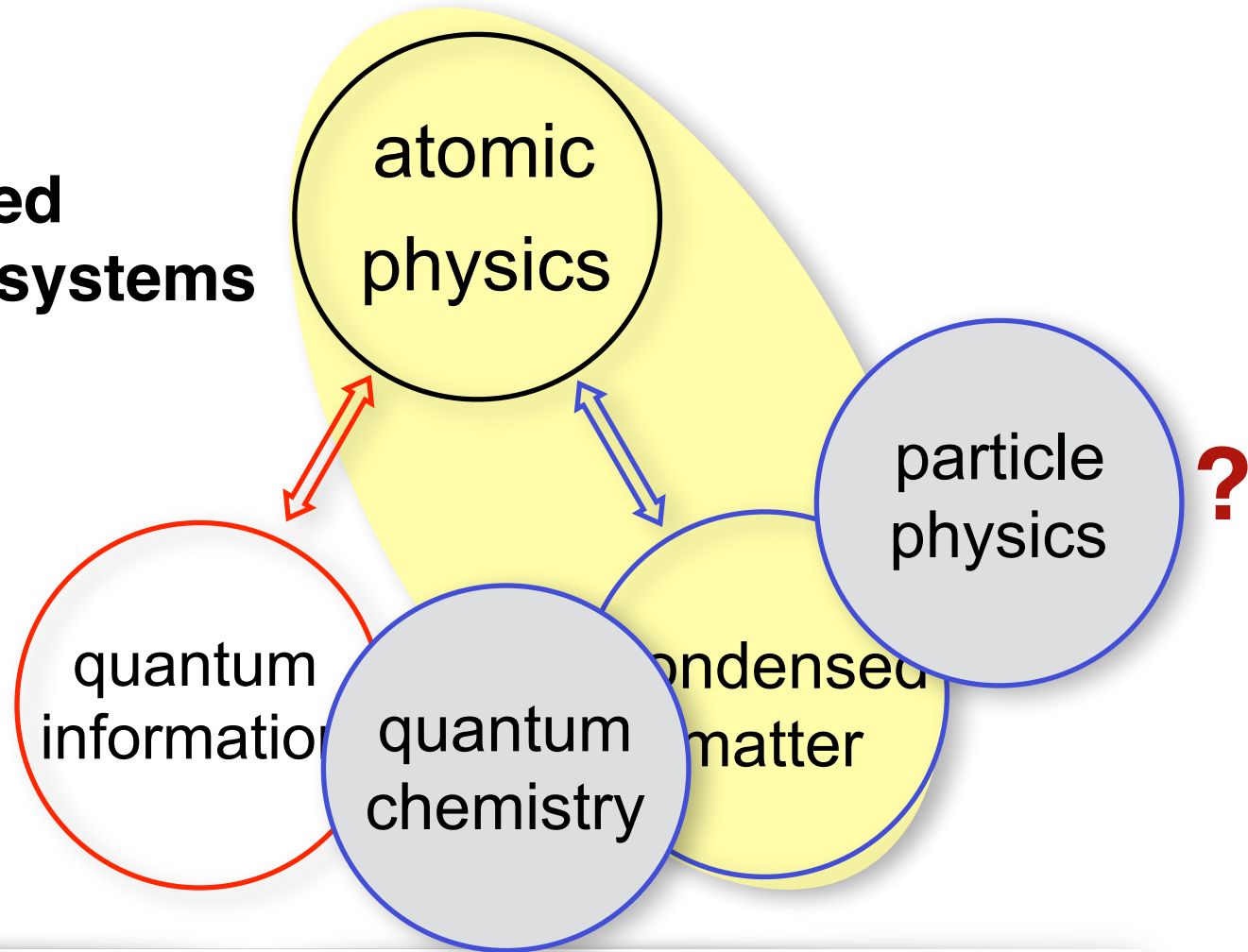

Trapped ions

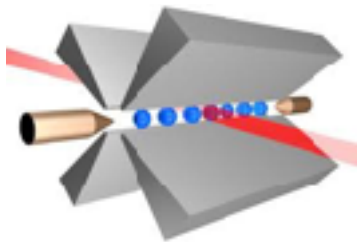

Optical Lattices

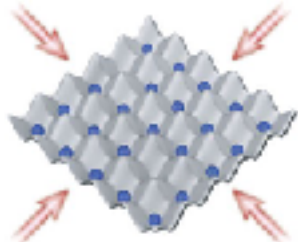

Rydberg

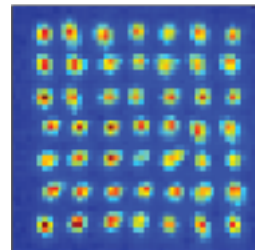

Polar Molecules

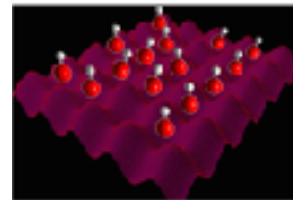

CQED & Photonic

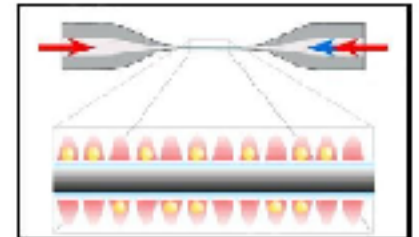

# ... lattice gauge theories [in particle physics]



K. Wilson 1974

- Gauge theories on a discrete lattice structure
- **Fundamental gauge symmetries:** standard model (every force has a gauge boson)



non-perturbative approach to fundamental theories of matter (e.g. QCD)

→ **classical statistical mechanics**

## Classical Monte Carlo simulations:

### achievements

- first evidence of quark-gluon plasma
- ab initio estimate of proton mass
- entire hadronic spectrum

### issues

- Sign problem in its various flavors:
- finite density QCD (=fermions)
  - real time evolution

Quantum simulation (with atoms)? ... toy models & simple phenomena

# Lattice Gauge Collaborations

## Innsbruck - Theory



C. Muschik

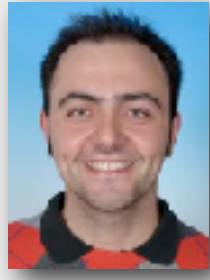

M. Dalmonte



P. Hauke

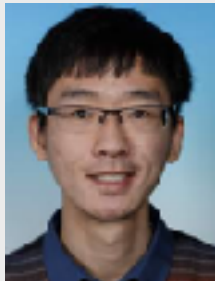

D. Yang



A. Glätzle



E. Rico

## Innsbruck - Ion Experiment

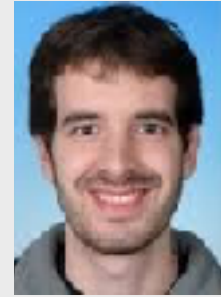

E. Martinez



R. Blatt

## Ulm, Dresden, Mainz...

S. Montangero, M. Heyl, R. Mössner,  
F. Schmidt-Kaler, ...

## High Energy Theory @ Bern

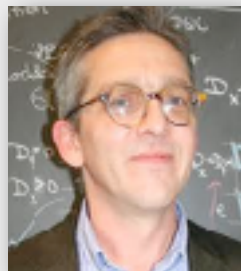

U.-J. Wiese



D. Banerjee

related work: Cirac-Reznik,  
Lewenstein, Berges-Oberthaler,  
Mueller ...

## Representative papers and reviews

Zohar, E., Cirac, J. I., & Reznik, B. (Rep. Prog. Phys. 2015).

Quantum simulations of lattice gauge theories using ultracold atoms in optical lattices.

Wiese, U. J. (*Annalen der Physik* 2013). Ultracold quantum gases and lattice systems: quantum simulation of lattice gauge theories.

Dutta, O., Tagliacozzo, L., Lewenstein, M., & Zakrzewski, J. (*arXiv:1601.03303*).

Toolbox for Abelian lattice gauge theories with synthetic matter.

## Innsbruck papers

Büchler, H. P., Hermele, M., Huber, S. D., Fisher, M. P., & PZ. (PRL 2005).

Atomic quantum simulator for lattice gauge theories and ring exchange models..

Banerjee, D., Dalmonte, M., Müller, M., Rico, E., Stebler, P., Wiese, U. J., & PZ. (PRL 2012).

Atomic quantum simulation of dynamical gauge fields coupled to fermionic matter:

Banerjee, D., Bögli, M., Dalmonte, M., Rico, E., Stebler, P., Wiese, U. J., & PZ (PRL 2013).

Atomic quantum simulation of  $U(N)$  and  $SU(N)$  non-Abelian lattice gauge theories.

Hauke, P., Marcos, D., Dalmonte, M., & PZ. (PRX 2013).

Quantum simulation of a lattice Schwinger model in a chain of trapped ions.

Glaetzle, A. W., Dalmonte, M., Nath, R., Roussochatzakis, I., Moessner, R., & PZ (PRX 2014).

Quantum spin-ice and dimer models with Rydberg atoms.

Glaetzle, A. W., Dalmonte, M., Nath, R., Gross, C., Bloch, I., & PZ (PRL 2015).

Designing frustrated quantum magnets with laser-dressed Rydberg atoms.

Stannigel, K., Hauke, P., Marcos, D., Hafezi, M., Diehl, S., Dalmonte, M., & PZ (PRL 2014).

Constrained dynamics via the Zeno effect in quantum simulation: ... non-Abelian lattice gauge theories

Laflamme, C., et al., H., Bietenholz, W.iese UJ & PZ. (*Annals of Physics*, 2016).

CP quantum field theories with alkaline-earth atoms in optical lattices

# Real-time dynamics of lattice gauge theories with a few-qubit quantum computer

doi:10.1038/nature18318

Esteban A. Martinez<sup>1\*</sup>, Christine A. Muschik<sup>2,3\*</sup>, Philipp Schindler<sup>1</sup>, Daniel Nigg<sup>1</sup>, Alexander Erhard<sup>1</sup>, Markus Heyl<sup>2,4</sup>, Philipp Hauke<sup>2,3</sup>, Marcello Dalmonte<sup>2,3</sup>, Thomas Monz<sup>1</sup>, Peter Zoller<sup>2,3</sup> & Rainer Blatt<sup>1,2</sup>

## Schwinger pair production

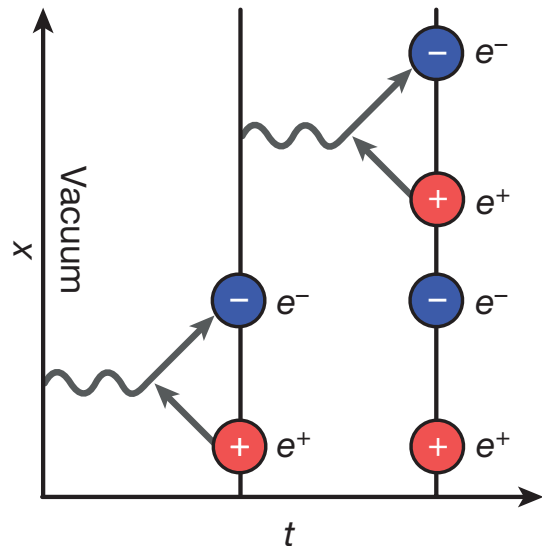

## ion trap quantum computer

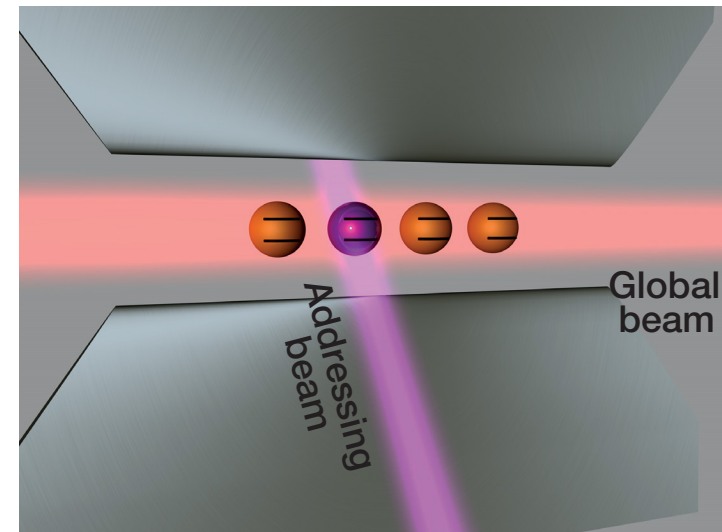

## Schwinger Model: 1+1D QED

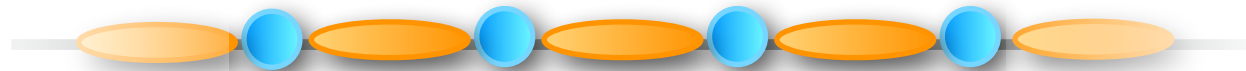

$$\hat{H}_{\text{lat}} = -i w \sum_{n=1}^{N-1} \left[ \hat{\Phi}_n^\dagger e^{i\hat{\theta}_n} \hat{\Phi}_{n+1} - \text{h.c.} \right] + J \sum_{n=1}^{N-1} \hat{L}_n^2 + m \sum_{n=1}^N (-1)^n \hat{\Phi}_n^\dagger \hat{\Phi}_n$$

Kogut-Susskind Hamiltonian (Wilson LGT)

# Real-time dynamics of lattice gauge theories with a few-qubit quantum computer

## Schwinger pair production

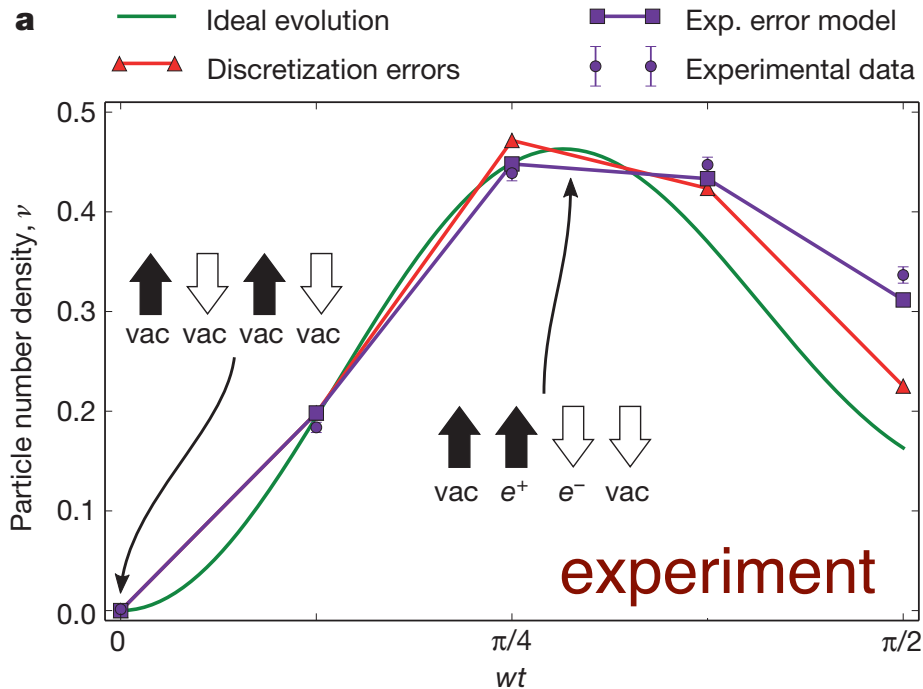

## ion trap quantum computer

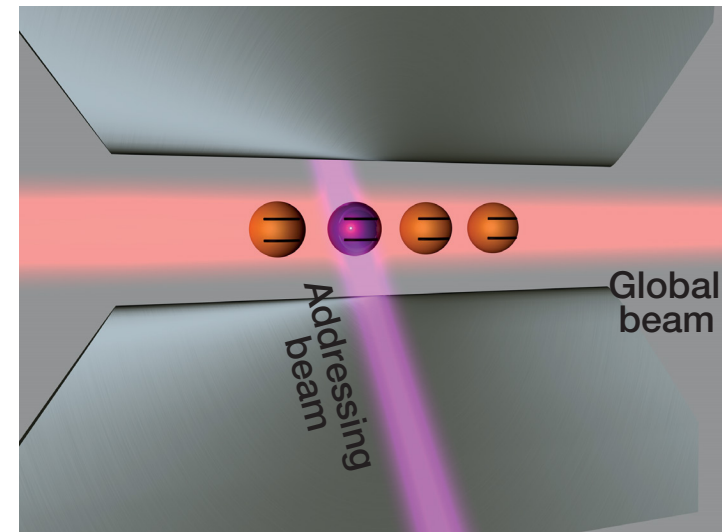

## Digital Quantum Simulation of an Exotic Spin Model

- obtained after integrating out gauge field

# Atomic Simulation of LGTs

## Lattice gauge theory

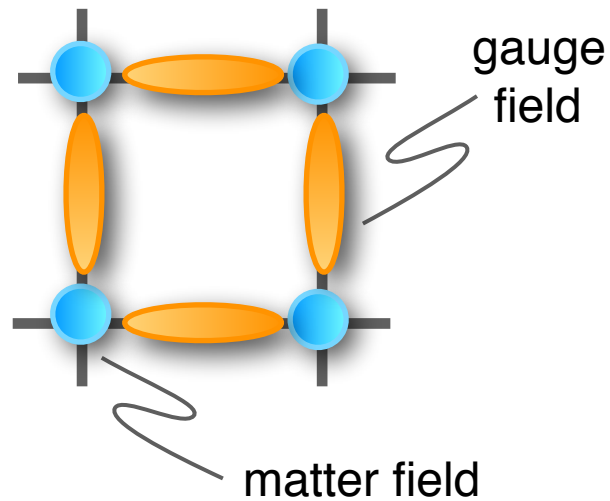

(Non-)Abelian LGT:

✓ QED  $U(1)$

✓ QCD  $SU(N)$ ,  $U(N)$

## Analog Quantum Simulation

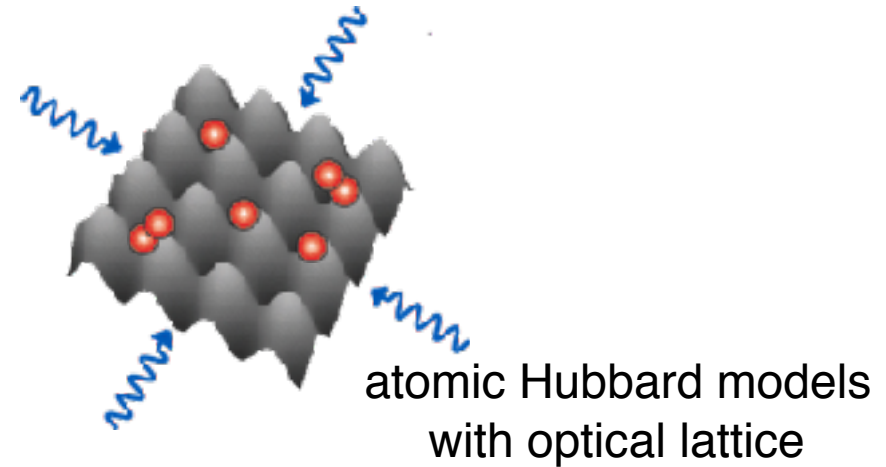

## Digital Quantum Simulation

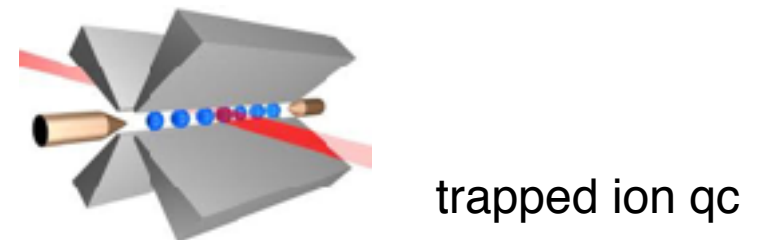

... 'build' / emulate with atomic models

- Kogut-Susskind Hamiltonians [Wilson]
- Quantum Link Models [Wiese]



## From STATIC to DYNAMICAL gauge fields

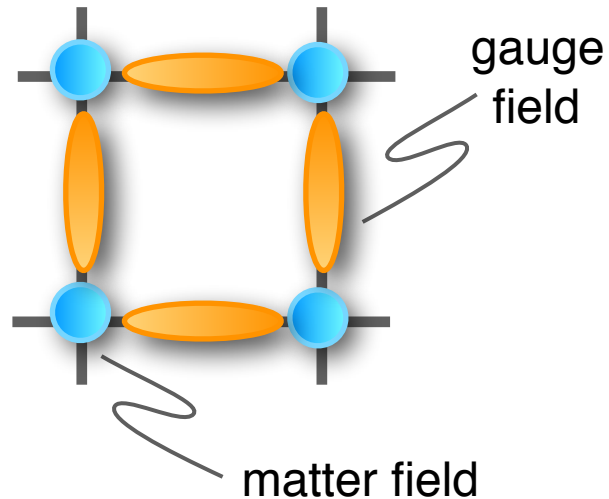

... an AMO perspective

## ... and the Schwinger Lattice Model

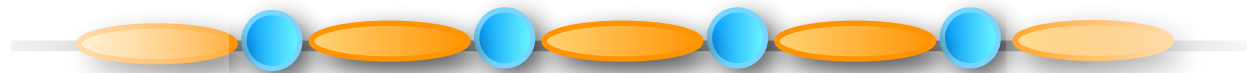

✓ Wilson vs. Quantum Link

✓ ions / digital vs. atoms / analog

# Static vs. Dynamical Gauge Fields

- **c-number / static gauge field**

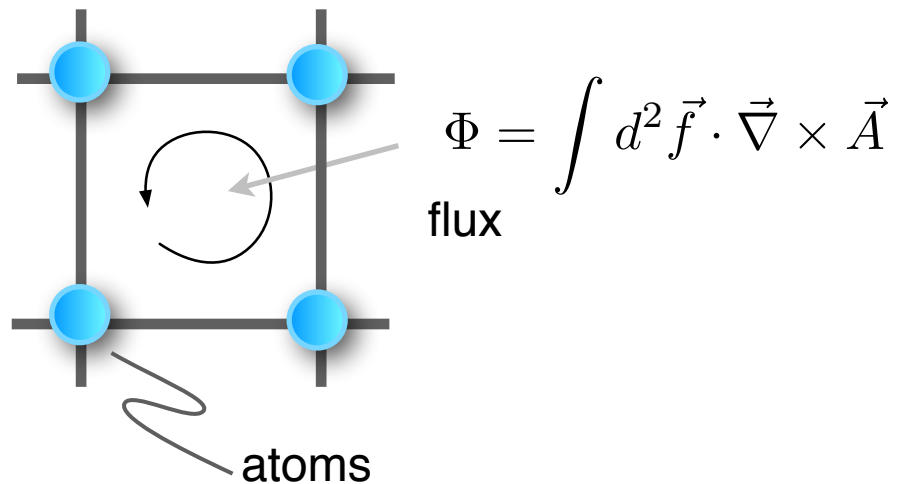

“synthetic gauge fields”

- Hofstadter butterfly
- Chern insulators
- Fractional Chern insulators

Two blue atoms labeled x and y are connected by a horizontal orange line. A curved arrow above the line points from y to x.

$$H = -t\psi_x^\dagger e^{i\varphi_{xy}} \psi_y + \text{h.c.}$$

phase  $\varphi_{xy} = \int_x^y d\vec{l} \cdot \vec{A}$

U(1) (abelian)

Peierls substitution

Review: N. Goldman, J. Budich & PZ, Nature Physics (2016)

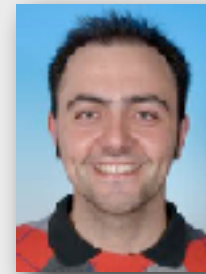

M. Dalmonte  
UIBK

L. Fallani  
LENS, Florence

M. Inguscio

QUANTUM SIMULATION

# Observation of chiral edge states with neutral fermions in synthetic Hall ribbons

M. Mancini,<sup>1</sup> G. Pagano,<sup>1</sup> G. Cappellini,<sup>2</sup> L. Livi,<sup>2</sup> M. Rider,<sup>3,4</sup> J. Catani,<sup>5,2</sup> C. Sias,<sup>6,2</sup> P. Zoller,<sup>3,4</sup> M. Inguscio,<sup>6,1,2</sup> M. Dalmonte,<sup>3,4</sup> L. Fallani<sup>1,2\*</sup>

<sup>173</sup>Yb fermions

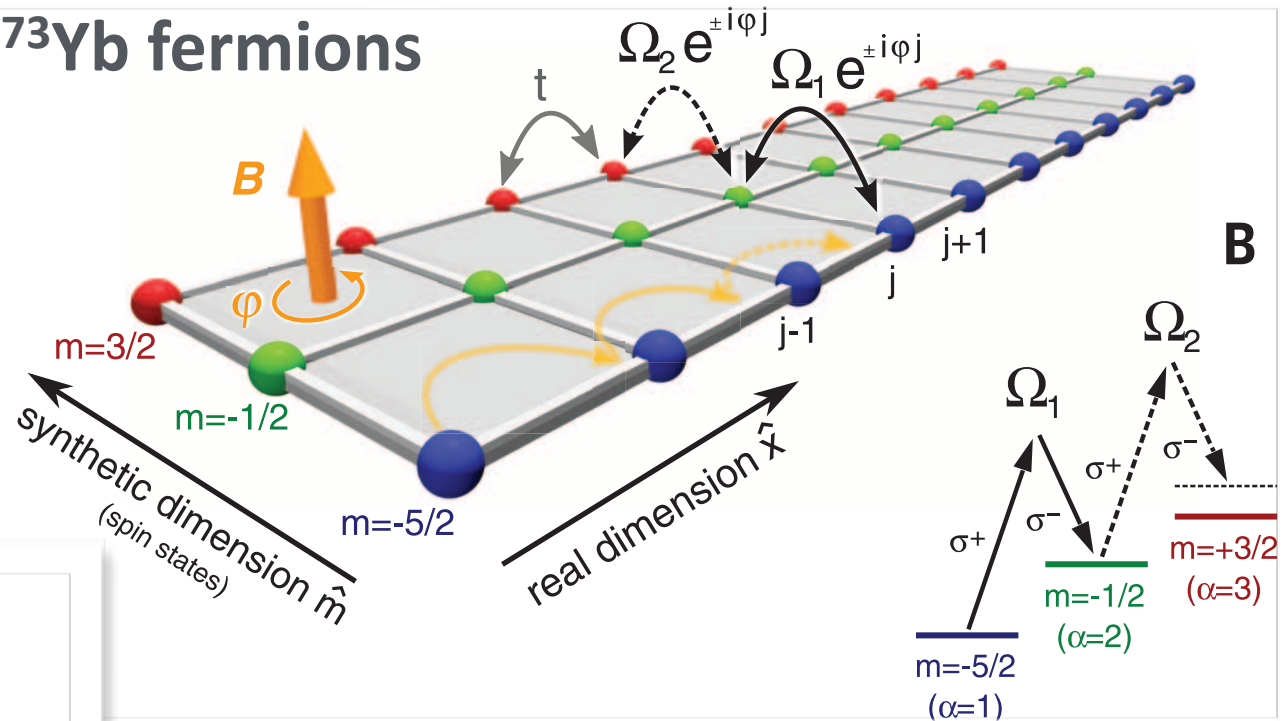

$$H = \sum_j \sum_m -t(c_{j,m}^\dagger c_{j+1,m} + \text{h.c.}) + \sum_j \sum_m \frac{\Omega}{2} (e^{i\phi j} c_{j,m}^\dagger c_{j,m+1} + \text{h.c.})$$

See also: I. Spielman et al., *ibid.* (bosons)

# Particle in a [synthetic] magnetic field

cyclotron orbit in B-field

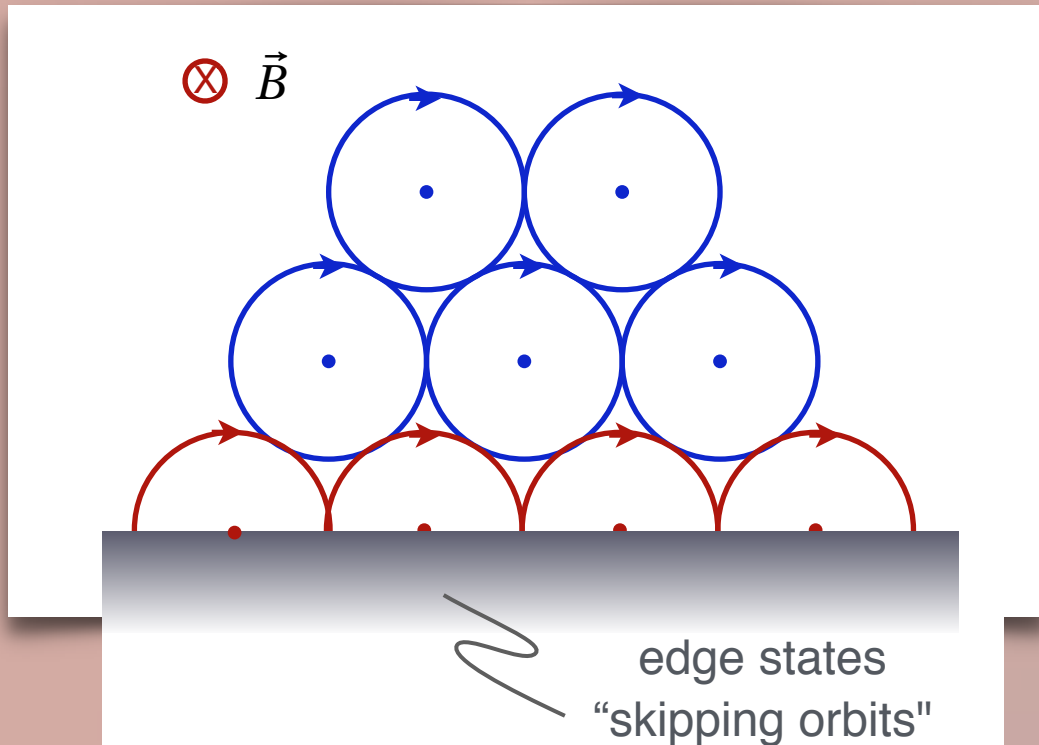

quantum wave packet



© L. Fallani

Initial state with  $\langle k \rangle = 0$  on the  $m = -5/2$  leg

Quenched dynamics after activation of synthetic tunneling

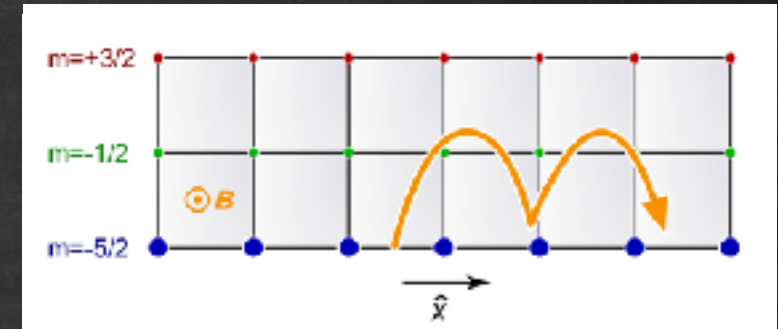

Magnetization:

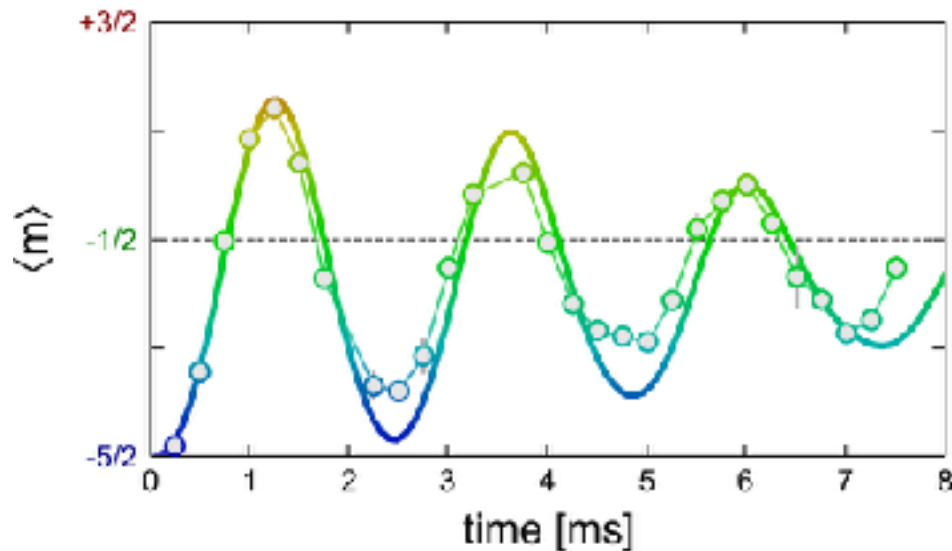
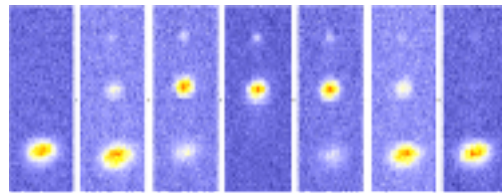

Momentum:

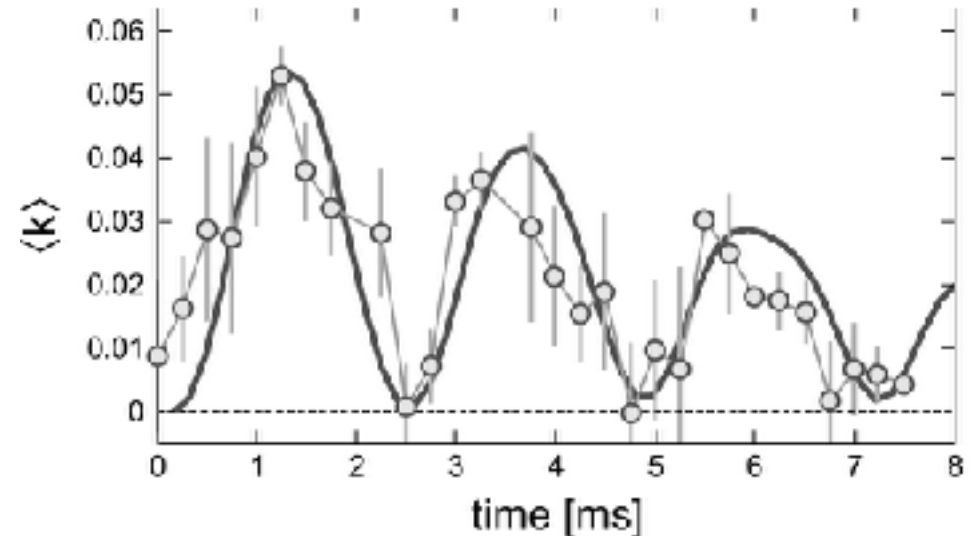
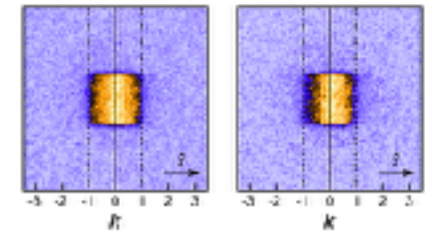

# Static vs. *Dynamical* Gauge Fields: U(1)

- **dynamical gauge fields**

particles hopping around a plaquette assisted by link degrees of freedom

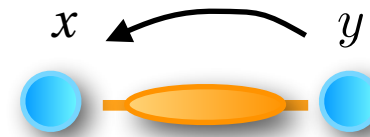
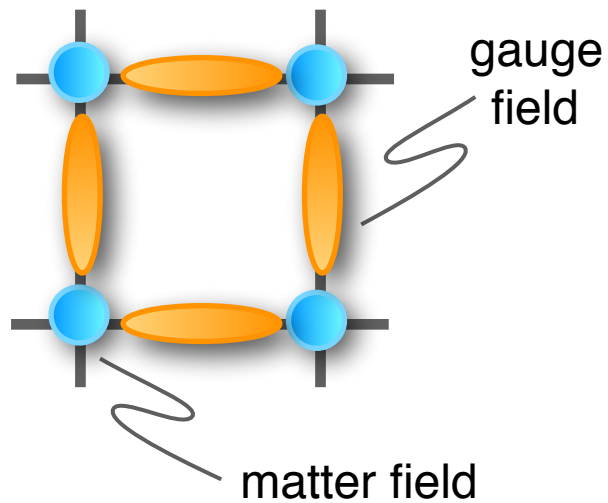

$$H = -t\psi_x^\dagger U_{xy}\psi_y + \text{h.c.} + \dots$$

link operator

# Static vs. *Dynamical* Gauge Fields: U(1)

- dynamical gauge fields**

particles hopping around a plaquette assisted by link degrees of freedom

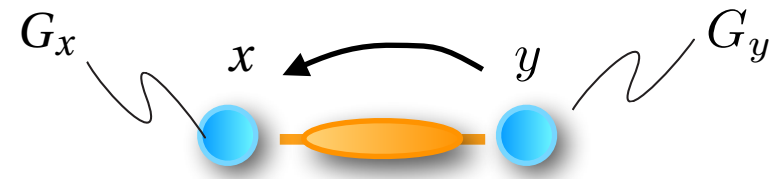
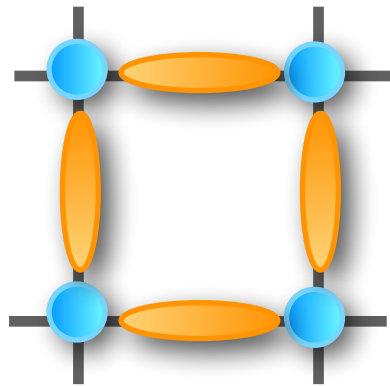

$$H = -t\psi_x^\dagger U_{xy}\psi_y + \text{h.c.} + \dots$$

## gauge (*local*) symmetry U(1)

gauge bosons	$U_{xy}$	$\xrightarrow{V}$	$e^{i\alpha_x} U_{xy} e^{-i\alpha_y},$
fermions	$\psi_x$	$\xrightarrow{V}$	$e^{i\alpha_x} \psi_x$

unitary trafo:

$$V = \prod_x e^{i\alpha_x G_x}$$

generator

## *local* conserved quantity

$$[H, G_x] = 0 \quad \forall x$$

↑  
generator of gauge transformation

# Static vs. *Dynamical* Gauge Fields: U(1)

- dynamical gauge fields**

particles hopping around a plaquette assisted by link degrees of freedom

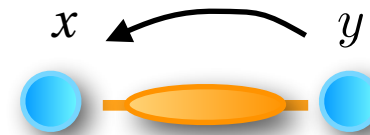
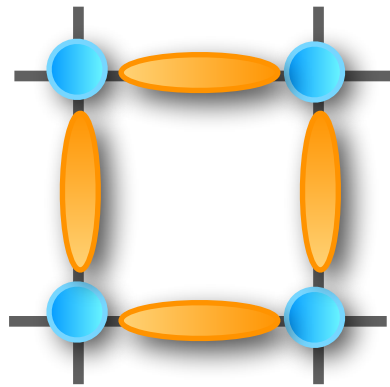

$$H = -t\psi_x^\dagger U_{xy}\psi_y + \text{h.c.} + \dots$$

## Gauss Law

$$G_x = \underbrace{\psi_x^\dagger \psi_x}_{\text{matter}} - \sum_i \underbrace{\left( E_{x, x+\hat{i}} - E_{x-\hat{i}, x} \right)}_{\text{electric field operator}}$$



$$\rho - \nabla \cdot E = 0$$

## local conserved quantity

$$[H, G_x] = 0 \quad \forall x$$

↑  
generator of gauge transformation



# QED with Spins [Quantum Link Model]



quantum spin ice

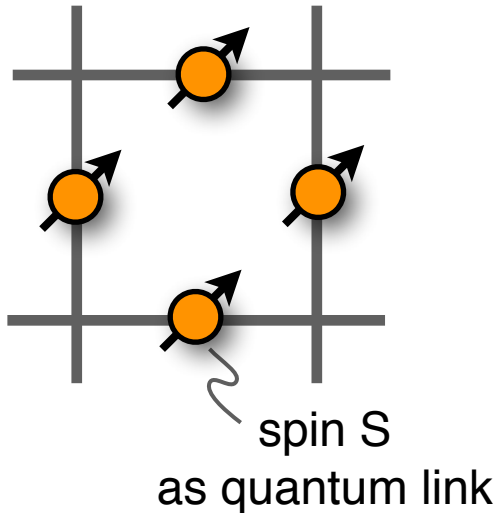

$$U_{x,x+1} \rightarrow S_{x,x+1}^+ \quad E_{x,x+1} \rightarrow S_{x,x+1}^z$$

electric flux

Spin  $S=1/2, 1, \dots$

quantum link carrying an electric flux

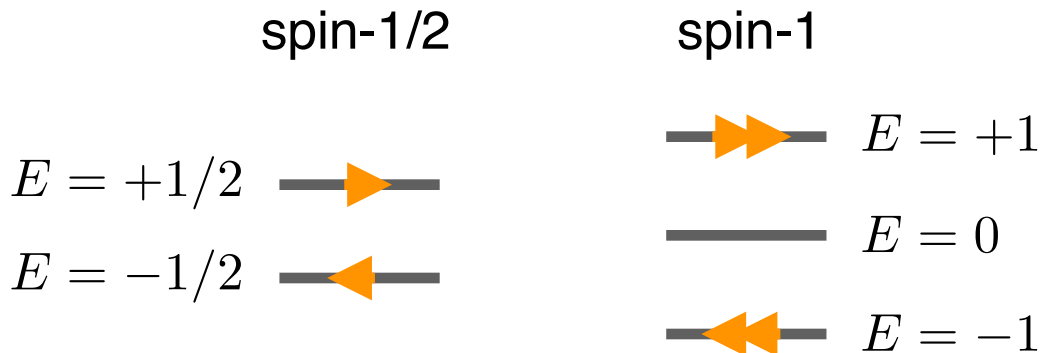

# QED with Spins [Quantum Link Model]

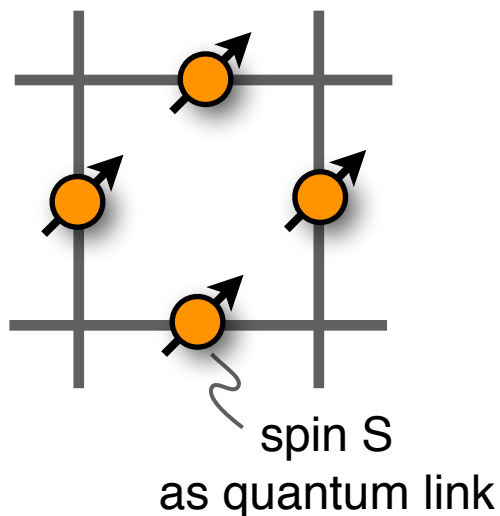

$$U_{x,x+1} \rightarrow S_{x,x+1}^+ \quad E_{x,x+1} \rightarrow S_{x,x+1}^z$$

electric flux

Spin  $S=1/2, 1, \dots$

configurations: spin-1/2

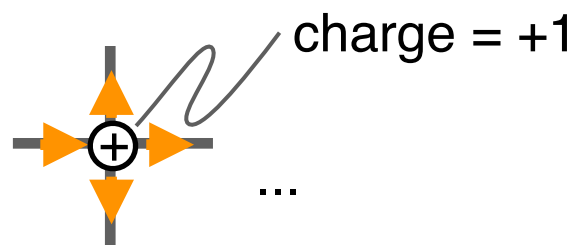

**Gauss Law**

$$\rho - \nabla \cdot E = 0$$

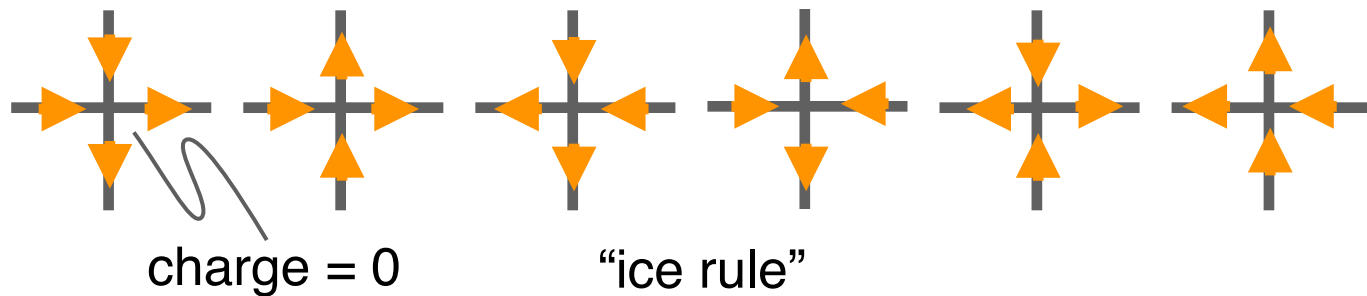

# QED with Spins [Quantum Link Model]

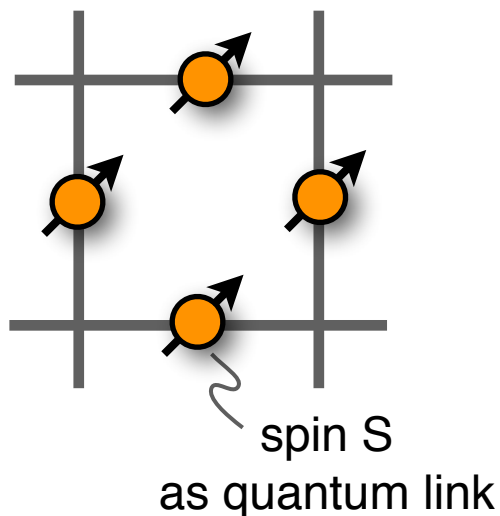

$$U_{x,x+1} \rightarrow S_{x,x+1}^+ \quad E_{x,x+1} \rightarrow S_{x,x+1}^z$$

electric flux

Spin  $S=1/2, 1, \dots$

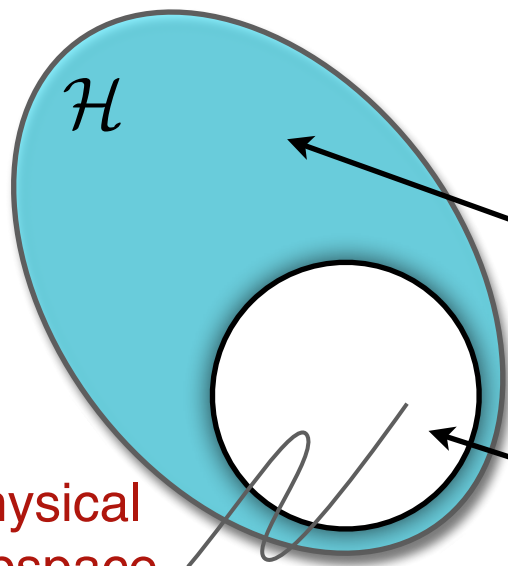

configurations: spin-1/2

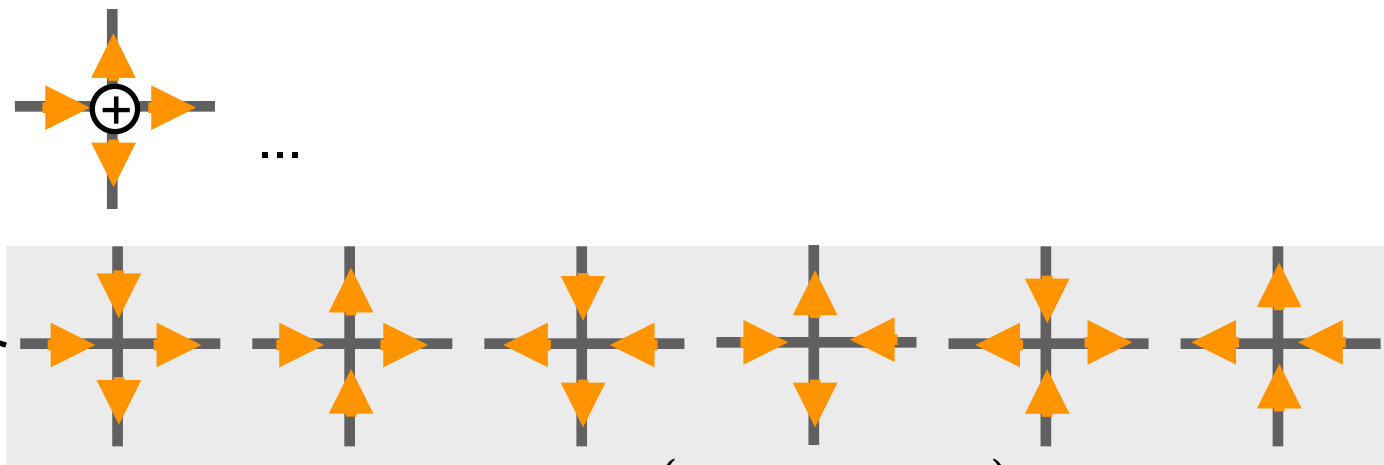

$$G_x |\psi\rangle = 0 \quad \forall x$$

“ice rule”  $G_x = \sum_{\mu} (S_{x-\hat{\mu},\mu}^3 - S_{x,\mu}^3) \leftrightarrow \nabla \cdot E = 0$

# QED with Spins [Quantum Link Model]

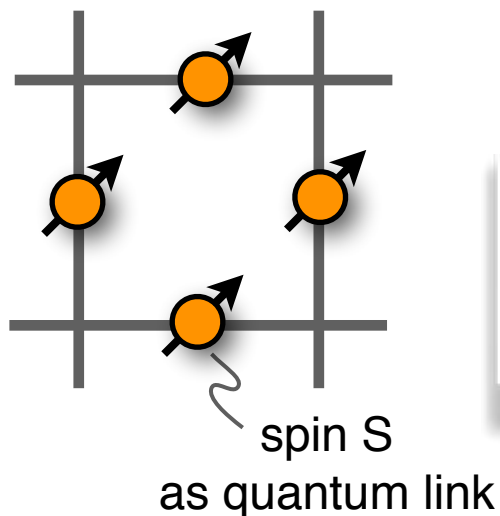

**Hamiltonian**

$$H = \frac{g^2}{2} \sum_{\langle xy \rangle} E_{xy}^2 - \frac{1}{4g^2} \sum_{\langle wxyz \rangle} (U_{wx} U_{xy} U_{yz} U_{zw} + \text{h.c.}),$$

$S_{xy}^3$                        $S_{wx}^+$   
 $\downarrow$                                        $\downarrow$   
 electric energy                      magnetic energy

configurations: spin-1/2

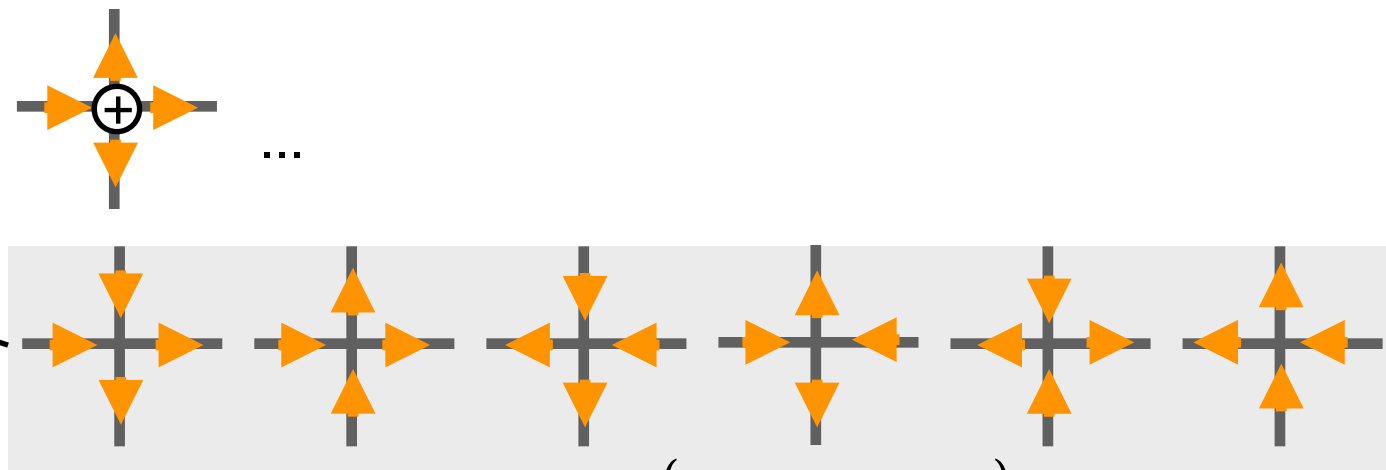
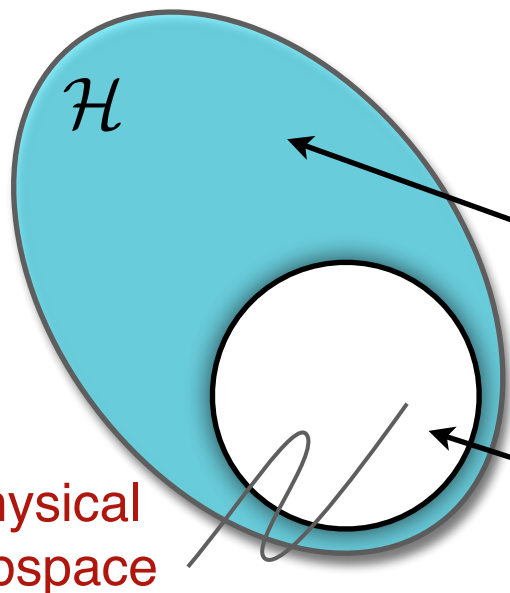

$$G_x |\psi\rangle = 0 \quad \forall x$$

“ice rule”  $G_x = \sum_{\mu} (S_{x-\hat{\mu},\mu}^3 - S_{x,\mu}^3) \leftrightarrow \nabla \cdot E = 0$

# Hamiltonian: Ring Exchange

tunneling between Ice-rule configurations

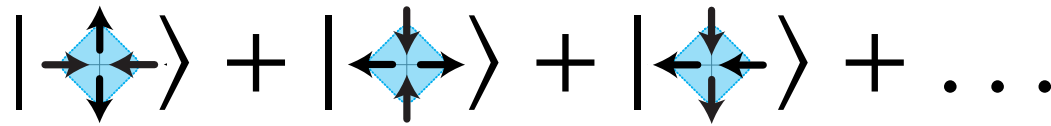

Quantum Spin Liquids (3D)  
Resonating Valence bonds solid (2D)

Non-trivial dynamics of Quantum Spin Ice models

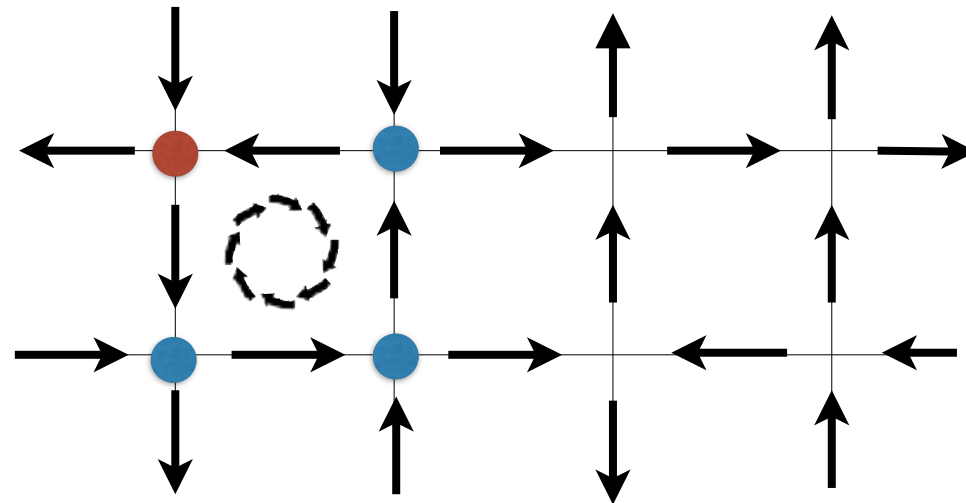

**Minimal  
Hamiltonian for  
quantum ice**

$$H = J \sum_{j,i,k,\ell \in \square} S_j^+ S_i^- S_k^+ S_\ell^-$$

# Cond Mat: From *Classical* to *Quantum* Spin Ice

- **classical spin ice**

- magnetic rare earth atoms with large electron spins  
 $\text{Dy}_2\text{Ti}_2\text{O}_7$ ,  $\text{Ho}_2\text{Ti}_2\text{O}_7$ ,  $\text{Ho}_2\text{Sn}_2\text{O}_7$
- pyrochlore lattice

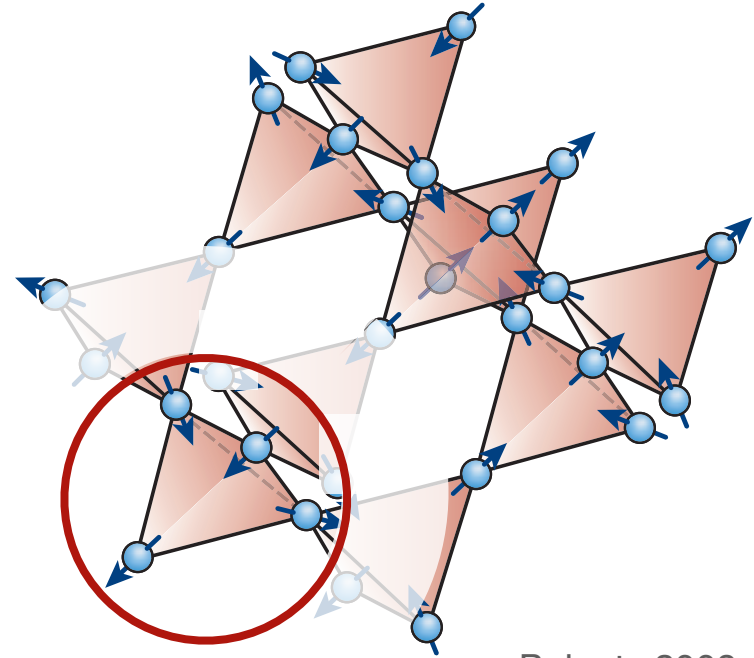

Balents 2008

- **quantum spin ice**

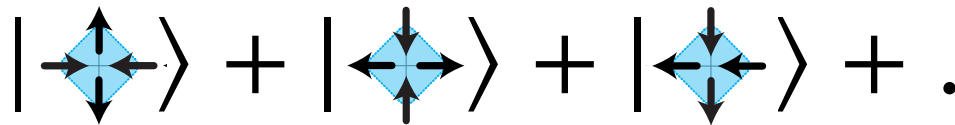

quantum superpositions

“ice rule” = strong correlations  
analogy to electromagnetism

**Quantum Spin Liquids (3D)**  
**Resonating Valence bonds solid (2D)**

---

L. Balents, Insight Article in Nature 464, 199 (2010)

C. L. Henley, Annual Review of Condensed Matter Physics 1, 179 (2010)

C. Castelnovo, R. Moessner, and S.L. Sondhi, Annual Review of Condensed Matter Physics (2011)

# QED with Spins [Quantum Link Model]

- ... putting matter back

superpositions of configurations  
satisfying ice rule

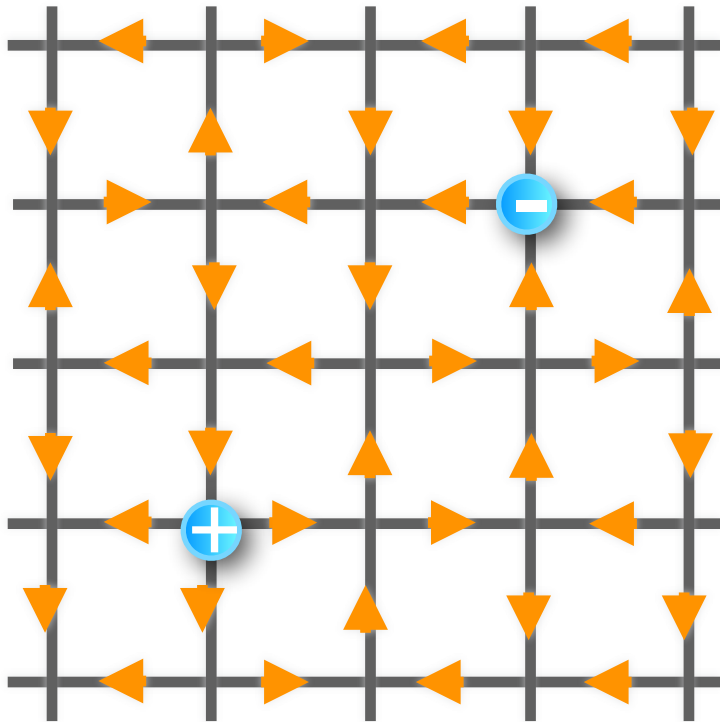

“two in & two out”



# Schwinger Lattice Model: (1+1)D QED

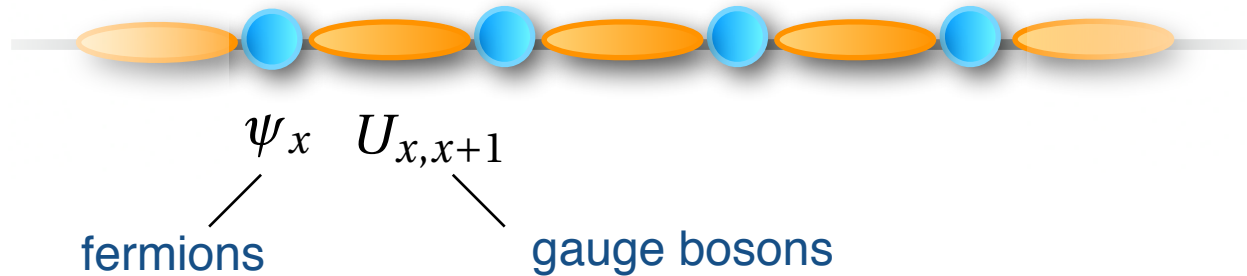

Wilson & Quantum Link



# Schwinger Model

- QED in 1+1D: U(1) gauge theory

$$S^M = \int d^2 x \mathcal{L}^M \quad \text{Minkowski action (real time)}$$

$$\mathcal{L}^M = -\frac{1}{4} F_{\mu\nu} F^{\mu\nu} + \bar{\psi} \{ i \sigma^{\mu M} (\partial_\mu + i g A_\mu) - m_0 \} \psi \quad (\mu = 0, 1)$$

$$\text{Dirac spinor} \quad \psi = \begin{pmatrix} u \\ d \end{pmatrix}$$

$$\text{EM field strength} \quad F_{\mu\nu} = \partial_\mu A_\nu - \partial_\nu A_\mu$$

$$\gamma^0 \equiv \sigma^{0M} = \begin{pmatrix} 0 & 1 \\ 1 & 0 \end{pmatrix} \quad \gamma^1 \equiv \sigma^{1M} = \begin{pmatrix} 0 & 1 \\ -1 & 0 \end{pmatrix} \quad \gamma^5 \equiv \sigma^{3M} = -\sigma^{0M} \sigma^{1M} = \begin{pmatrix} 1 & 0 \\ 0 & -1 \end{pmatrix}$$

---

Euclidean ...

# 1. Schwinger: Quantum Link Model

- Hamiltonian

$$H = -t \sum_x \left[ \psi_{x+1}^\dagger S_{x,x+1}^+ \psi_x + \text{h.c.} \right] + m \sum_x (-1)^x \psi_x^\dagger \psi_x + \frac{g^2}{2} \sum_x (S_{x,x+1}^z)^2$$

hopping

staggered fermions

electric field energy



$\psi_x$   
fermions

$U_{x,x+1}$

gauge bosons

$$U_{x,x+1} = S_{x,x+1}^+$$

$$E_{x,x+1} = S_{x,x+1}^z$$

# Schwinger: Quantum Link Model

- **Hamiltonian**

$$H = -t \sum_x \left[ \psi_{x+1}^\dagger S_{x,x+1}^+ \psi_x + \text{h.c.} \right] + m \sum_x (-1)^x \psi_x^\dagger \psi_x + \frac{g^2}{2} \sum_x (S_{x,x+1}^z)^2$$

hopping

staggered fermions

electric field energy



## Staggered fermions:

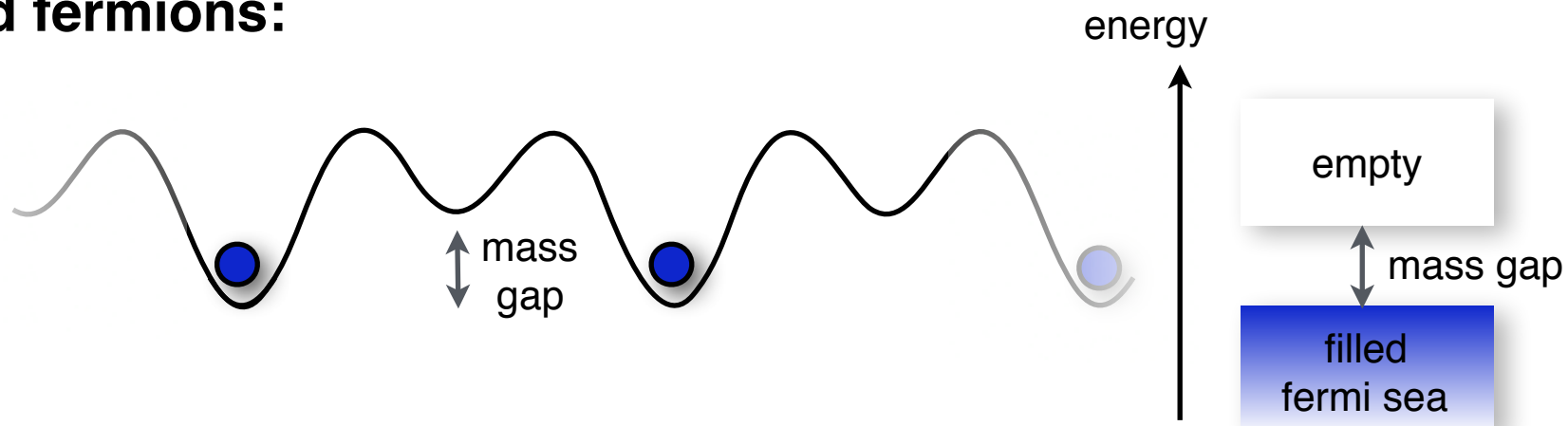

# Schwinger: Quantum Link Model

- **Hamiltonian**

$$H = -t \sum_x \left[ \psi_{x+1}^\dagger S_{x,x+1}^+ \psi_x + \text{h.c.} \right] + m \sum_x (-1)^x \psi_x^\dagger \psi_x + \frac{g^2}{2} \sum_x (S_{x,x+1}^z)^2$$

hopping

staggered fermions

electric field energy



## Staggered fermions:

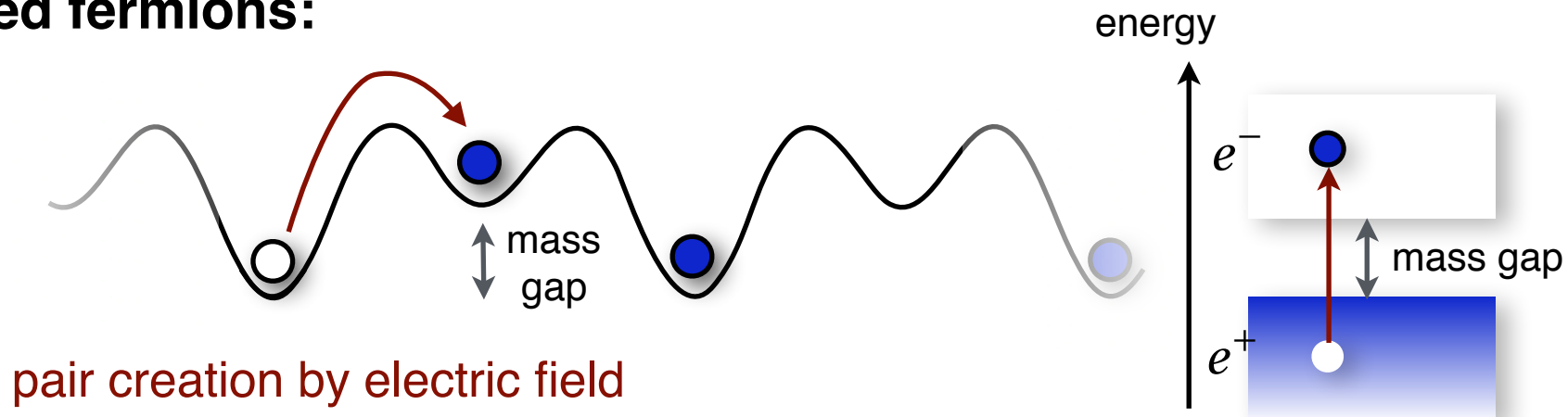

pair creation by electric field

# Schwinger: Quantum Link Model

- **Gauss Law**

$$\tilde{G}_x = \psi_x^\dagger \psi_x + E_{x,x+1} - E_{x-1,x} + \frac{(-1)^x - 1}{2} \leftrightarrow \nabla \cdot E = \rho$$

$$[H, \tilde{G}_x] = 0$$

$$\tilde{G}_x |\text{physical states}\rangle = 0$$

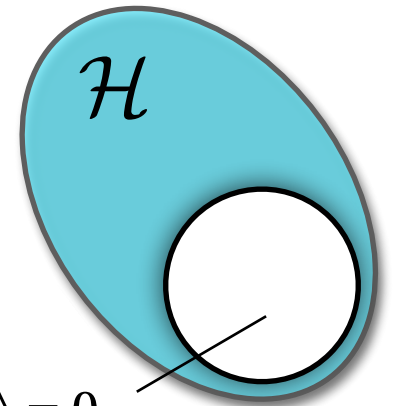

- **Example: Spin 1**



Even sites

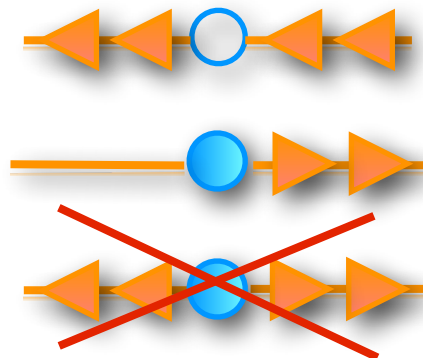

Odd sites

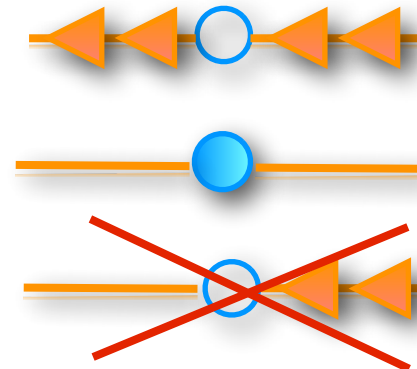

# Schwinger: Quantum Link Model

- Spin as Schwinger boson



spin  $S=1/2, 1, \dots$

# Schwinger: Quantum Link Model

- Spin as Schwinger boson

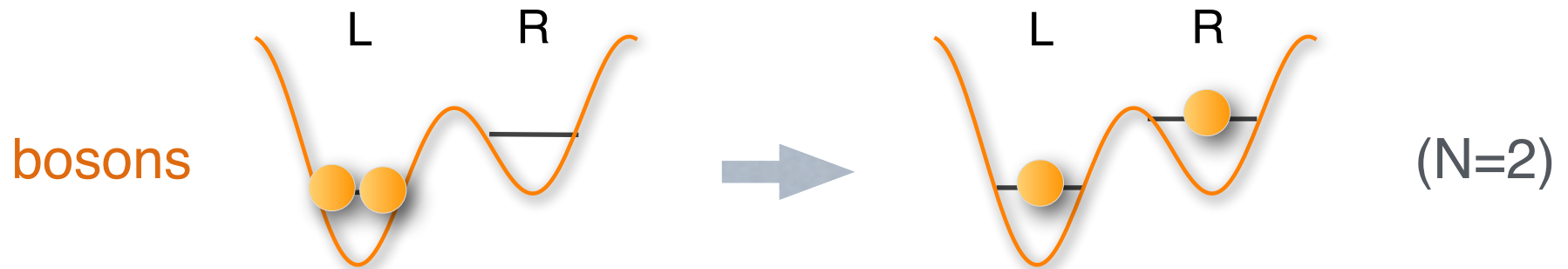

N bosons in double well ( $S=N/2$ )

$$S_{x,y}^+ = b_L^\dagger b_R$$

$$S_{x,y}^z = \frac{1}{2} (b_R^\dagger b_R - b_L^\dagger b_L)$$

Hamiltonian

$$h_B = \underbrace{-t_B (S_{x,y}^+ + \text{h.c.})}_{\text{hopping}} + \underbrace{U_B (S_{x,y}^z)^2}_{\text{electric energy}}$$

# Schwinger: Quantum Link Model

- **Correlated hopping**

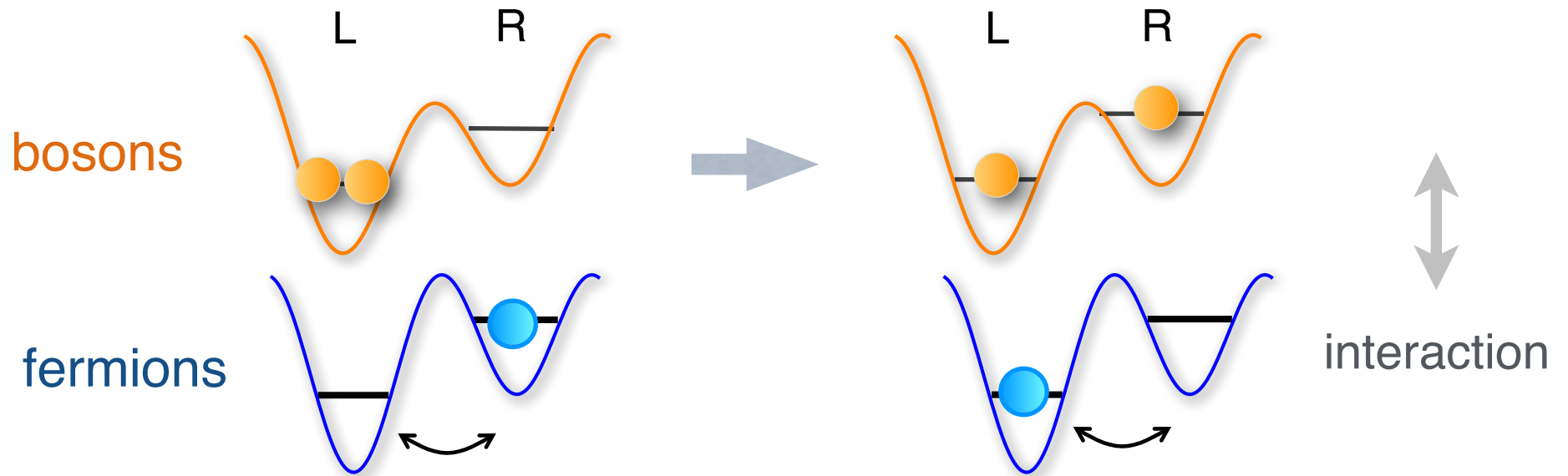

$$H = -\frac{t_B t_F}{U} \psi_x^\dagger b_R^\dagger b_L \psi_y + \text{h.c.}$$

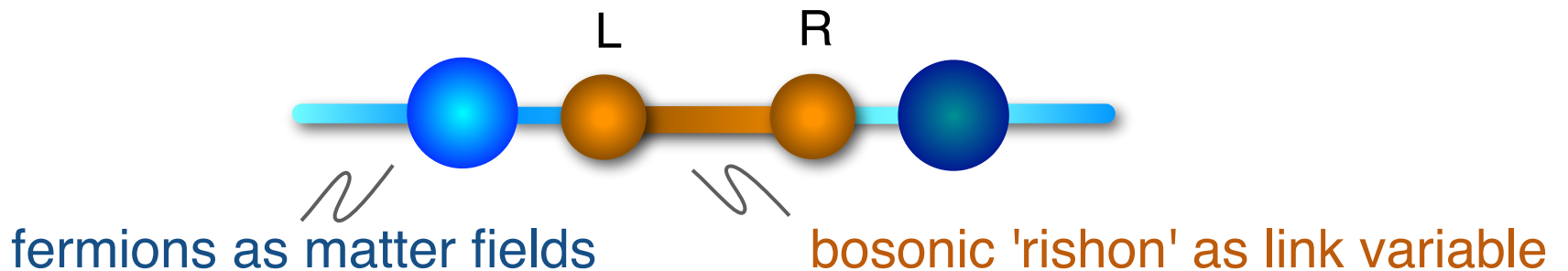



# Schwinger: Quantum Link Model

- **Bosonic 'Rishons'**

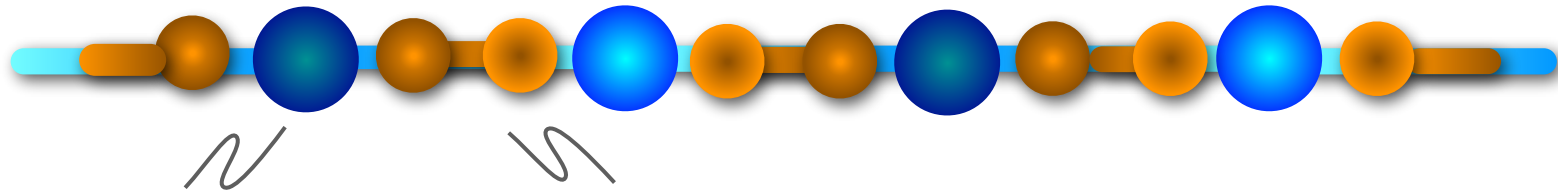

fermions as matter fields

bosonic 'rishons' as link variable

$$H = -\frac{t_B t_F}{U} \psi_x^\dagger b_R^\dagger b_L \psi_y + \text{h.c.}$$

## Non-Abelian Quantum Link Model with Fermionic Rishons

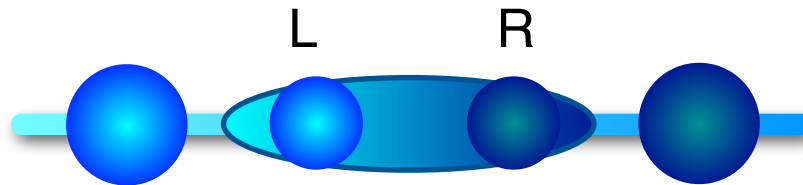

$$U^{ij} = c_R^i c_L^{j\dagger}$$

representation as *fermionic* rishons

# Schwinger: Quantum Link Model

- **Bosonic 'Rishons'**

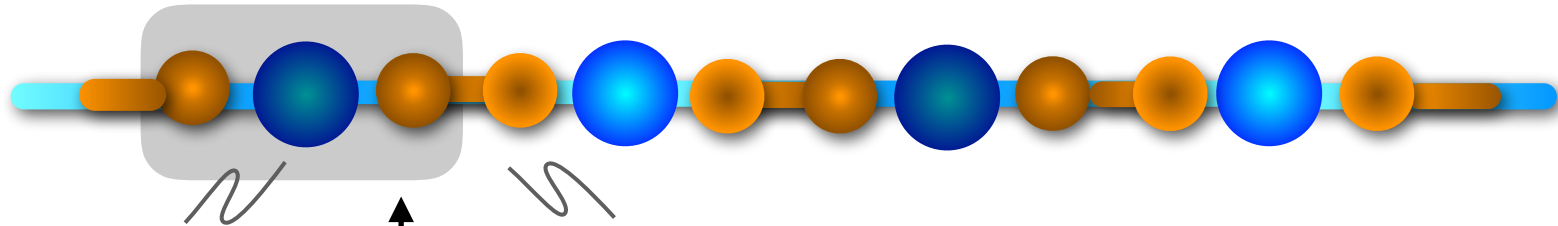

fermions as matter fields

bosonic 'rishons' as link variable

**Gauss constraint**

$$\tilde{G}_x = n_x^F + n_x^1 + n_x^2 - 2S + \frac{1}{2} [(-1)^x - 1] \quad \text{"super-Mott insulator"}$$

~ total number of atoms on site x fixed:

# Schwinger: Quantum Link Model

- Bose-Fermi mixtures in superlattices ... implementation

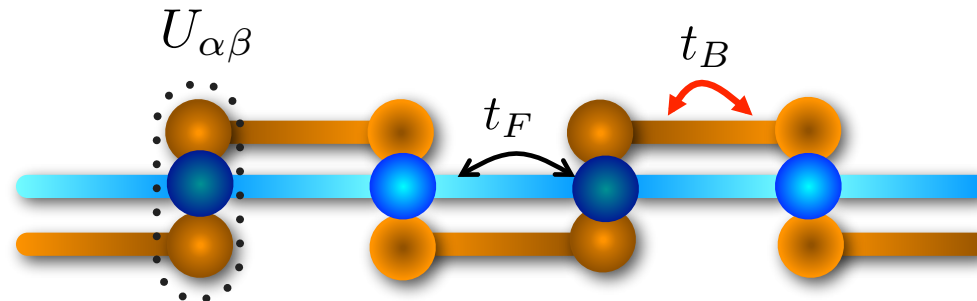

- enforcing the Gauss Law as an *energy constraint*

$$H_{\text{microscopic}} = U \sum_x \tilde{G}_x^2 + \dots$$

Bose + Fermi Hubbard model

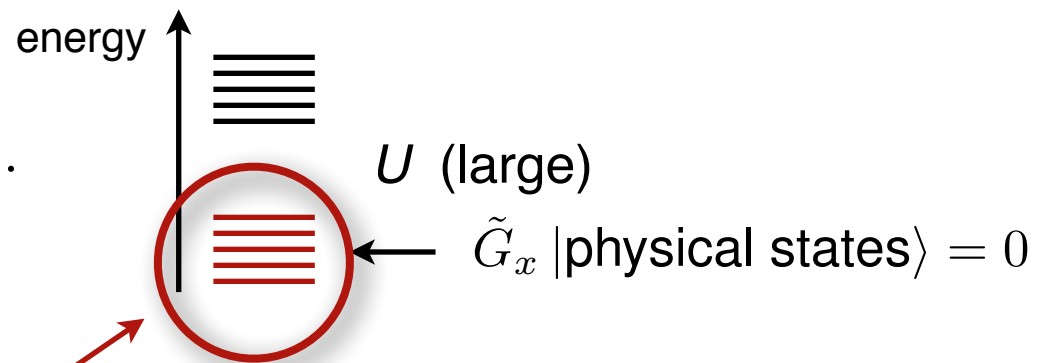

- emergent lattice gauge theory

# String Breaking and Confinement

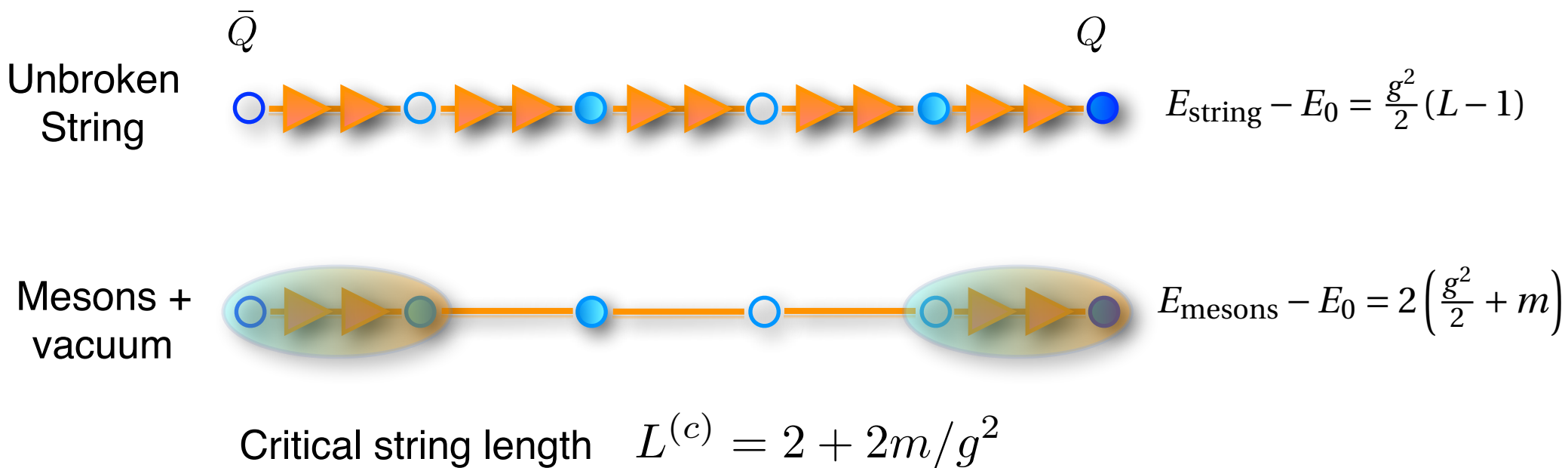
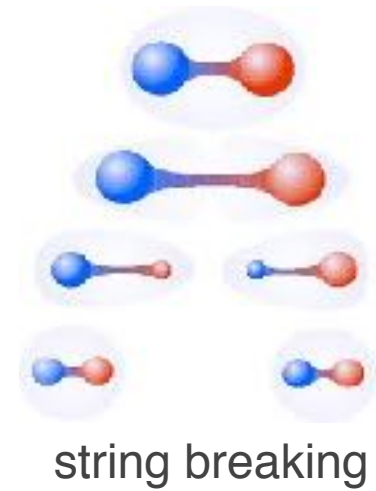

# Real-Time Dynamics in U(1) Lattice Gauge Theories with Tensor Networks

T. Pichler,<sup>1</sup> M. Dalmonte,<sup>2,3</sup> E. Rico,<sup>4,5,6</sup> P. Zoller,<sup>2,3</sup> and S. Montangero<sup>1</sup>

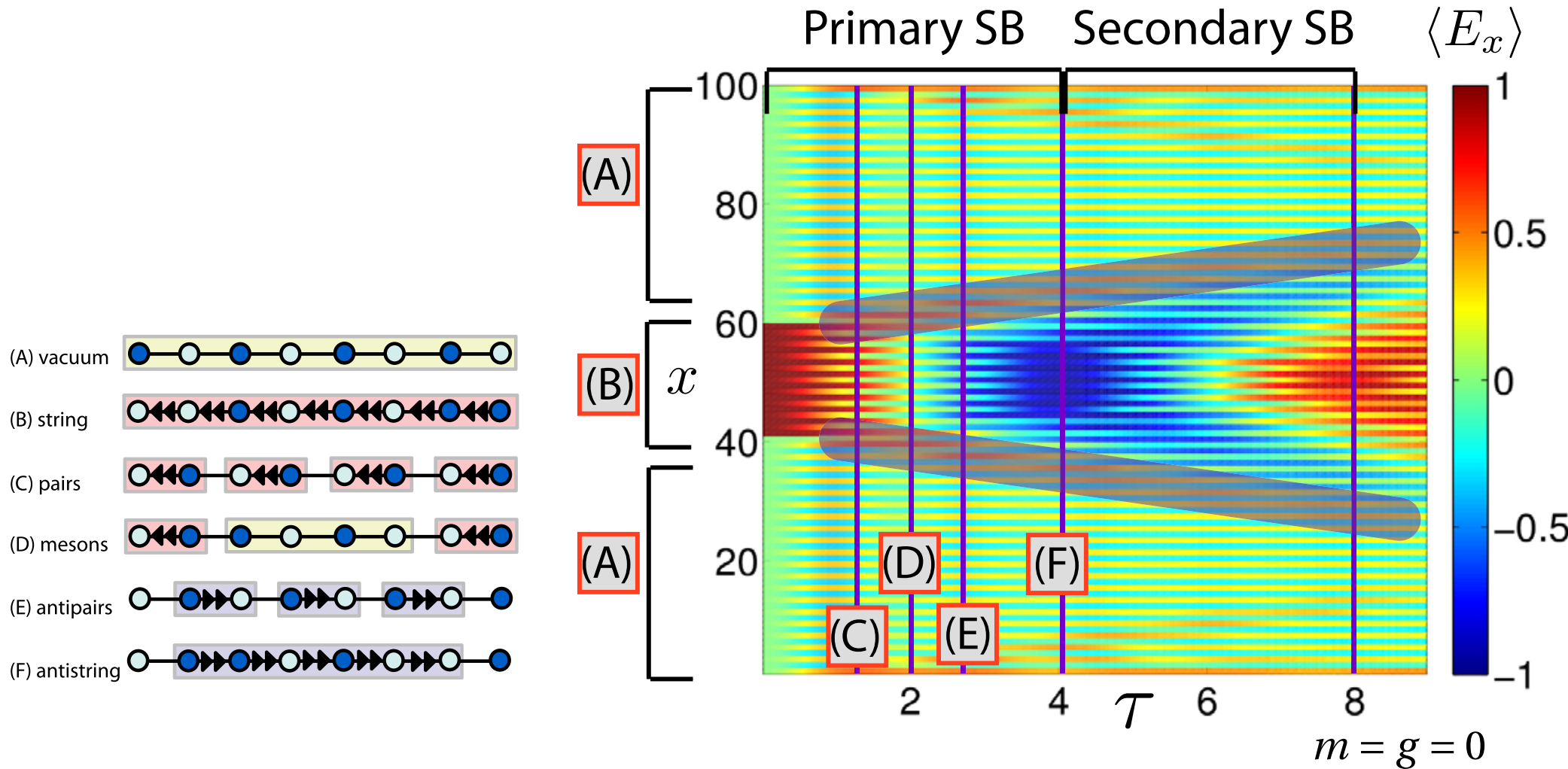

# Real-time dynamics of lattice gauge theories with a few-qubit quantum computer

doi:10.1038/nature18318

Esteban A. Martinez<sup>1\*</sup>, Christine A. Muschik<sup>2,3\*</sup>, Philipp Schindler<sup>1</sup>, Daniel Nigg<sup>1</sup>, Alexander Erhard<sup>1</sup>, Markus Heyl<sup>2,4</sup>, Philipp Hauke<sup>2,3</sup>, Marcello Dalmonte<sup>2,3</sup>, Thomas Monz<sup>1</sup>, Peter Zoller<sup>2,3</sup> & Rainer Blatt<sup>1,2</sup>

## Schwinger pair production

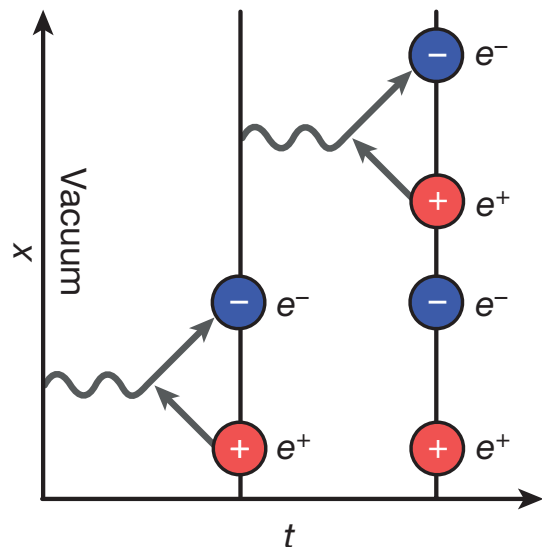

## ion trap quantum computer

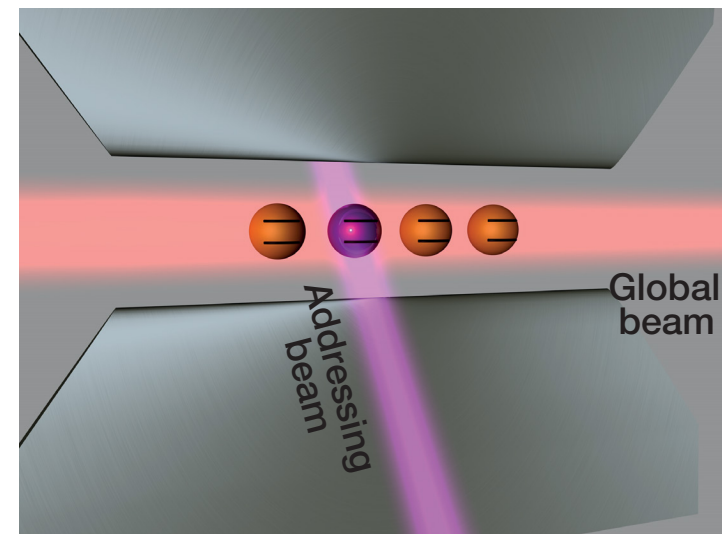

## Schwinger Model: 1+1D QED



$$\hat{H}_{\text{lat}} = -i w \sum_{n=1}^{N-1} \left[ \hat{\Phi}_n^\dagger e^{i\hat{\theta}_n} \hat{\Phi}_{n+1} - \text{h.c.} \right] + J \sum_{n=1}^{N-1} \hat{L}_n^2 + m \sum_{n=1}^N (-1)^n \hat{\Phi}_n^\dagger \hat{\Phi}_n$$

Kogut-Susskind Hamiltonian (Wilson LGT)

## 2. Schwinger Model on a Lattice [Wilson]

- Hamiltonian: Kogut-Susskind (1975)

$$\hat{H} = -i w \sum_{n=1}^{N-1} \left[ \hat{\Phi}_n^\dagger e^{i\hat{\theta}_n} \hat{\Phi}_{n+1} - \text{h.c.} \right] + J \sum_{n=1}^{N-1} \hat{L}_n^2 + m \sum_{n=1}^N (-1)^n \hat{\Phi}_n^\dagger \hat{\Phi}_n$$

$$w = \frac{1}{2a}$$

$$J = \frac{g^2 a}{2}$$

Peierls substitution

electric energy ~rigid rotor  $\sim E^2$

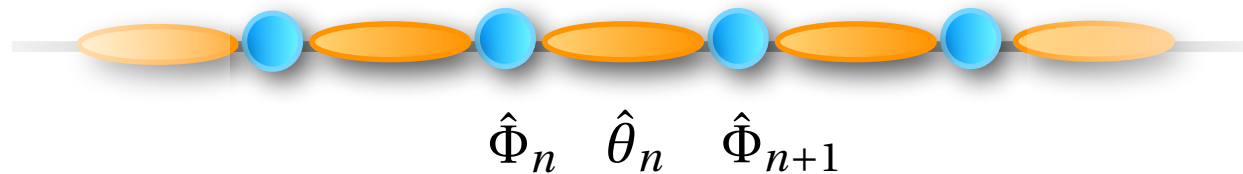

$\hat{\Phi}_n$  fermionic matter field

$$[\hat{\theta}_n, \hat{L}_m] = i\delta_{n,m} \longrightarrow [\theta_n, -i\frac{\partial}{\partial\theta_n}] = i\delta_{n,m}$$

vector potential

electric field

# Schwinger Model on a Lattice

- **Jordan-Wigner transformation:**  $\hat{\Phi}_n = \prod_{l < n} [i\hat{\sigma}_l^z] \hat{\sigma}_n^-$ ,  $\hat{\Phi}_n^\dagger = \prod_{l < n} [-i\hat{\sigma}_l^z] \hat{\sigma}_n^+$

$$\hat{H}_{\text{spin}} = +w \sum_{n=1}^{N-1} \left[ \hat{\sigma}_n^+ e^{i\hat{\theta}_n} \hat{\sigma}_{n+1}^- + \text{h.c.} \right] + J \sum_{n=1}^{N-1} \hat{L}_n^2 + \frac{m}{2} \sum_{n=1}^N (-1)^n \hat{\sigma}_n^z$$

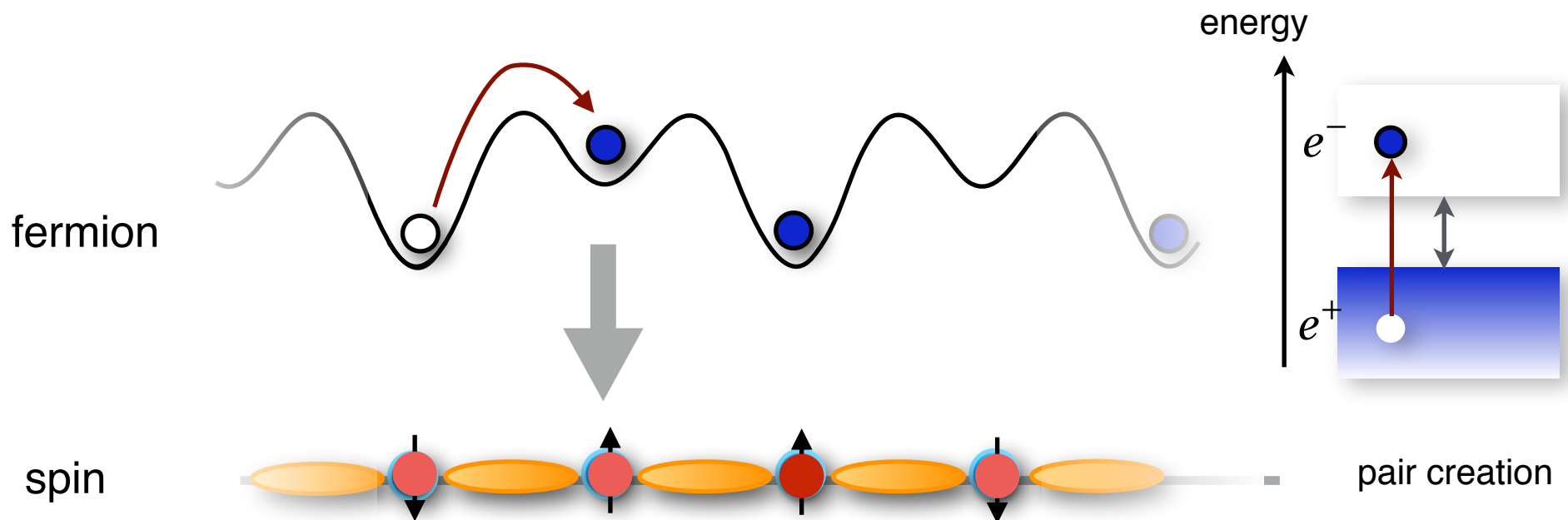

$$\begin{array}{lll} |0000\rangle = |\uparrow\downarrow\uparrow\downarrow\rangle & |e^-e^+00\rangle = |\downarrow\uparrow\uparrow\downarrow\rangle & |0e^+e^-0\rangle = |\uparrow\uparrow\downarrow\downarrow\rangle \\ |00e^-e^+\rangle = |\uparrow\downarrow\downarrow\uparrow\rangle & |e^-00e^+\rangle = |\downarrow\downarrow\uparrow\uparrow\rangle & |e^-e^+e^-e^+\rangle = |\downarrow\uparrow\downarrow\uparrow\rangle \end{array}$$



# Schwinger Model as 'Exotic Spin Model'

- **gauge transformation:** we eliminate gauge field  $\hat{\sigma}_n^- \rightarrow \prod_{l < n} \left[ e^{-i\hat{\theta}_l} \right] \hat{\sigma}_n^-$

$$\hat{H}_S = +\frac{m}{2} \sum_{n=1}^N (-1)^n \hat{\sigma}_n^z + w \sum_{n=1}^{N-1} [\hat{\sigma}_n^+ \hat{\sigma}_{n+1}^- + \text{h.c.}]$$

$$+ J \sum_{n=1}^{N-1} \left[ \epsilon_0 + \frac{1}{2} \sum_{m=1}^n [\hat{\sigma}_m^z + (-1)^m] \right]^2$$

$$\epsilon_0 = 0$$

$$\hat{L}_n - \hat{L}_{n-1} = \frac{1}{2} [\hat{\sigma}_n^z + (-1)^n]$$

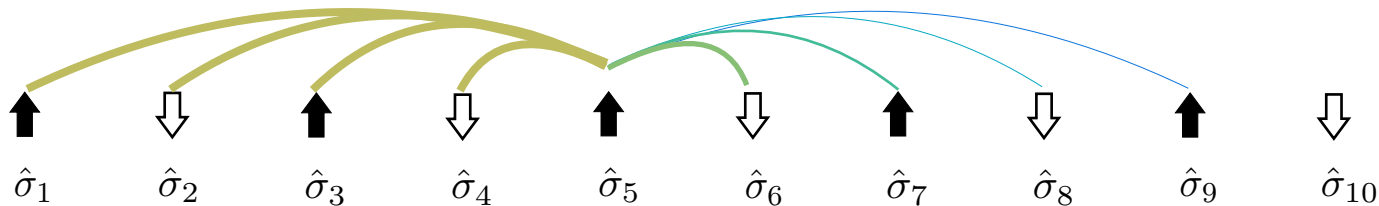

# Schwinger Model as 'Exotic Spin Model'

- Spin model with exotic long range interactions

$$\hat{H}_S = J \sum_{i < j} c_{ij} \hat{\sigma}_i^z \hat{\sigma}_j^z$$

long - range interaction

$$+ w \sum_i (\hat{\sigma}_i^+ \hat{\sigma}_{i+1}^- + \hat{\sigma}_{i+1}^+ \hat{\sigma}_i^-)$$

particle - antiparticle creation/annihilation

$$+ m \sum_i c_i \hat{\sigma}_i^z + J \sum_i \tilde{c}_i \hat{\sigma}_i^z$$

effective particle masses

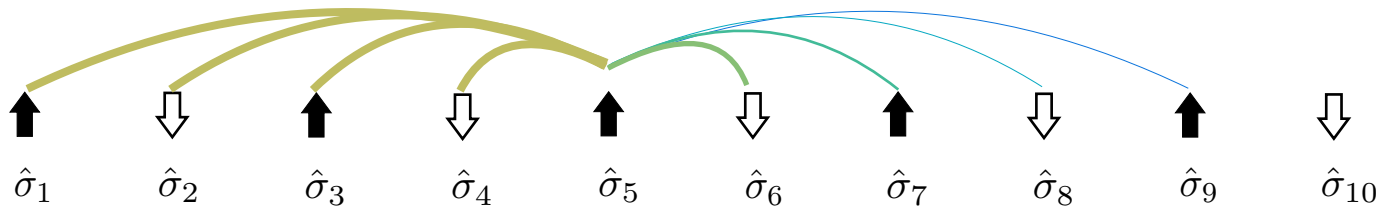
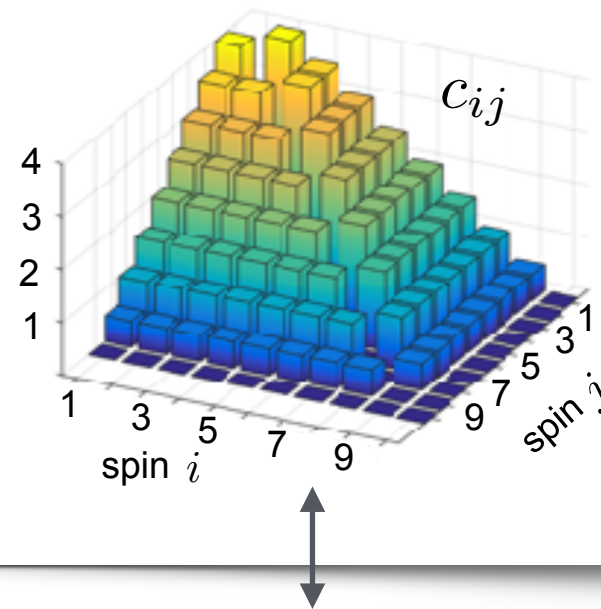

... efficient to program on an ion trap quantum computer

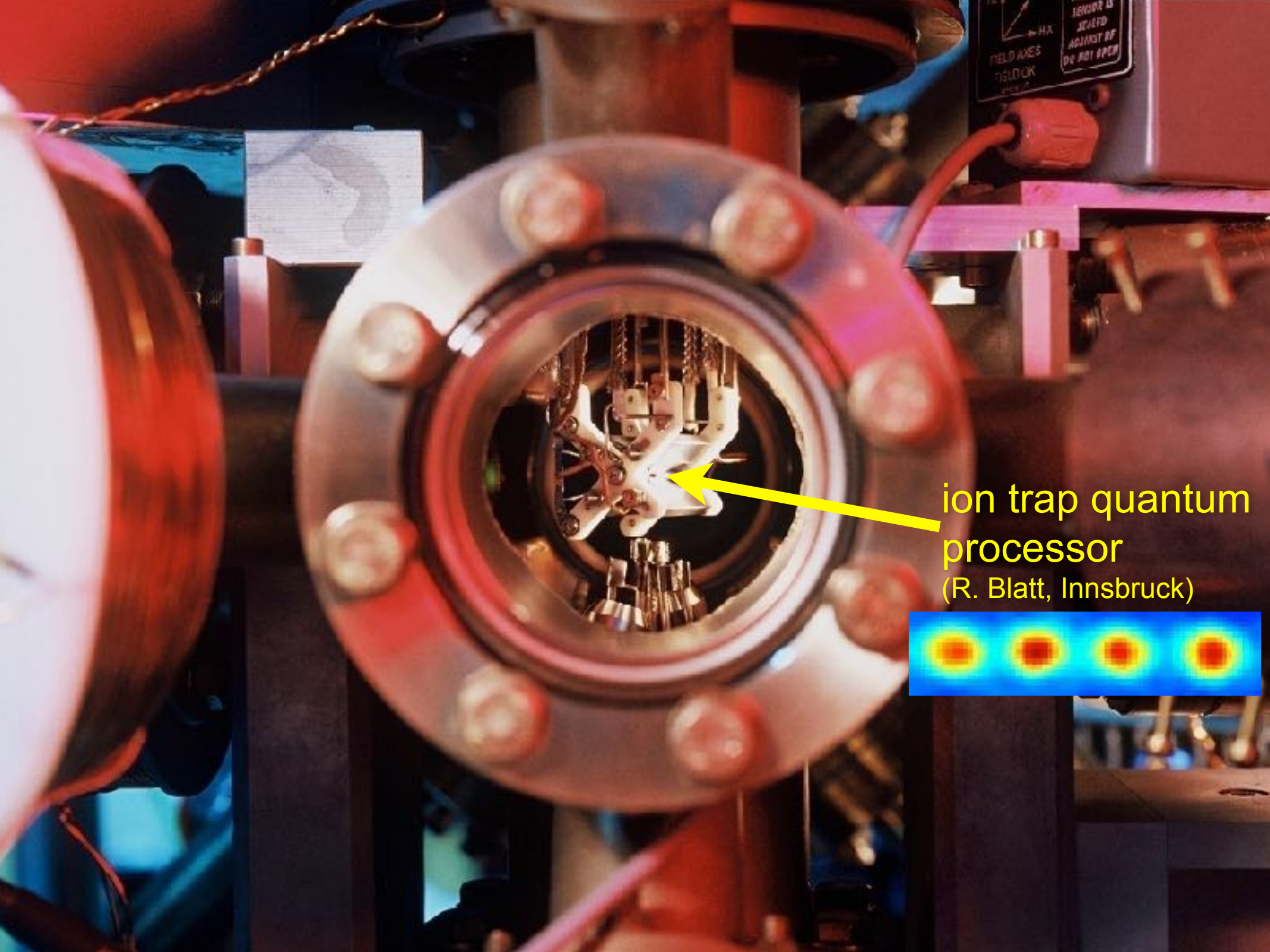

ion trap quantum processor  
(R. Blatt, Innsbruck)

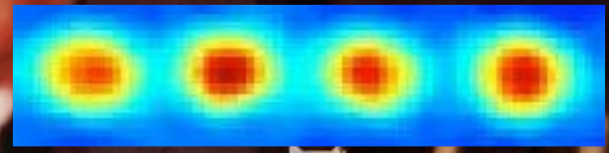

# Quantum Info

- universal quantum computing

quantum logic network model

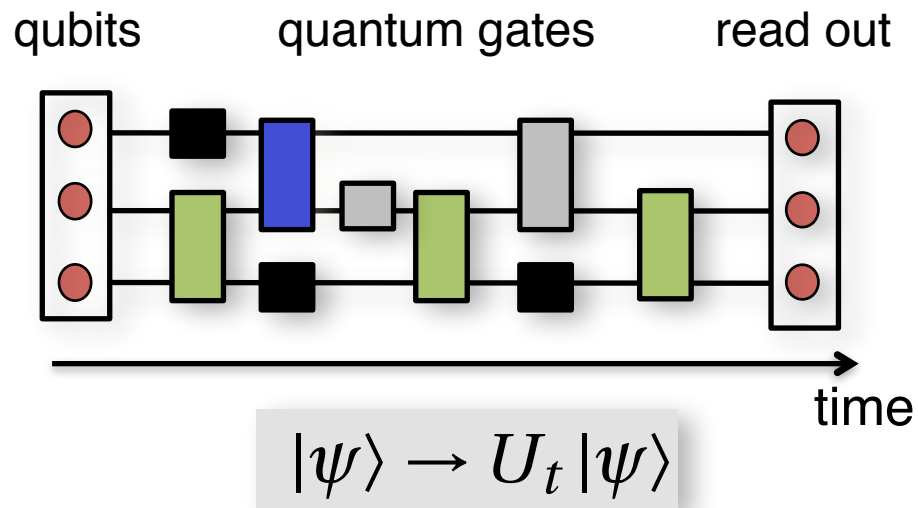

# Quantum Optics

- ion trap quantum computer

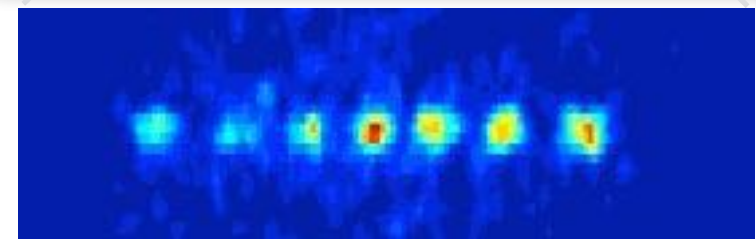
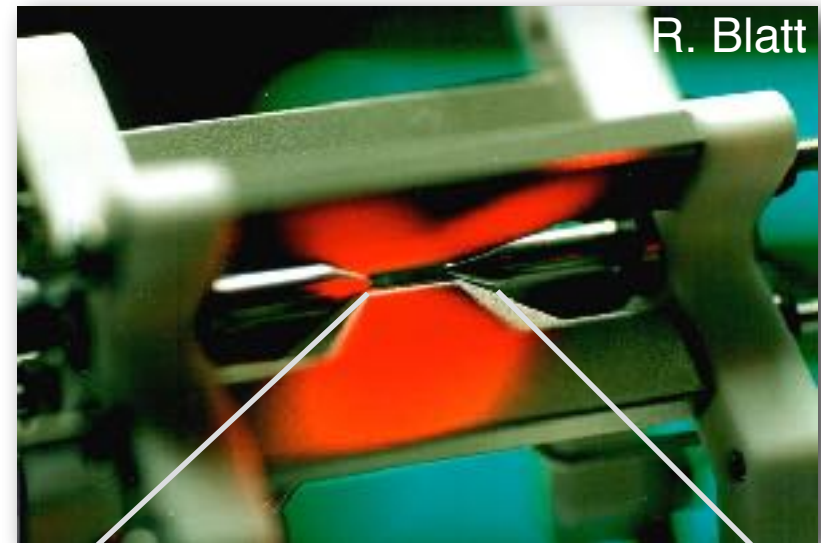

Innsbruck, NIST, JQI, Oxford, Mainz ...

# Quantum Info

- universal quantum computing

quantum logic network model

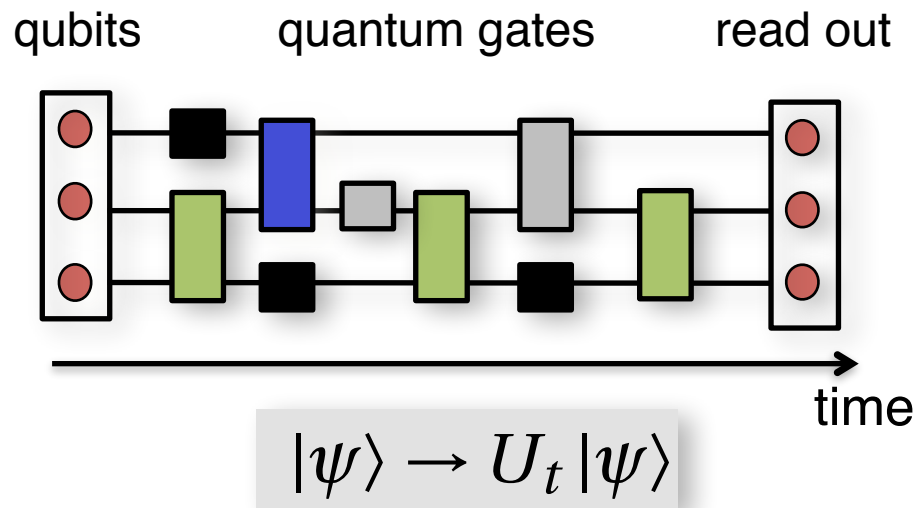

# Quantum Optics

- ion trap quantum computer

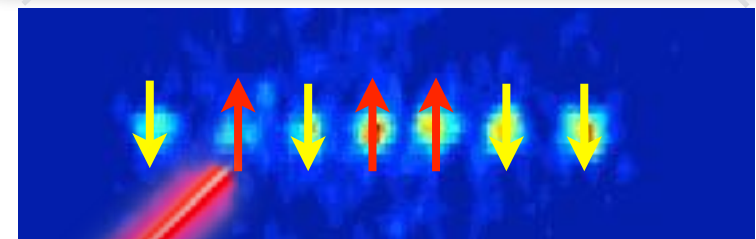
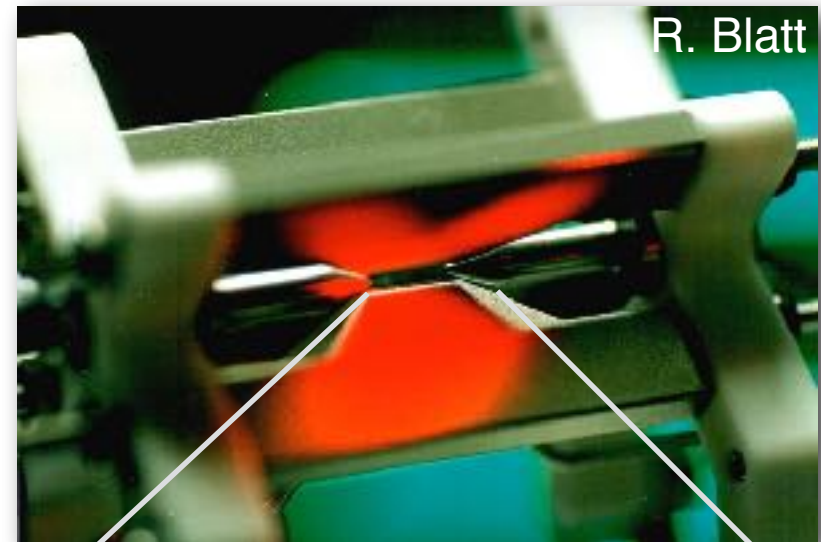

laser

# Quantum Info

- universal quantum computing

quantum logic network model

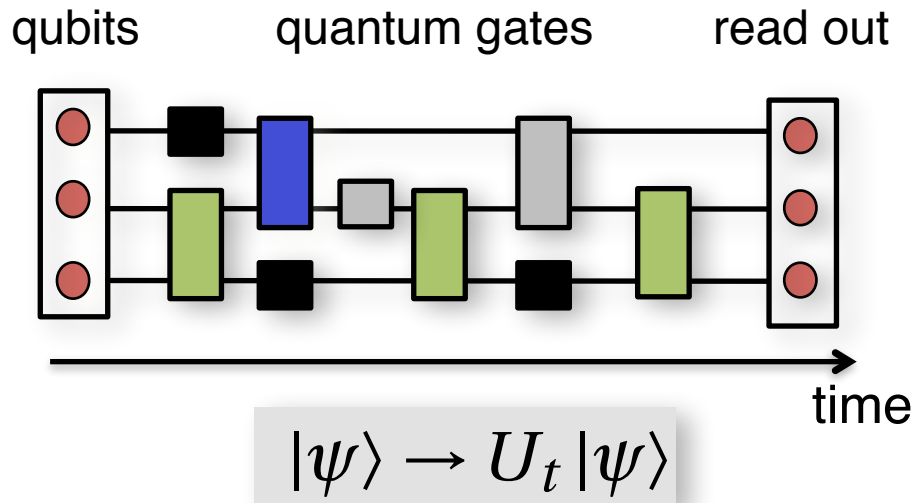

# Quantum Optics

- ion trap quantum computer

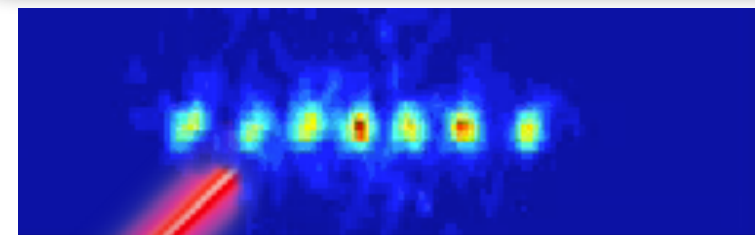
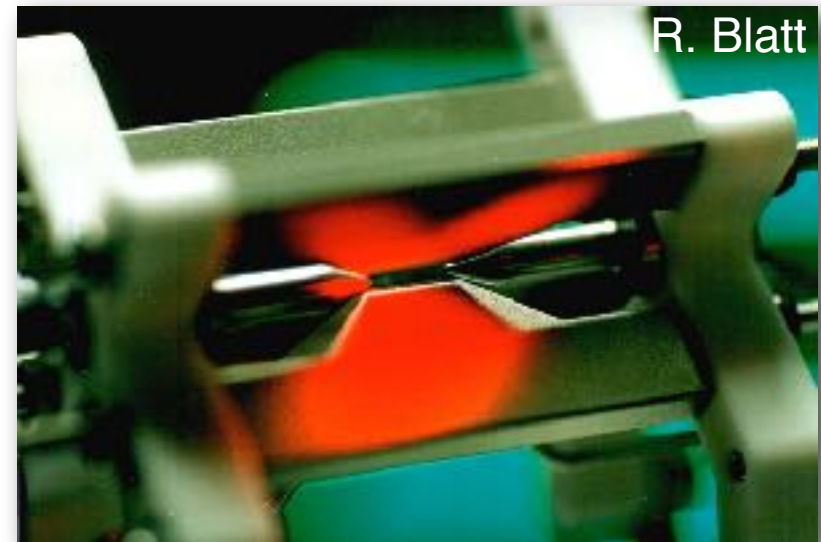

phonon bus

laser

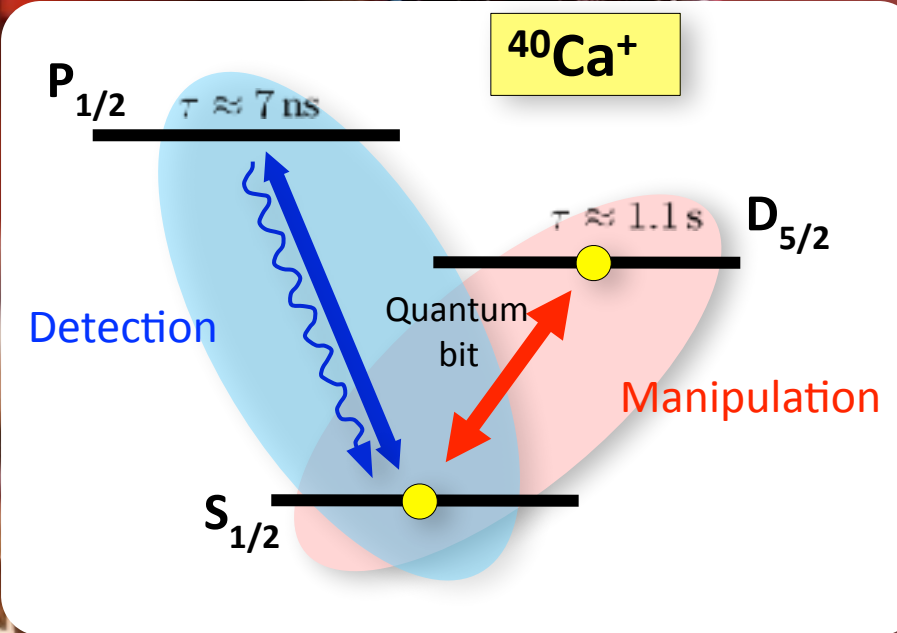
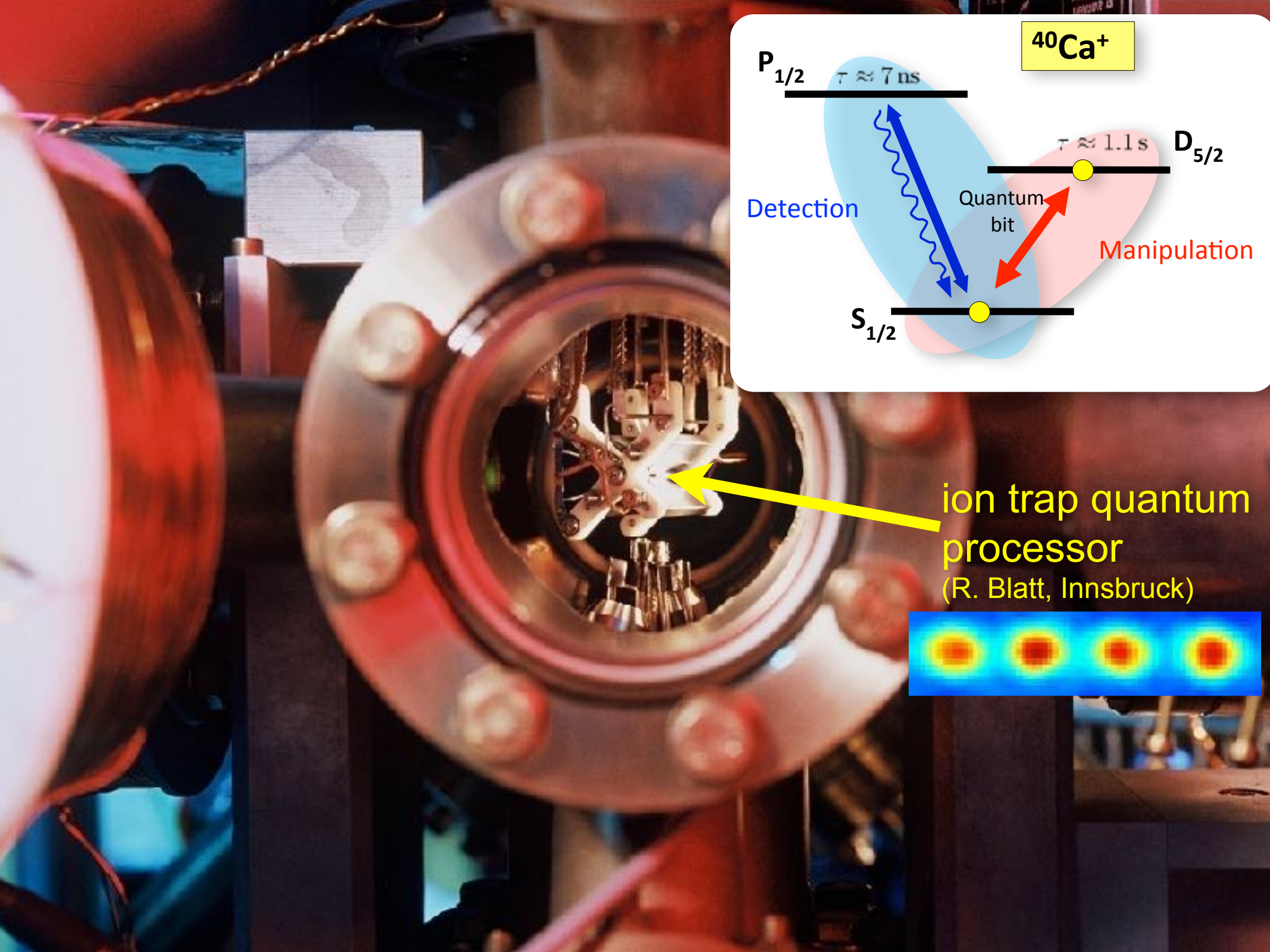

ion trap quantum processor  
(R. Blatt, Innsbruck)

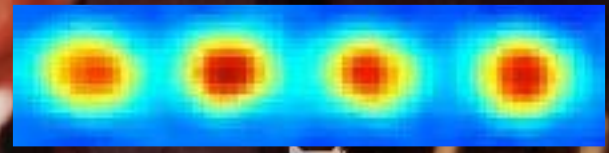

# Quantum operations & compiler: Innsbruck ion-trap quantum computer



Collective spin flips  
 $S_x, S_y$

Mølmer-Sørensen gate  
 $S_x^2 = \sigma_x^{(0)}\sigma_x^{(1)} + \sigma_x^{(1)}\sigma_x^{(2)} + \sigma_x^{(0)}\sigma_x^{(2)}$

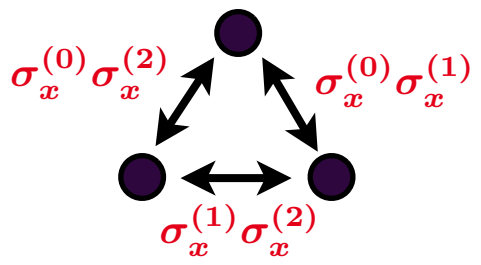

Individual light-shift gates  
 $\sigma_z^{(0)}, \sigma_z^{(1)}, \sigma_z^{(2)}$

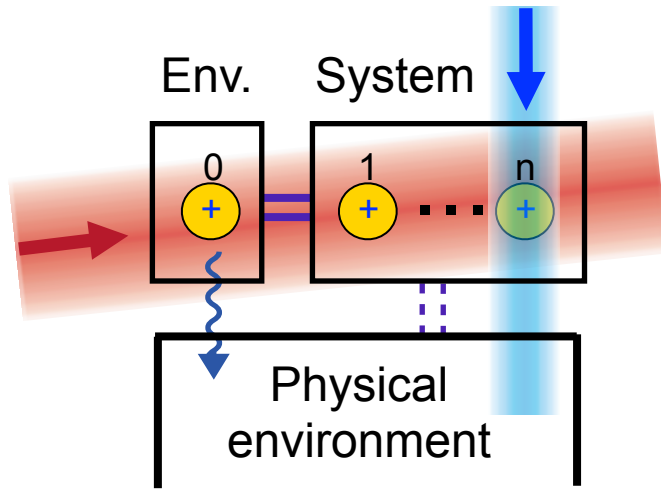

Coupling of environment with physical environment

Optical pumping of „environmental“ ion



# Digital Quantum Simulation



S. Lloyd 1996

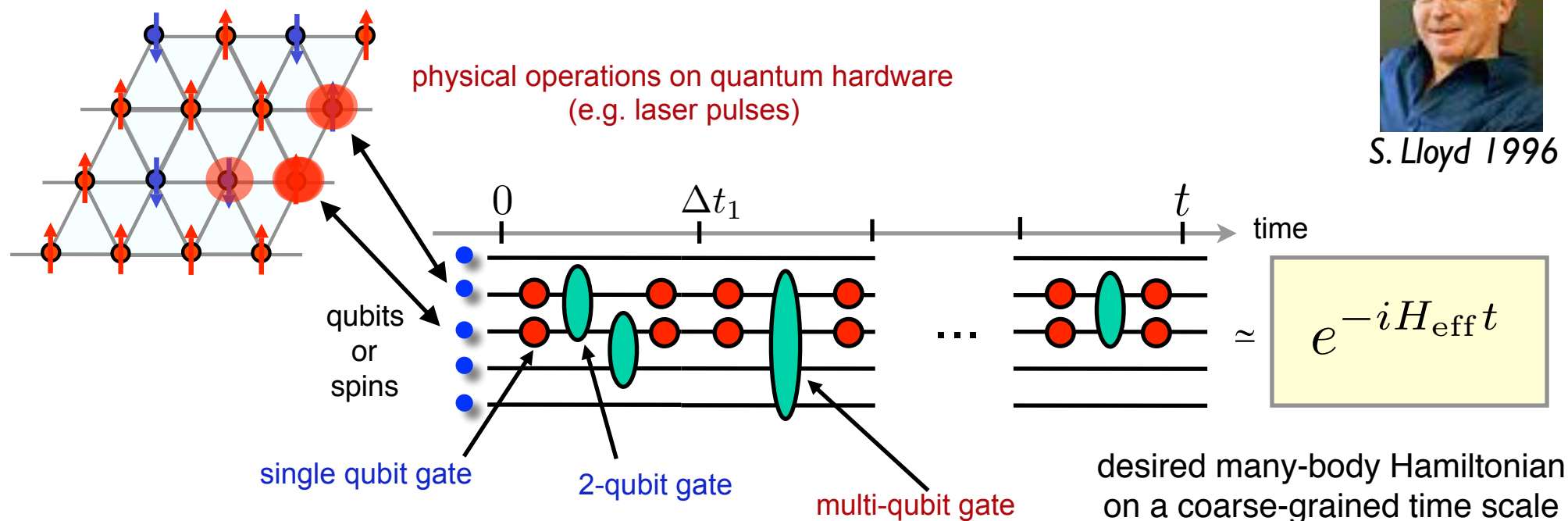

idea: approximate time evolution by a stroboscopic sequence of gates

$$U(t) \equiv e^{-iHt/\hbar} = e^{-iH\Delta t_n/\hbar} \dots e^{-iH\Delta t_1/\hbar}$$

Trotter expansion:

$$e^{-iH\Delta t/\hbar} \simeq \underbrace{e^{-iH_1\Delta t/\hbar}}_{\text{first term}} \underbrace{e^{-iH_2\Delta t/\hbar}}_{\text{second term}} \underbrace{e^{\frac{1}{2} \frac{(\Delta t)^2}{\hbar^2} [H_1, H_2]}}_{\text{Trotter errors for non-commuting terms}}$$

$$H = -J\sigma_1^z\sigma_2^z + B(\sigma_1^x + \sigma_2^x)$$

... not restricted to unitary dynamics

# Real-time dynamics of lattice gauge theories with a few-qubit quantum computer

## Schwinger Mechanism

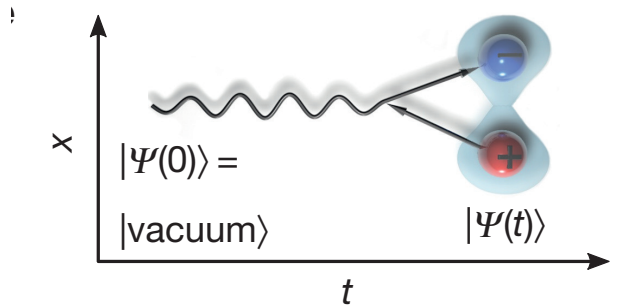

## Time evolution particle density

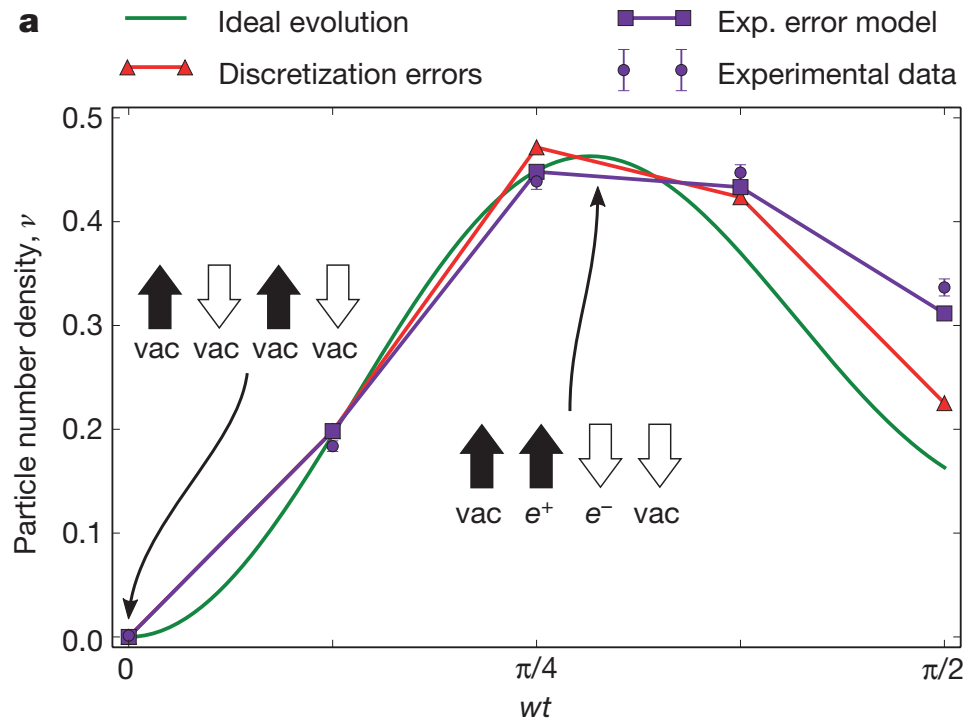

### Experiment

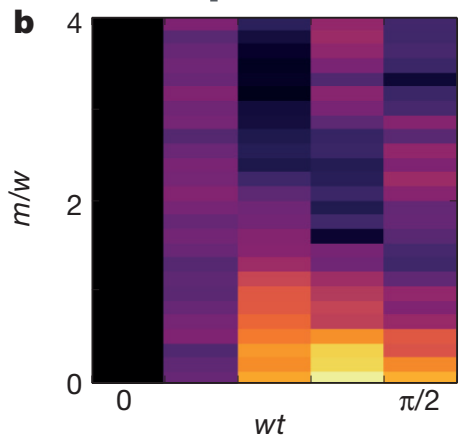

### Theory

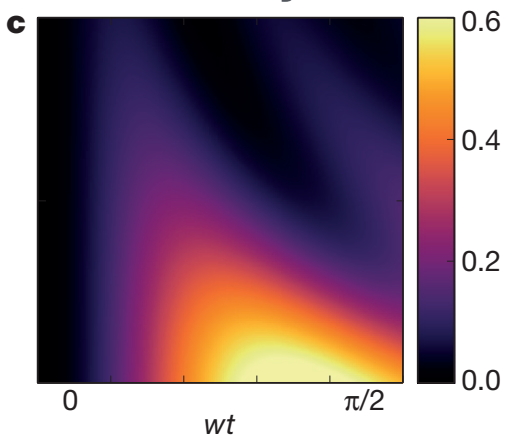

Particle number density:

$$\nu(t) = \frac{1}{N} \sum_{n=1}^N \langle (-1)^n \sigma_n^z(t) + 1 \rangle$$

# Real-time dynamics of lattice gauge theories with a few-qubit quantum computer

## Entanglement

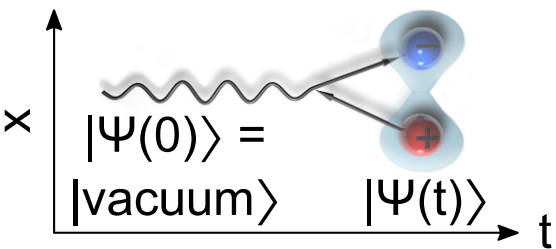

State tomography:  
access to the full density matrix

$E_n$  : logarithmic negativity  
evaluated with respect to this bipartition:

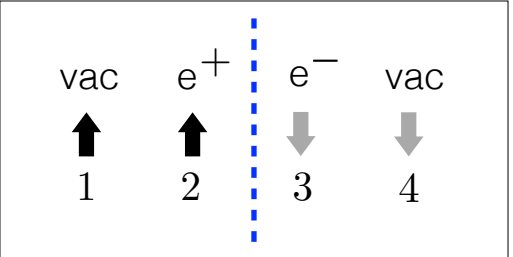

Entanglement between the two halves of the system.

Entanglement

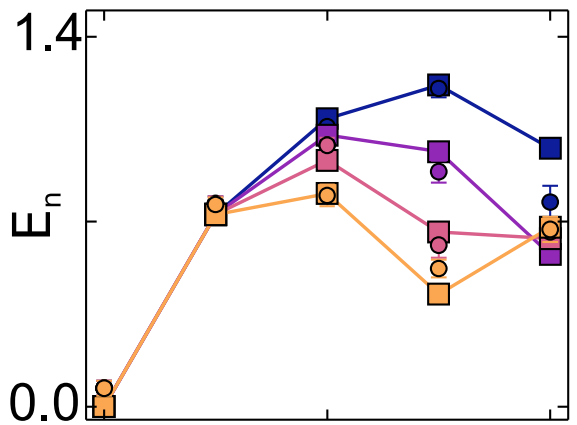

Mass dependence

$m/w = 0$
0.5
1
1.5

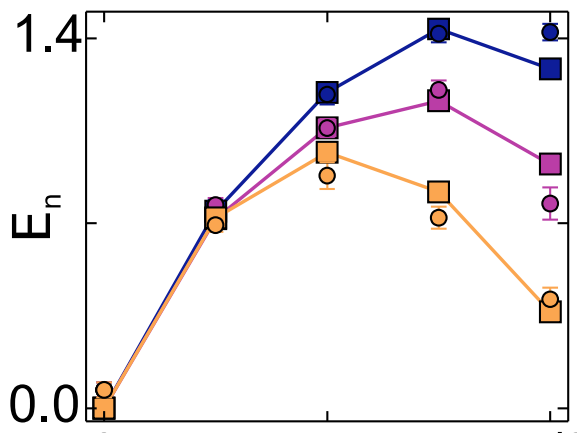

E field dependence

$J/w = 0$
1
2

● Experimental data  
■ Error model

# Quantum Spin Ice with Cold Rydberg Atoms



A. Glätzle

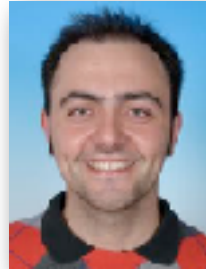

M. Dalmonte



R. Nath



I Bloch & C Gross@MPQ



Laser excited Rydberg atoms

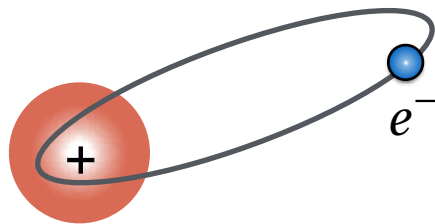

condensed matter physics



*quantum* spin ice, spin liquids,  
frustrated magnetism, ...

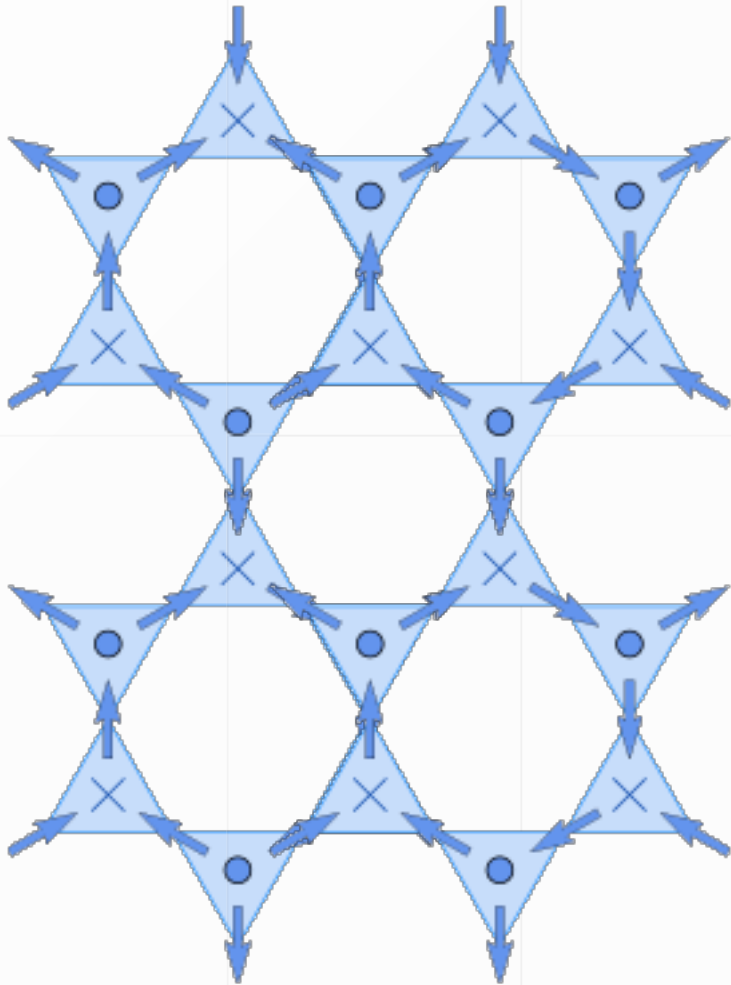

### Anisotropic Heisenberg Model

$$H = \sum_{\substack{i,j=1 \\ i < j}}^N \left[ J_z(\mathbf{r}_{ij}) S_z^{(i)} S_z^{(j)} + \frac{J_{+-}(\mathbf{r}_{ij})}{2} (S_+^{(i)} S_-^{(j)} + \text{h.c.}) + \frac{J_{++}(\mathbf{r}_{ij})}{2} (S_+^{(i)} S_+^{(j)} + \text{h.c.}) \right]$$

Quantum Simulation of Exotic Quantum Magnetism with Atoms or Ions?

# Single-Atom Trapping in Holographic 2D Arrays of Microtraps with Arbitrary Geometries

F. Nogrette, H. Labuhn, S. Ravets, D. Barredo, L. Béguin, A. Vernier, T. Lahaye, and A. Browaeys  
*Laboratoire Charles Fabry, UMR 8501, Institut d'Optique, CNRS, Univ Paris Sud 11,  
2 avenue Augustin Fresnel, 91127 Palaiseau cedex, France*

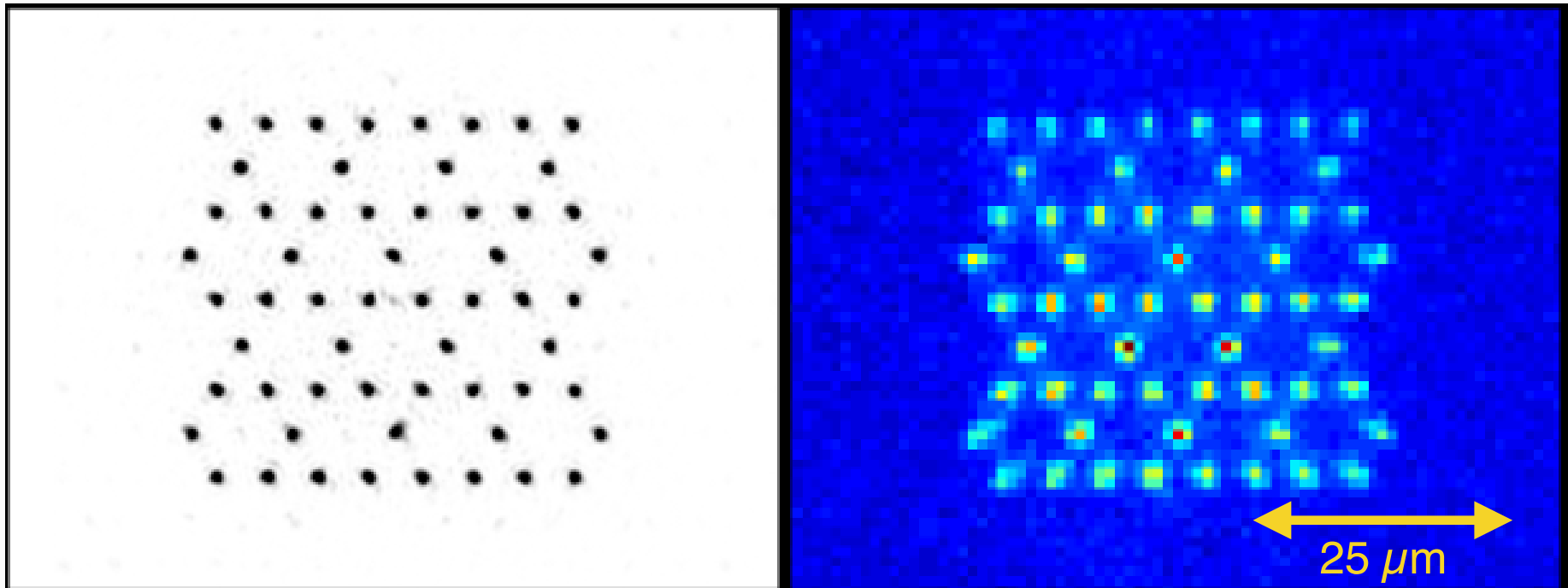

**large spacing optical lattices:**

Palaiseau, Madison, Harvard, Caltech, ...

**Q.: How design spin-spin interactions?**

- ▶ *arbitrary* interaction patterns
- ▶ *large* interactions ( $\sim$  temperature)

# Quantum Kagome Ice [Frustrated Magnetism]

## 2D spin liquid in quantum kagome ice

J Carrasquilla, Z Hao & RG Melko,  
Nature Comm 2015

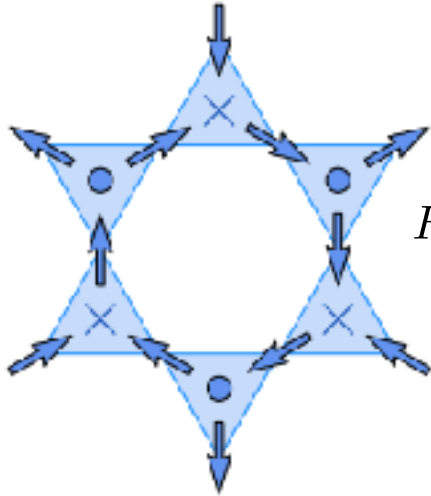

$$H_{ij} \simeq J^{++}(S_i^+ S_j^+ + \text{h.c.}) + J^z S_i^z S_j^z$$

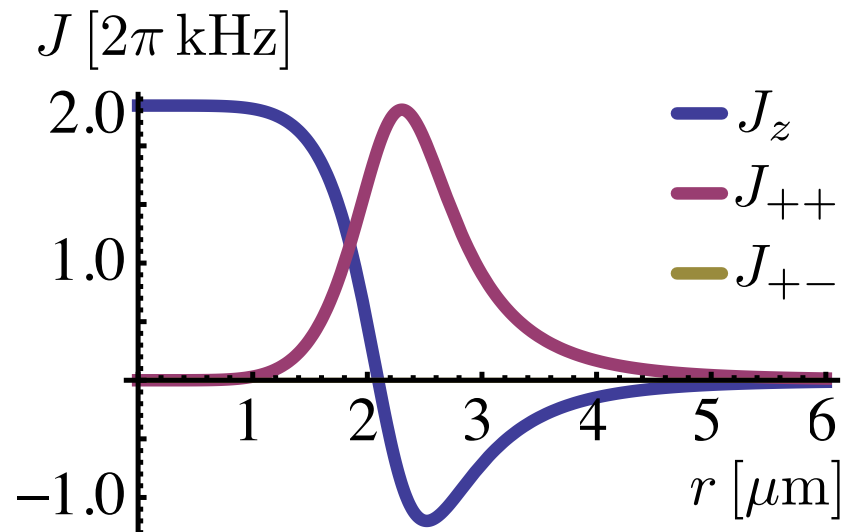
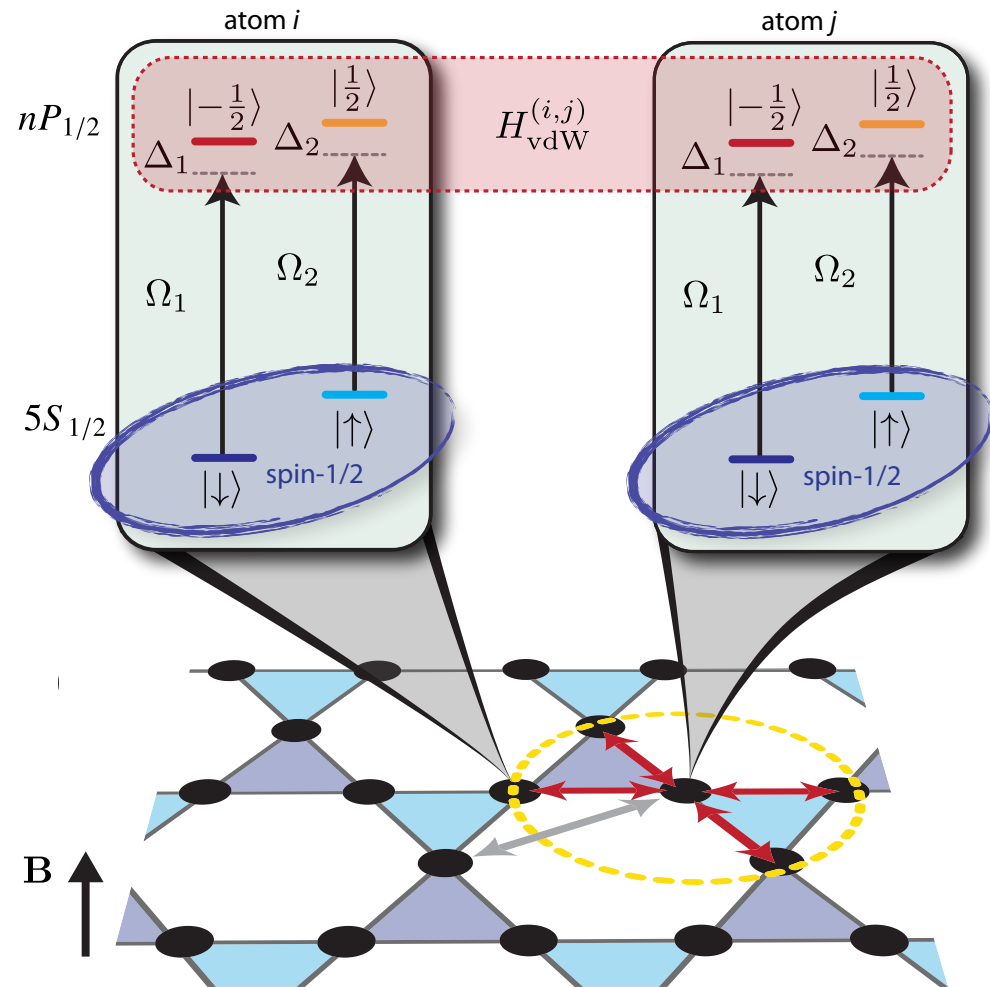

# Conclusion & Outlook

## Quantum Simulation of Lattice Gauge Theories:

### U(1) Abelian LGT

D. Banerjee et al., PRL 2012

“spin ice” QED + matter

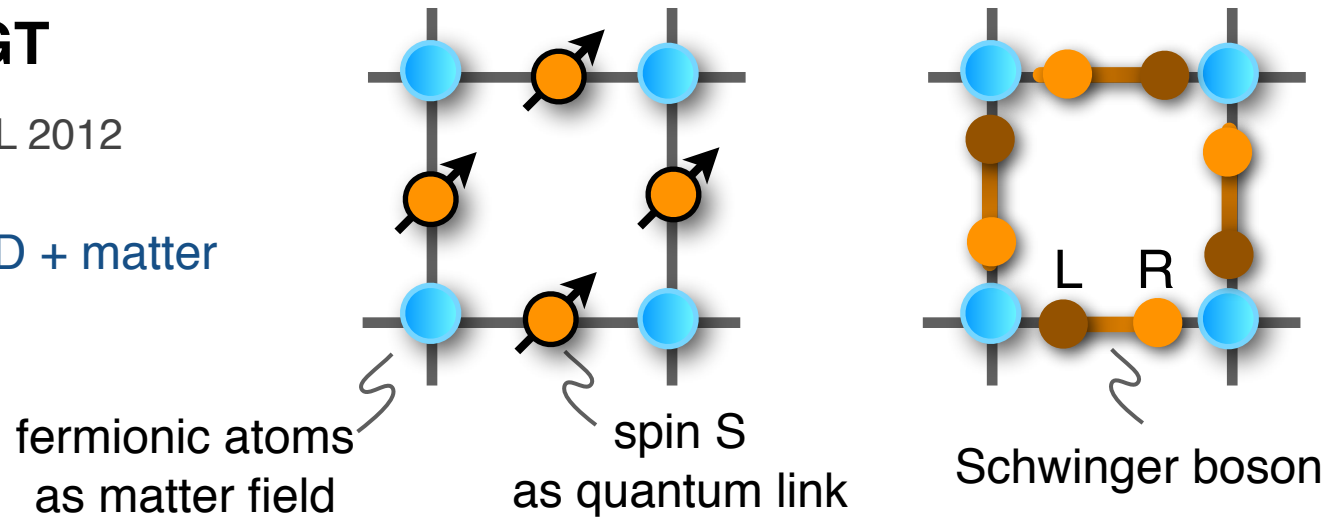

atomic boson-fermi mixtures in optical lattices

### U(N),SU(N) Non-Abelian LGT

D. Banerjee et al., PRL 2013

K. Stannigel et al., PRL 2014

Gauss law by particle  
number conservation

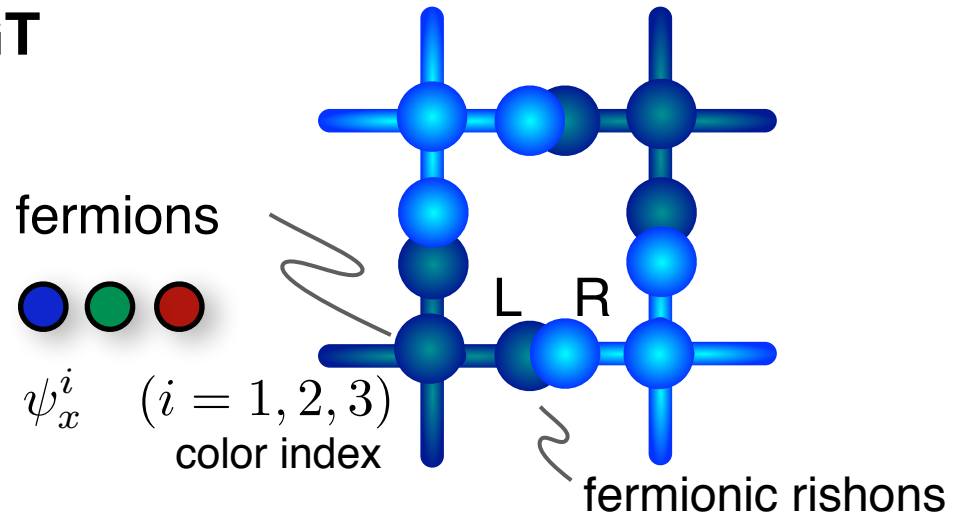

multi-species fermi gases